



U.S. Department  
of Transportation

Federal Aviation  
Administration

# Advisory Circular

---

**Subject:** Airport Design

**Date:** 2/26/2014

**AC No:** AC 150/5300-13A

**Initiated by:** AAS-100

**Change:** 1

---

## 1. What is the purpose of this advisory circular (AC)?

This Change primarily includes updates to the standards for Taxiway Fillet Design.

## 2. What are the principal changes in this Change?

Text revised in this Change is indicated by vertical bars in the margins of the attached consolidated AC. We have not indicated the change number or change date in the headers of revised pages. See the Record of Changes, discussed below, for a log of all revisions made in this Change. Principal changes include:

- a. New Approach and Departure Reference Code (APRC and DPRC) designations replace Runway Reference Code (RRC).
- b. Expanded Taxiway Fillet information, including a new Appendix 8, Taxiway Fillet Design, discussing description, dimensions and transitions.
- c. Adjusted TDG limits, with associated changes to fillet dimensions.
- d. Moved Figure 4-1 to Chapter 1 where it is first referenced.
- e. Combined Tables 3-4 and 3-5 to form Standards for Instrument Approach Procedures.
- f. This Change contains minor editorial corrections.
- g. This Change incorporates a Record of Changes at the end of the consolidated AC. We will log all substantive revisions made in this and subsequent Changes in this Record.
- h. This Change also incorporates revisions described in the Errata Sheets for both the original release and the Change release.

**Michael J. O'Donnell**  
Director of Airport Safety and Standards

**Page intentionally left blank.**



U.S. Department  
of Transportation

Federal Aviation  
Administration

# Advisory Circular

Consolidated AC includes Change 1

**Subject:** Airport Design

**Date:** 9/28/2012

**AC No:** AC 150/5300-13A

**Initiated by:** AAS-100

**Change:**

## 1. What is the purpose of this advisory circular (AC)?

This AC contains the Federal Aviation Administration's (FAA) standards and recommendations for airport design.

## 2. Does this AC cancel any prior ACs?

AC 150/5300-13, Airport Design, dated September 29, 1989, is canceled.

## 3. To whom does this AC apply?

The FAA recommends the standards and recommendations in this AC for use in the design of civil airports. In general, use of this AC is not mandatory. The standards and recommendations contained in this AC may be used by certificated airports to satisfy specific requirements of Title 14 Code of Federal Regulations (CFR) Part 139, Certification of Airports, subparts C (Airport Certification Manual) and D (Operations). Use of this AC is mandatory for all projects funded with federal grant monies through the Airport Improvement Program (AIP) and/or with revenue from the Passenger Facility Charges (PFC) Program. See Grant Assurance No. 34, Policies, Standards, and Specifications, and PFC Assurance No. 9, Standards and Specifications.

## 4. Are there any related documents?

Related documents to this AC are indicated in paragraph [108](#).

## 5. What are the principal changes in this AC?

This AC was substantially revised to fully incorporate all previous Changes to AC 150/5300-13, as well as new standards and technical requirements. This document was reformatted to simplify and clarify the FAA's airport design standards and improve readability. Users should review the entire document to familiarize themselves with the new format. Additional principal changes include:

- a. A new Runway Design Code (RDC) designation

- b. An expanded discussion on Declared Distances
- c. A new Runway Reference Code (RRC) designation
- d. An update to the Runway Protection Zone (RPZ) standards
- e. New Taxiway Design Group (TDG) categories for fillet design
- f. Guidance for intersecting and non-intersecting runway geometry
- g. Expanded discussion on Runway Incursion Prevention geometry for new construction
- h. Consolidation of numerous design tables into one interactive Runway Design Requirements Matrix (Table 3-8)
- i. Consolidation of several Appendices in to the runway and taxiway design chapters
- j. A new Aircraft Characteristics Database and a refresh to all listed Appendices

Hyperlinks (allowing the reader to access documents located on the internet and to maneuver within this document) are provided throughout this document and are identified with underlined text. When navigating within this document, return to the previously viewed page by pressing the “ALT” and “←” keys simultaneously.

Figures in this document are representations and are not to scale.

## **6. How are metrics represented?**

Throughout this AC, customary English units will be used followed with “soft” (rounded) conversion to metric units. The English units govern.

## **7. How can I get this and other FAA publications?**

You can view a list of all ACs at [http://www.faa.gov/regulations\\_policies/advisory\\_circulars/](http://www.faa.gov/regulations_policies/advisory_circulars/).  
You can view the Federal Aviation Regulations at  
[http://www.faa.gov/regulations\\_policies/faa\\_regulations/](http://www.faa.gov/regulations_policies/faa_regulations/).



**Michael J. O'Donnell**  
Director of Airport Safety and Standards

**TABLE OF CONTENTS**

**Chapter 1. Introduction..... 1**

101. Purpose..... 1

102. Definitions..... 2

103. Roles of Federal, State and Local governments..... 10

104. Airport operator responsibilities. .... 11

105. Planning. .... 12

106. Airport Layout Plan (ALP). .... 15

107. Collection, processing and publication of airport data. .... 15

108. Related Advisory Circulars (ACs), Orders, and Federal regulations..... 17

109. to 199. Reserved..... 30

**Chapter 2. Design Process ..... 31**

201. General..... 31

202. Design aircraft..... 33

203. Runway incursions..... 34

204. Airport design standards and the environmental process. .... 34

205. Planned visibility minimums for instrument procedures..... 35

206. Airport Traffic Control Tower (ATCT) siting..... 36

207. Airport Reference Point (ARP)..... 37

208. Heliports/helipads. .... 37

209. Other aeronautical uses on airports..... 37

210. Drainage considerations..... 37

211. Security of airports..... 39

212. Pavement strength and design..... 40

213. Location of on-airfield facilities. .... 41

214. to 299. Reserved..... 41

**Chapter 3. Runway Design..... 43**

301. Introduction..... 43

302. Runway design concepts..... 43

303. Runway end siting requirements..... 46

304. Runway geometry..... 54

305. Runway line of sight requirements. .... 57

306. Object clearing..... 58

307. Runway Safety Area (RSA) / Engineered Materials Arresting Systems (EMAS).  
..... 59

308. Obstacle Free Zone (OFZ)..... 62

309. Runway Object Free Area (ROFA)..... 69

310. Runway Protection Zone (RPZ)..... 71

311. Clearway standards..... 76

312. Stopway standards..... 77

	313.	Surface gradient.....	77
	314.	Turf runways.....	82
	315.	Marking and lighting.....	85
	316.	Parallel runway separation requirements.....	86
	317.	Approach procedures.....	87
	318.	Aircraft Rescue and Fire Fighting (ARFF) access.....	91
	319.	Jet blast.....	91
	320.	Runway design requirements matrix.....	92
	321.	On-airport farming.....	92
	322.	Declared distances.....	96
	323.	Approach and Departure Reference Codes.....	111
	324.	to 399. Reserved.....	113
	<b>Chapter 4.</b>	<b>Taxiway and Taxilane Design.....</b>	<b>115</b>
	401.	General.....	115
	402.	Taxiway definitions.....	121
	403.	Taxiway/taxilane width.....	122
	404.	Taxiway/taxilane clearance requirements.....	122
	405.	Parallel taxiways.....	129
	406.	Curves and intersections.....	131
	407.	Runway/taxiway intersections.....	140
	408.	Entrance taxiways.....	140
	409.	Exit taxiways.....	143
	410.	Bypass taxiways.....	148
	411.	Crossover taxiways.....	149
	412.	Holding bays for runway ends.....	152
	413.	Taxiway turnarounds.....	155
	414.	Apron taxiways and taxilanes.....	155
	415.	End-Around Taxiways (EAT).....	156
	416.	Aligned taxiways prohibited.....	159
	417.	Taxiway shoulders.....	159
	418.	Surface gradient and Line Of Sight (LOS).....	161
	419.	Markings/lighting/signs.....	162
	420.	Islands.....	162
	421.	Taxiway bridges.....	162
	422.	Jet blast.....	163
	423.	to 499. Reserved.....	163
	<b>Chapter 5.</b>	<b>Aprons.....</b>	<b>165</b>
	501.	Background.....	165
	502.	Apron types.....	165
	503.	Apron layout and runway incursion prevention.....	165
	504.	Apron design.....	166
	505.	Fueling.....	168
	506.	Object clearance.....	169

507. Deicing facilities..... 169  
 508. Surface gradients..... 169  
 509. Drainage..... 169  
 510. Marking and lighting..... 169  
 511. Pavement design. .... 170  
 512. Jet blast..... 170  
 513. Airport Traffic Control Tower (ATCT) visibility / Line Of Sight (LOS). .... 170  
 514. Apron service roads. .... 170  
 515. to 599. Reserved..... 171

**Chapter 6. Navigation Aids (NAVAIDs) and On-airport Air Traffic Control Facilities (ATC-F)..... 173**

601. Background..... 173  
 602. Introduction and purpose..... 173  
 603. Federally owned and non-federally owned NAVAIDs. .... 175  
 604. Siting criteria/land requirements..... 175  
 605. NAVAIDs as obstacles..... 176  
 606. Physical security..... 178  
 607. Maintenance access..... 181  
 608. Electrical power..... 181  
 609. Cable protection..... 181  
 610. Cable loop system..... 181  
 611. Communication and power cable trenches..... 181  
 612. Facilities..... 182  
 613. Towers and elevated structures..... 182  
 614. Air Traffic Organization (ATO) – Orders and Notices..... 182  
 615. Decommissioned facilities..... 182  
 616. Airport Traffic Control Tower (ATCT)..... 183  
 617. Remote Transmitter/Receiver (RTR) and Remote Communications Outlet (RCO).  
 ..... 184  
 618. Airport Surveillance Radar (ASR)..... 184  
 619. Precision Runway Monitor (PRM)..... 185  
 620. Airport Surface Detection Equipment (ASDE)..... 186  
 621. Approach Lighting System (ALS)..... 186  
 622. Approach Lead-In Lighting System (LDIN)..... 193  
 623. Runway End Identifier Lighting (REIL)..... 194  
 624. Airport rotating beacons..... 196  
 625. Precision Approach Path Indicator (PAPI)..... 196  
 626. Instrument Landing System (ILS)..... 198  
 627. Distance Measuring Equipment (DME)..... 201  
 628. Runway Visual Range (RVR)..... 202  
 629. Very High Frequency Omnidirectional Range (VOR)..... 203  
 630. Non-Directional Beacon (NDB)..... 206  
 631. Segmented circles and wind cones..... 206  
 632. Automated Surface Observing System (ASOS) and Automated Weather  
 Observing System (AWOS)..... 207

633.	Weather Camera (WCAM).....	207
634.	Wind Equipment F-400 (WEF). ....	208
635.	Low Level Windshear Alert System (LLWAS). ....	209
636.	Runway Status Lights (RWSL). ....	209
637.	to 699. Reserved.....	209
<b>Chapter 7.</b>	<b>Airfield Bridges and Tunnels.....</b>	<b>211</b>
701.	General.....	211
702.	Siting guidelines.....	213
703.	Dimensional criteria.....	214
704.	Load considerations. ....	214
705.	Marking and lighting.....	215
706.	Other considerations. ....	215
707.	Storm water structures. ....	218
708.	to 799. Reserved.....	218
<b>Appendix 1.</b>	<b>Aircraft Characteristics.....</b>	<b>219</b>
A1-1.	Basic aircraft characteristics. ....	219
A1-2.	Background. ....	221
A1-3.	Aircraft arranged by aircraft manufacturer, and Runway Design Code (RDC). ....	221
<b>Appendix 2.</b>	<b>Wind Analysis.....</b>	<b>231</b>
A2-1.	Objective.....	231
A2-2.	Crosswinds.....	232
A2-3.	Allowable crosswind components. ....	232
A2-4.	Coverage and orientation of runways. ....	232
A2-5.	Assembling wind data.....	232
A2-6.	Data source.....	233
A2-7.	Analyzing wind data. ....	236
A2-8.	Conclusions.....	239
A2-9.	Assumptions.....	239
A2-10.	Automated wind analysis tools. ....	239
<b>Appendix 3.</b>	<b>The Effects and Treatment of Jet Blast .....</b>	<b>241</b>
A3-1.	Introduction.....	241
A3-2.	Jet blast effects.....	241
A3-3.	Jet engine exhaust velocity and temperature. ....	241
A3-4.	Blast fences.....	242
A3-5.	Shoulders and blast pads.....	242
A3-6.	Aircraft parking layout and jet blast effect(s).....	243
<b>Appendix 4.</b>	<b>End-Around Taxiway (EAT) Screens .....</b>	<b>247</b>
A4-1.	Screen sizing.....	247



A4-2.	Screen construction.....	248
<b>Appendix 5. General Aviation Aprons and Hangars .....</b>		<b>257</b>
A5-1.	Background.....	257
A5-2.	General aviation apron.....	257
A5-3.	Wash pads.....	258
A5-4.	Fueling.....	258
A5-5.	Object clearance.....	258
A5-6.	Surface gradients.....	258
A5-7.	Drainage.....	260
A5-8.	Marking and lighting.....	260
A5-9.	Hangars.....	260
<b>Appendix 6. Compass Calibration Pad .....</b>		<b>263</b>
A6-1.	Purpose.....	263
A6-2.	Background.....	263
A6-3.	Design of compass calibration pad.....	263
A6-4.	Location of compass calibration pad.....	266
A6-5.	Construction of compass calibration pad.....	267
<b>Appendix 7. Runway Design Standards Matrix .....</b>		<b>269</b>
<b>Appendix 8. Taxiway Fillet Design .....</b>		<b>283</b>
A8-1.	Description.....	283
A8-2.	Dimensions.....	283
A8-3.	Transitions.....	284
<b>Appendix 9. Acronyms .....</b>		<b>295</b>
<b>Appendix 10. Index.....</b>		<b>301</b>
<b>Record of Changes .....</b>		<b>305</b>

**LIST OF FIGURES**

Figure 1-1.	Taxiway Design Groups (TDGs).....	15
Figure 3-1.	Runway ends.....	46
Figure 3-2.	Threshold siting based on approach slope.....	49
Figure 3-3.	Approach slopes – with offset approach course.....	51
Figure 3-4.	Departure surface for instrument runways (40:1).....	53
Figure 3-5.	Runway Safety Area (RSA).....	55
Figure 3-6.	Intersecting runways.....	56
Figure 3-7.	Runway visibility zone.....	58

Figure 3-8. Percent of aircraft overrun versus distance beyond the runway end.....	60
Figure 3-9. Obstacle Free Zone (OFZ) for visual runways and runways with not lower than 3/4 statute mile (1.2 km) approach visibility minimums .....	63
Figure 3-10. OFZ for operations on runways by small aircraft with lower than 3/4 statute mile (1.2 km) approach visibility minimums.....	64
Figure 3-11. OFZ for operations on runways by large aircraft with lower than 3/4 statute mile (1.2 km) approach visibility minimums.....	64
Figure 3-12. OFZ for operations on runways by large aircraft with lower than 3/4 statute mile (1.2 km) approach visibility minimums and displaced threshold .....	65
Figure 3-13. Sectional views of the OFZ.....	66
Figure 3-14. Precision Obstacle Free Zone (POFZ) – no displaced threshold .....	68
Figure 3-15. POFZ – displaced threshold .....	70
Figure 3-16. Runway Protection Zone (RPZ), Runway Object Free Area (ROFA) and Runway Safety Area (RSA) .....	72
Figure 3-17. Runway with all declared distances equal to the runway length .....	74
Figure 3-18. Approach and departure RPZs where the Takeoff Run Available (TORA) is less than the Takeoff Distance Available (TODA).....	75
Figure 3-19. Clearway .....	76
Figure 3-20. Stopway.....	78
Figure 3-21. Longitudinal grade limitations for aircraft approach categories A and B.....	79
Figure 3-22. Longitudinal grade limitations for aircraft approach categories C, D, and E .....	81
Figure 3-23. Transverse grade limitations .....	83
Figure 3-24. RSA grade limitations beyond 200 feet (61 m) from the runway end .....	84
Figure 3-25. Parallel runway separation, simultaneous radar controlled approach – staggered threshold.....	88
Figure 3-26. Typical airport layout.....	95
Figure 3-27. Location of start of Accelerate-Stop Distance Available (ASDA), TODA, and TORA.....	98
Figure 3-28. Normal location of departure end of TORA .....	99
Figure 3-29. Departure end of TORA based on departure RPZ located to mitigate unacceptable incompatible land use .....	99
Figure 3-30. TODA shortened to mitigate penetration to the departure surface resulting in shortened TORA .....	100
Figure 3-31. TODA extended by use of a clearway, shortened TORA .....	101
Figure 3-32. Normal location of departure end of TODA (no clearway).....	102
Figure 3-33. TODA extended by use of a clearway, normal TORA .....	103
Figure 3-34. Normal location of stop end of ASDA and Landing Distance Available (LDA) ...	104
Figure 3-35. Stop end of ASDA and LDA located to provide additional RSA.....	105
Figure 3-36. Stop end of ASDA and LDA located to provide additional Runway Object Free Area (ROFA) .....	106
Figure 3-37. Stop end of ASDA located based on use of a stopway .....	107
Figure 3-38. Normal start of LDA .....	108
Figure 3-39. Start of LDA at displaced threshold based on Threshold Siting Surface (TSS) .....	109
Figure 3-40. Start of LDA at displaced threshold based on approach RPZ located to mitigate unacceptable incompatible land use.....	109
Figure 3-41. Start of LDA at displaced threshold located to provide additional RSA .....	110

Figure 3-42. Start of LDA at displaced threshold located to provide additional ROFA .....	111
Figure 4-1. Three-node taxiway intersection .....	116
Figure 4-2. Not recommended taxiway design .....	118
Figure 4-3. Proper taxiway design .....	118
Figure 4-4. Taxiway designs that are not recommended (examples a, b, c, d).....	119
Figure 4-5. Taxiway designs that are not recommended (examples e, f, g) .....	120
Figure 4-6. Taxiway Edge Safety Margin (TESM) on straight segment.....	121
Figure 4-7. Wingtip clearance - parallel taxiways .....	123
Figure 4-8. Wingtip clearance from taxiway .....	125
Figure 4-9. Wingtip clearance from taxilane .....	126
Figure 4-10. Wingtip clearance from apron taxiway .....	127
Figure 4-11. TSA and TOFA at taxiway intersections .....	128
Figure 4-12. Parallel taxiways .....	130
Figure 4-13. Taxiway turn - 90 degree delta.....	133
Figure 4-14. Taxiway turn - less than 90 degree delta.....	134
Figure 4-15. Taxiway turn - greater than 90 degree delta.....	134
Figure 4-16. Key MGW-CMG combinations for modeling aircraft movements .....	139
Figure 4-17. Entrance taxiway .....	141
Figure 4-18. High speed exit for TDG-5 .....	144
Figure 4-19. Right-angled exit taxiway .....	145
Figure 4-20. Poor design of high speed exits.....	146
Figure 4-21. Proper design of high speed exits.....	147
Figure 4-22. Bypass taxiway.....	148
Figure 4-23. Crossover taxiway where direction reversal is needed based on TDG.....	150
Figure 4-24. Crossover taxiway where direction reversal is necessary based on ADG .....	150
Figure 4-25. Crossover taxiway without direction reversal between taxiways .....	152
Figure 4-26. Typical holding bay configuration.....	153
Figure 4-27. Holding bay – not recommended design.....	154
Figure 4-28. Poor holding bay design.....	154
Figure 4-29. Taxiway turnaround .....	155
Figure 4-30. End-Around Taxiway (EAT) – ADG-II.....	157
Figure 4-31. EAT – ADG-III .....	158
Figure 4-32. Aligned taxiway .....	160
Figure 4-33. Taxiway transverse gradients.....	162
Figure 6-1. Typical Communications, Navigation, Surveillance and Weather (CNSW).....	174
Figure 6-2. Two frangible connections .....	178
Figure 6-3. Airport Traffic Control Tower (ATCT) facility.....	183
Figure 6-4. Remote Transmitter/Receiver (RTR) communication facility.....	184
Figure 6-5. Airport Surveillance Radar (ASR) steel tower (17 feet [5 m] high) .....	185
Figure 6-6. Precision Runway Monitor (PRM) facility .....	186
Figure 6-7. Approach Lighting System (ALS) with Sequenced Flashers II (ALSF-2) .....	188
Figure 6-8. Simplified Short Approach Light System with Runway Alignment (SSALR) .....	189
Figure 6-9. Medium Intensity Approach Lighting System (MALS) with Runway Alignment Indicator Lights (MALSR) .....	190
Figure 6-10. MALSR facility.....	191
Figure 6-11. MALS.....	191

Figure 6-12. MALS with Sequenced Flashers (MALSF).....	192
Figure 6-13. Omnidirectional Airport Lighting System (ODALS).....	192
Figure 6-14. Lead-in Lighting System (LDIN).....	193
Figure 6-15. Approach LDIN facility.....	194
Figure 6-16. Runway End Identifier Lighting (REIL).....	195
Figure 6-17. REIL.....	195
Figure 6-18. Precision Approach Path Indicator (PAPI).....	197
Figure 6-19. PAPI light boxes.....	197
Figure 6-20. Instrument Landing System (ILS) Localizer (LOC) siting and critical area.....	198
Figure 6-21. LOC 8-antenna array.....	199
Figure 6-22. LOC 14-antenna array.....	200
Figure 6-23. Glideslope (GS) siting and critical area.....	200
Figure 6-24. GS antenna and equipment shelter.....	201
Figure 6-25. Distance Measuring Equipment (DME) antenna.....	201
Figure 6-26. Touchdown Runway Visual Range (RVR).....	202
Figure 6-27. Enroute VHF Omnidirectional Range (VOR) facility.....	204
Figure 6-28. Terminal VOR (TVOR) facility.....	204
Figure 6-29. TVOR installation.....	205
Figure 6-30. TVOR clearances.....	205
Figure 6-31. Non-Directional Beacon (NDB) facility.....	206
Figure 6-32. Segmented circle and wind cone.....	206
Figure 6-33. Automated Surface Observing System (ASOS) weather sensors suite.....	207
Figure 6-34. Weather Camera (WCAM) pole.....	208
Figure 6-35. Weather equipment sensor pole.....	208
Figure 6-36. Low Level Windshear Alert System (LLWAS) sensor pole.....	209
Figure 7-1. Tunnel under a runway and parallel taxiway.....	211
Figure 7-2. Cross-section of a tunnel under a runway and taxiway.....	212
Figure 7-3. Airfield bridge.....	213
Figure 7-4. Shoulder markings for taxiway bridges.....	216
Figure 7-5. Example of a structural deck with lighted depressed roadway.....	217
Figure A1-1. Typical dimensions of large aircraft.....	219
Figure A1-2. Typical dimensions of small aircraft.....	220
Figure A2-1. Wind vector diagram.....	231
Figure A2-2. Blank windrose showing direction and divisions.....	234
Figure A2-3. Completed windrose using Figure A2-1 data.....	235
Figure A2-4. Windrose analysis.....	238
Figure A4-1. End-Around Taxiway (EAT) screen horizontal geometry.....	247
Figure A4-2. Visual screen width calculation.....	248
Figure A4-3. EAT screen vertical dimension calculation.....	249
Figure A4-4. Stop end of the runway/EAT elevation difference.....	249
Figure A4-5. Examples of mounting screen to vertical column.....	250
Figure A4-6. Examples of panel layout for 13-foot (4 m) high screen.....	252
Figure A4-7. Diagonal stripe orientation.....	253
Figure A5-1. Tiedown layouts.....	259
Figure A6-1. Compass calibration pad marking layout.....	264
Figure A6-2. Typical compass calibration pad.....	265

Figure A8-1. Filet design example.....	283
Figure A8-2. Angle of intersection (delta).....	285
Figure A8-3. Steering angle of no more than 50 degrees .....	286
Figure A8-4. Track of the main gear is modeled, offset by the TESM .....	287
Figure A8-5. Minimize excess pavement while providing the required TESM.....	288
Figure A8-6. Pavement edge (main gear track + TESM) offset by 6 inches (15 cm) .....	289
Figure A8-7. Detail of Figure A8-6 .....	290
Figure A8-8. Tapers selected to minimize excess pavement while considering constructability.....	291
Figure A8-9. Radius of outer pavement edge determined based on the minimum CMG and maximum MGW in the TDG.....	292
Figure A8-10. Dimensions applied to the design.....	293

### LIST OF TABLES

Table 1-1. Aircraft Approach Category (AAC).....	13
Table 1-2. Airplane Design Group (ADG) .....	14
Table 1-3. Visibility minimums.....	14
Table 2-1. Changes in airport design standards associated with an upgrade in the first two components (Aircraft Approach Category [AAC] and Airplane Design Group [ADG]) of the Runway Design Code (RDC).....	32
Table 2-2. Changes in airport design standards associated with lowering the third component (approach visibility minimums) of the Runway Design Code (RDC).....	33
Table 2-3. Aircraft characteristics and design components .....	34
Table 3-1. Allowable crosswind component per Runway Design Code (RDC) .....	44
Table 3-2. Approach/departure standards table .....	50
Table 3-3. Transverse grades .....	69
Table 3-4. Standards for Instrument Approach Procedures.....	90
Table 3-5. Runway design standards matrix.....	93
Table 3-6. Runway to taxiway separation for reverse turns from a high-speed exit based on Taxiway Design Group (TDG).....	94
Table 3-7. Approach Reference Code (APRC).....	112
Table 3-8. Departure Reference Code (DPRC) .....	113
Table 4-1. Design standards based on Airplane Design Group (ADG).....	124
Table 4-2. Design standards based on Taxiway Design Group (TDG) .....	124
Table 4-3. Standard intersection details for TDG 1A.....	135
Table 4-4. Standard intersection details for TDG 1B .....	135
Table 4-5. Standard intersection details for TDG 2.....	136
Table 4-6. Standard intersection details for TDG 3.....	136
Table 4-7. Standard intersection details for TDG 4.....	137
Table 4-8. Standard intersection details for TDG 5.....	137
Table 4-9. Standard intersection details for TDG 6.....	138
Table 4-10. Standard intersection details for TDG 7.....	138
Table 4-11. MGW-CMG combinations.....	139
Table 4-12. Dimensions for runway entrance/exit taxiways (where the two 90-degree turns are nonstandard).....	142
Table 4-13. Exit taxiway cumulative utilization percentages.....	147

Table 4-14. Crossover taxiways with direction reversal between taxiways based on TDG.....	149
Table 4-15. Crossover taxiways with direction reversal between taxiways based on ADG .....	151
Table 6-1. Fixed-by-function designation for NAVAID and Air Traffic Control (ATC) facilities for Runway Safety Area (RSA) and Runway Object Free Area (ROFA) .....	177
Table 6-2. List of NAVAID facility type.....	179
Table 6-3. Surveillance facility type.....	180
Table 6-4. Communications facility type.....	180
Table 6-5. Weather detection facility type.....	180
Table A1-1. Aircraft characteristics database – sorted by aircraft manufacturer/model .....	221
Table A2-1. Standard wind analysis results for ALL_WEATHER.....	237
Table A4-1. Aircraft characteristics.....	249
Table A4-2. International Committee of Illumination (CIE) chromaticity coordinate limits.....	253
Table A4-3. Minimum coefficient of retroreflection candelas/foot candle/square foot/candelas/lux/square meter .....	254
Table A4-4. Visual screen panel wind loads .....	254
Table A7-1. Runway design standards matrix, A/B-I Small Aircraft.....	269
Table A7-2. Runway design standards matrix, A/B - I.....	270
Table A7-3. Runway design standards matrix, A/B – II Small Aircraft.....	271
Table A7-4. Runway design standards matrix, A/B – II.....	272
Table A7-5. Runway design standards matrix, A/B - III.....	273
Table A7-6. Runway design standards matrix, A/B - IV.....	274
Table A7-7. Runway design standards matrix, C/D/E - I.....	275
Table A7-8. Runway design standards matrix, C/D/E - II.....	276
Table A7-9. Runway design standards matrix, C/D/E - III .....	277
Table A7-10. Runway design standards matrix, C/D/E - IV .....	278
Table A7-11. Runway design standards matrix, C/D/E - V .....	279
Table A7-12. Runway design standards matrix, C/D/E - VI.....	280

## Chapter 1. Introduction

### 101. Purpose.

**a. General.** Title 49 United States Code (USC), Chapter 401, General Provisions, Section (§) 40101(d) states in part, “[T]he [FAA] Administrator shall consider the following matters, among others, as being in the public interest: (1) assigning, maintaining, and enhancing safety and security as the highest priorities in air commerce, (2) regulating air commerce in a way that best promotes safety and fulfills national defense requirements, (3) encouraging and developing civil aeronautics, including new aviation technology.” This public charge, in effect, requires the development and maintenance of a national system of safe, delay-free, and cost-effective airports. The use of the standards and recommendations contained in this publication in the design of airports supports this public charge. In addition, Title 49 USC Chapter 471, Airport Development, § 47101, states that “[i]t is the policy of the United States that the safe operation of the airport and airway system is the highest aviation priority.” The policy emphasizes, in part, airport construction and improvement projects that:

- (1) Increase safety
- (2) Increase capacity to accommodate passenger and cargo and decrease delays
- (3) Comply with federal environmental standards (see also Order 5050.4, National Environmental Policy Act [NEPA] Implementing Instructions for Airport Projects).
- (4) Encourage innovative technologies that promote safety, capacity, and efficiency.

The use of the standards and recommendations contained in this advisory circular (AC) support this policy.

These standards and recommendations, however, do not limit or regulate the operations of aircraft.

**b. New airports.** These standards and recommendations represent the most effective national approach for meeting the long-term aviation demand in a manner that is consistent with national policy. Safety is the highest priority. The airport design standards in this AC are intended to identify the design elements needed to maintain safety and efficiency according to national policy.

**c. Existing airports.** Every effort should be made to bring an airport up to current standards. It may not, however, be feasible to meet all current standards at existing airports, and in the case of federal assistance programs, funding of improvements may be subject to FAA criteria. In those cases, consultation with the appropriate offices of the FAA Office of Airports and Flight Standards Service will identify any applicable FAA funding criteria and/or adjustments to operational procedures necessary to accommodate operations to the maximum extent while maintaining an acceptable level of safety. For non-standard conditions associated

with such projects, the FAA may consider alternative means of ensuring an acceptable level of safety. For further information regarding a modification of standards, refer to Order 5300.1, Modification to Agency Airport Design, Construction, and Equipment Standards.

**d. Federal regulations and safety.**

(1) Aircraft operations cannot be prevented, regulated, or controlled simply because the airport or runway does not meet the design standards for a particular aircraft type. For specific operational situations unique to the airport, consult with the FAA Flight Standards Service.

(2) Airports that have scheduled air carrier operations with more than nine passenger seats or unscheduled air carrier operations with more than 30 passenger seats are regulated by Title 14 Code of Federal Regulations (CFR) Part 139, Certification of Airports. Compliance with this AC may be used to demonstrate compliance with specific requirements of Part 139.

**e. Design standards.** The selection of the design aircraft, or group of aircraft characteristics, used to design or update an airport facility is a planning decision, beyond the scope of this AC. Thus, this AC does not consider such factors as:

(1) Airport ownership.

(2) Funding source used to establish, improve, or update the facility to meet anticipated needs.

(3) Service level designation in the National Plan of Integrated Airport Systems (NPIAS).

For additional information on the eligibility for federal funding, please refer to Order 5100.38, Airport Improvement Program Handbook.

**102. Definitions.**

The definitions in this paragraph are relevant to airport design standards.

**a.** *Accelerate-Stop Distance Available (ASDA).* See Declared Distances.

**b.** *Air Traffic Control Facilities (ATC-F).* Electronic equipment and buildings aiding air traffic control (ATC) – for communications, surveillance of aircraft including weather detection and advisory systems.

**c.** *Aircraft.* For this AC, the terms aircraft and airplane are synonymous, referring to all types of fixed-wing airplanes, including gliders. Powered lift (tilt-rotors) and helicopters are not included except where specifically noted.

**d.** *Aircraft Approach Category (AAC).* As specified in 14 CFR Part 97 § 97.3, Symbols and Terms Used in Procedures, a grouping of aircraft based on a reference landing



speed ( $V_{REF}$ ), if specified, or if  $V_{REF}$  is not specified, 1.3 times stall speed ( $V_{SO}$ ) at the maximum certificated landing weight.  $V_{REF}$ ,  $V_{SO}$ , and the maximum certificated landing weight are those values as established for the aircraft by the certification authority of the country of registry.

**e.** *Airplane.* A fixed-wing aircraft that is heavier than air, and is supported in flight by the dynamic reaction of the air against its wings (see Aircraft).

**f.** *Airplane Design Group (ADG).* A classification of aircraft based on wingspan and tail height. When the aircraft wingspan and tail height fall in different groups, the higher group is used.

**g.** *Airport Elevation.* The highest point on an airport's usable runways expressed in feet above mean sea level (MSL).

**h.** *Airport Layout Plan (ALP).* A scaled drawing (or set of drawings), in either traditional or electronic form, of current and future airport facilities that provides a graphic representation of the existing and long-term development plan for the airport and demonstrates the preservation and continuity of safety, utility, and efficiency of the airport to the satisfaction of the FAA.

**i.** *Airport Reference Code (ARC).* An airport designation that signifies the airport's highest Runway Design Code (RDC), minus the third (visibility) component of the RDC. The ARC is used for planning and design only and does not limit the aircraft that may be able to operate safely on the airport.

**j.** *Airport Reference Point (ARP).* The approximate geometric center of all usable runways at the airport.

**k.** *Airport.* An area of land that is used or intended to be used for the landing and takeoff of aircraft, and includes its buildings and facilities, if any.

**l.** *Aligned Taxiway.* A taxiway with its centerline aligned with a runway centerline. Sometimes referred to as an "inline taxiway."

**m.** *Approach Procedure with Vertical Guidance (APV).* An Instrument Approach Procedure (IAP) providing both vertical and lateral electronic guidance.

**n.** *Approach Reference Code (APRC).* A code signifying the current operational capabilities of a runway and associated parallel taxiway with regard to landing operations.

**o.** *Approach Surface Baseline (ASBL).* A horizontal line tangent to the surface of the earth at the runway threshold aligned with the final approach course.

**p.** *Blast Fence.* A barrier used to divert or dissipate jet blast or propeller wash.

**q.** *Blast Pad.* A surface adjacent to the ends of runways provided to reduce the erosive effect of jet blast and propeller wash. A blast pad is not a stopway.

**r.** *Building Restriction Line (BRL).* A line that identifies suitable and unsuitable locations for buildings on airports.

**s.** *Bypass Taxiway.* A taxiway used to reduce aircraft queuing demand by providing multiple takeoff points.

**t.** *Category-I (CAT-I).* An instrument approach or approach and landing with a Height Above Threshold (HATh) or minimum descent altitude not lower than 200 ft (60 m) and with either a visibility not less than ½ statute mile (800m), or a runway visual range not less than 1800 ft (550m).

**u.** *Category-II (CAT-II).* An instrument approach or approach and landing with a Height Above Threshold (HATh) lower than 200 ft (60 m) but not lower than 100 ft (30 m) and a runway visual range not less than 1200 ft (350m).

**v.** *Category-III (CAT-III).* An instrument approach or approach and landing with a Height Above Threshold (HATh) lower than 100 ft (30m), or no HATh, or a runway visual range less than 1200 ft (350m).

**w.** *Circling Approach.* A maneuver initiated by the pilot to align the aircraft with a runway for landing when a straight-in landing from an instrument approach is not possible or is not desirable.

**x.** *Clearway (CWY).* A defined rectangular area beyond the end of a runway cleared or suitable for use in lieu of runway to satisfy takeoff distance requirements (see also Takeoff Distance Available [TODA]).

**y.** *Cockpit to Main Gear Distance (CMG).* The distance from the pilot's eye to the main gear turn center.

**z.** *Compass Calibration Pad.* An airport facility used for calibrating an aircraft compass.

**aa.** *Crossover Taxiway.* A taxiway connecting two parallel taxiways (also referred to as a transverse taxiway).

**bb.** *Decision Altitude (DA).* A specified altitude on a vertically-guided approach at which a missed approach must be initiated if the required visual reference to continue the approach has not been established. DA is referenced to mean sea level (MSL).

**cc.** *Declared Distances.* The distances the airport owner declares available for a turbine powered aircraft's takeoff run, takeoff distance, accelerate-stop distance, and landing distance requirements. The distances are:

**(1)** *Takeoff Run Available (TORA)* – the runway length declared available and suitable for the ground run of an aircraft taking off;

(2) *Takeoff Distance Available (TODA)* – the TORA plus the length of any remaining runway or clearway beyond the far end of the TORA; the full length of TODA may need to be reduced because of obstacles in the departure area;

(3) *Accelerate-Stop Distance Available (ASDA)* – the runway plus stopway length declared available and suitable for the acceleration and deceleration of an aircraft aborting a takeoff; and

(4) *Landing Distance Available (LDA)* – the runway length declared available and suitable for landing an aircraft.

**dd.** *Departure End of Runway (DER)*. The end of the runway that is opposite the landing threshold. It is sometimes referred to as the stop end of runway.

**ee.** *Departure Reference Code (DPRC)*. A code signifying the current operational capabilities of a runway with regard to takeoff operations.

**ff.** *Design Aircraft*. An aircraft with characteristics that determine the application of airport design standards for a specific runway, taxiway, taxilane, apron, or other facility (such as Engineered Materials Arresting System [EMAS]). This aircraft can be a specific aircraft model or a composite of several aircraft using, expected, or intended to use the airport or part of the airport. (Also called “critical aircraft” or “critical design aircraft.”)

**gg.** *Displaced Threshold*. A threshold that is located at a point on the runway beyond the beginning of the runway.

**hh.** *End-Around Taxiway (EAT)*. A taxiway crossing the extended centerline of a runway, which does not require specific clearance from air traffic control (ATC) to cross the extended centerline of the runway.

**ii.** *Entrance Taxiway*. A taxiway designed to be used by an aircraft entering a runway. Entrance taxiways may also be used to exit a runway.

**jj.** *Exit Taxiway*. A taxiway designed to be used by an aircraft only to exit a runway:

(1) *Acute-Angled Exit Taxiway* – A taxiway forming an angle less than 90 degrees from the runway centerline.

(2) *High Speed Exit Taxiway* – An acute-angled exit taxiway forming a 30 degree angle with the runway centerline, designed to allow an aircraft to exit a runway without having to decelerate to typical taxi speed.

**kk.** *Fixed-By-Function Navigation Aid (NAVAID)*. An air navigation aid that must be positioned in a particular location in order to provide an essential benefit for aviation is fixed-by-function. Table 6-1 gives fixed-by-function designations for various NAVAIDs as they relate to the Runway Safety Area (RSA) and Runway Object Free Area (ROFA). Some NAVAIDs that are not fixed-by-function in regard to the RSA or ROFA may be fixed-by-function in regard to the Runway Protection Zone (RPZ):

(1) Equipment shelters, junction boxes, transformers, and other appurtenances that support a fixed-by-function NAVAID are not fixed-by-function in regard to the RSA or ROFA unless operational requirements require them to be located near the NAVAID.

(2) Some NAVAIDs, such as localizers (LOCs), can provide beneficial performance even when they are not located at their optimal location. These NAVAIDs are not fixed-by-function in regard to the RSA or ROFA.

**ll.** *Frangible.* Retains its structural integrity and stiffness up to a designated maximum load, but on impact from a greater load, breaks, distorts, or yields in such a manner as to present the minimum hazard to aircraft. See AC 150/5220-23, Frangible Connections.

**mm.** *General Aviation.* All non-scheduled flights other than military conducted by non-commercial aircraft. General aviation covers local recreational flying to business transport that is not operating under the FAA regulations for commercial air carriers.

**nn.** *Glide Path Angle (GPA).* The GPA is the angle of the final approach descent path relative to the approach surface baseline.

**oo.** *Glide Path Qualification Surface (GQS).* An imaginary surface extending from the runway threshold along the runway centerline extended to the Decision Altitude (DA) point.

**pp.** *Glideslope (GS).* Equipment in an Instrument Landing System (ILS) that provides vertical guidance to landing aircraft.

**qq.** *Hazard to Air Navigation.* An existing or proposed object that the FAA, as a result of an aeronautical study, determines will have a substantial adverse effect upon the safe and efficient use of navigable airspace by aircraft, operation of air navigation facilities, or existing or potential airport capacity.

**rr.** *Height Above Airport (HAA).* The height of the circling approach descent altitude (MDA) above the airport elevation.

**ss.** *Height Above Threshold (HATH).* The height of the Decision Altitude (DA) or Minimum Descent Altitude (MDA) above the threshold.

**tt.** *Hot Spot.* A location on an airport movement area with a history of potential risk of collision or runway incursion, and where heightened attention by pilots and drivers is necessary.

**uu.** *Instrument Approach Procedure (IAP).* A series of predetermined maneuvers for the orderly transfer of an aircraft under instrument flight conditions from the beginning of the initial approach to a landing or to a point from which a landing may be made visually. It is prescribed and approved for a specific airport by competent authority.

**vv.** *Instrument departure runway.* A runway identified by the airport operator, through the appropriate FAA Airports Office, to the FAA Regional Airspace Procedures Team intended primarily for instrument departures.

**ww.** *Island.* An unused paved or grassy area between taxiways, between runways, or between a taxiway and a runway. Paved islands are clearly marked as unusable, either by painting or the use of artificial turf.

**xx.** *Joint-Use Airport.* An airport owned by the United States that leases a portion of the airport to a person operating an airport specified under Part 139.

**yy.** *Landing Distance Available (LDA).* See Declared Distances.

**zz.** *Large Aircraft.* An aircraft with a maximum certificated takeoff weight of more than 12,500 lbs (5670 kg).

**aaa.** *Low Impact Resistant (LIR) Support.* A support designed to resist operational and environmental static loads and fail when subjected to a shock load such as that from a colliding aircraft.

**bbb.** *Main Gear Width (MGW).* The distance from the outer edge to outer edge of the widest set of main gear tires.

**ccc.** *Minimum Descent Altitude (MDA).* The lowest authorized altitude on an approach that does not have vertical guidance. MDA is referenced to mean sea level (MSL).

**ddd.** *Modification to Standards.* Any approved nonconformance to FAA standards, other than dimensional standards for Runway Safety Areas (RSAs), applicable to an airport design, construction, or equipment procurement project that is necessary to accommodate an unusual local condition for a specific project on a case-by-case basis while maintaining an acceptable level of safety. See Order 5300.1.

**eee.** *Movement Area.* The runways, taxiways, and other areas of an airport that are used for taxiing or hover taxiing, air taxiing, takeoff, and landing of aircraft including helicopters and tilt-rotors, exclusive of loading aprons and aircraft parking areas (reference Part 139).

**fff.** *Navigation Aid (NAVAID).* Electronic and visual air navigation aids, lights, signs, and associated supporting equipment.

**ggg.** *Non-movement area.* The areas of an airport that are used for taxiing or hover taxiing, or air taxiing aircraft including helicopters and tilt-rotors, but are not part of the movement area (i.e., the loading aprons and aircraft parking areas).

**hhh.** *Non-Precision Approach (NPA).* For the purposes of this AC, a straight-in instrument approach procedure that provides course guidance, with or without vertical path guidance, with visibility minimums not lower than 3/4 mile (4000 RVR).

**iii.** *Non-Precision Runway.* A runway (other than a precision runway) with at least one end having a non-precision approach procedure.

**jjj.** *Object.* Includes, but is not limited to, above ground structures, Navigational Aids (NAVAIDs), equipment, vehicles, natural growth, terrain, and parked or taxiing aircraft.

**kkk.** *Object Free Area (OFA).* An area centered on the ground on a runway, taxiway, or taxilane centerline provided to enhance the safety of aircraft operations by remaining clear of objects, except for objects that need to be located in the OFA for air navigation or aircraft ground maneuvering purposes.

**lll.** *Obstacle.* An existing object at a fixed geographical location or which may be expected at a fixed location within a prescribed area with reference to which vertical clearance is or must be provided during flight operation.

**mmm.** *Obstacle Clearance Surface (OCS).* An evaluation surface that defines the minimum required obstruction clearance for approach or departure procedures.

**nnn.** *Obstacle Free Zone (OFZ).* The OFZ is the three-dimensional airspace along the runway and extended runway centerline that is required to be clear of obstacles for protection for aircraft landing or taking off from the runway and for missed approaches.

**ooo.** *Obstruction to Air Navigation.* An object of greater height than any of the heights or surfaces presented in Subpart C of Title 14 CFR Part 77, Standards for Determining Obstructions to Air Navigation or Navigational Aids or Facilities.

**ppp.** *Parallel Taxiway.* A taxiway parallel to a runway:

(1) *Dual Parallel Taxiways* – Two side-by-side taxiways, parallel to each other and the runway.

(2) *Full Parallel Taxiway* – A parallel taxiway extending the full length of the runway.

(3) *Partial Parallel Taxiway* – A parallel taxiway extending less than full length of the runway.

**qqq.** *Precision Approach (PA).* For the purposes of this AC, an instrument approach procedure that provides course and vertical path guidance with visibility below 3/4 mile (4000 RVR).

**rrr.** *Precision Runway.* A runway with at least one end having a precision approach procedure.

**sss.** *Runway (RW).* A defined rectangular surface on an airport prepared or suitable for the landing or takeoff of aircraft.

**ttt.** *Runway Design Code (RDC).* A code signifying the design standards to which the runway is to be built.

**uuu.** *Runway Incursion.* Any occurrence at an airport involving the incorrect presence of an aircraft, vehicle or person on the protected area of a surface designated for the landing and takeoff of aircraft.

**vvv.** *Runway Protection Zone (RPZ).* An area at ground level prior to the threshold or beyond the runway end to enhance the safety and protection of people and property on the ground.

**www.** *Runway Safety Area (RSA).* A defined surface surrounding the runway prepared or suitable for reducing the risk of damage to aircraft in the event of an undershoot, overshoot, or excursion from the runway.

**xxx.** *Shoulder.* An area adjacent to the defined edge of paved runways, taxiways, or aprons providing a transition between the pavement and the adjacent surface; support for aircraft and emergency vehicles deviating from the full-strength pavement; enhanced drainage; and blast protection.

**yyy.** *Small Aircraft.* An aircraft with a maximum certificated takeoff weight of 12,500 lbs (5670 kg) or less.

**zzz.** *Stopway (SWY).* An area beyond the takeoff runway, no less wide than the runway and centered upon the extended centerline of the runway, able to support the airplane during an aborted takeoff, without causing structural damage to the airplane, and designated by the airport authorities for use in decelerating the airplane during an aborted takeoff. A blast pad is not a stopway.

**aaaa.** *Takeoff Distance Available (TODA).* See Declared Distances.

**bbbb.** *Takeoff Run Available (TORA).* See Declared Distances.

**cccc.** *Taxilane (TL).* A taxiway designed for low speed and precise taxiing. Taxilanes are usually, but not always, located outside the movement area, providing access from taxiways (usually an apron taxiway) to aircraft parking positions and other terminal areas.

**dddd.** *Taxiway (TW).* A defined path established for the taxiing of aircraft from one part of an airport to another.

**eeee.** *Taxiway Design Group (TDG).* A classification of airplanes based on outer to outer Main Gear Width (MGW) and Cockpit to Main Gear distance (CMG).

**ffff.** *Taxiway Edge Safety Margin (TESM).* The distance between the outer edge of the landing gear of an airplane with its nose gear on the taxiway centerline and the edge of the taxiway pavement.

**gggg.** *Taxiway/Taxilane Safety Area (TSA).* A defined surface alongside the taxiway prepared or suitable for reducing the risk of damage to an aircraft deviating from the taxiway.

**hhhh.** *Threshold (TH).* The beginning of that portion of the runway available for landing. In some instances, the threshold may be displaced. "Threshold" always refers to landing, not the start of takeoff.

**iii.** *Threshold Crossing Height (TCH).* For the purposes of this AC, the TCH is the theoretical height above the runway threshold at which the aircraft's glideslope (GS) antenna would be if the aircraft maintains the trajectory established by the Instrument Landing System (ILS) GS, or the height of the pilot's eye above the runway threshold based on a visual guidance system.

**jjjj.** *Visual Runway.* A runway without an existing or planned instrument approach procedure.

**kkkk.** *Wingspan.* The maximum horizontal distance from one wingtip to the other wingtip, including the horizontal component of any extensions such as winglets or raked wingtips.

### **103. Roles of Federal, State and Local governments.**

#### **a. Federal.**

**(1)** Federal Assistance. The FAA administers a grant program (Order 5100.38) which provides financial assistance for developing public-use airports. Persons interested in the program can obtain information from the FAA Airports Regional Office or Airports District Office (ADO) that serves their geographic area. Consult these offices for assistance with selection of the design aircraft for federally funded projects, which depends on demand factors that are beyond the scope of this AC. Technical assistance with airport development is also available from these offices.

**(2)** Obligated Airports. Airport sponsors agree to certain obligations when they accept Federal grant funds or Federal property transfers for airport purposes. The duration of these obligations depends on the type, the recipient, the useful life of the facility being developed, and other conditions stipulated. The FAA enforces these obligations through its Airport Compliance Program. More information on the Airport Compliance Program can be found in Order 5190.6, FAA Airport Compliance Manual. Information on specific assurances and obligations associated with Federal grant funds can be found in Order 5100.38. The standards in this AC demonstrate compliance with obligations associated with airport design and development.

**(3)** Certificated Airports. The FAA regulates commercial service airports under Part 139. This regulation prescribes rules governing the certification and operation of airports in any State of the United States, the District of Columbia, or any territory or possession of the United States that serve scheduled or unscheduled passenger service. ACs contain methods and procedures that certificate holders may use to comply with the requirements of Part 139.

**(4)** Non-Obligated Public-Use and Private-Use Airports. For airports not included in subparagraphs (2) and (3) above:

(a) The standards in this AC are recommended for all civil airports.

(b) Proponents must comply with Part 157, Notice of Construction, Alteration, Activation, and Deactivation of Airports. See paragraph 104.



(5) **Environmental Protection.** Federal assistance in airport development projects and ALP approvals require the FAA to follow the procedures of the NEPA in connection with project approval. NEPA requires the FAA to disclose to the interested public a clear, accurate description of potential environmental impacts and reasonable alternatives to the proposed action. Order 5050.4 provides guidance for meeting NEPA requirements. See also Order 1050.1, Policies and Procedures for Considering Environmental Impacts.

**b. State.** Design Standards. Although FAA can accept state standards for construction materials and methods under certain conditions (reference AC 150/5100-13, Development of State Standards for Nonprimary Airports), the use of state dimensional standards that differ from the standards in this AC are NOT acceptable for federally obligated or certificated airports.

**c. Local.** Many communities have zoning ordinances, building codes, and fire regulations that may affect airport development.

#### **104. Airport operator responsibilities.**

##### **a. Notice of proposed construction.**

(1) **Part 77.** Part 77 requires proponents of construction or alteration on or near airports to notify the FAA, allowing the FAA to evaluate the potential impact on air navigation. The FAA encourages filing the Notice electronically on the FAA's Obstruction Evaluation/Airport Airspace Analysis (OE/AAA) website: <https://oeaaa.faa.gov/oeaaa>.

(2) **Part 157.** Part 157 applies to persons proposing to construct, alter, activate, or deactivate a civil or joint-use airport or to alter the status or use of such an airport. Certain exceptions apply. Refer to Part 157 for additional information.

(3) **Plans on file.** Future airport development plans and feasibility studies on file with the FAA may influence the determination resulting from Part 77 studies. Having their plans on file with the FAA is the only way airport owners can ensure full consideration of airport development. For any new runway, runway extension, or planned runway upgrade, the necessary plan data include, as a minimum, planned runway end and threshold coordinates, elevation(s), type of instrument approach, visibility minimum(s) desired, and whether the runway will be a designated instrument departure runway. See paragraphs 107, 302 and 303. "Plan on file" data, in general, needs to be submitted by the airport owner with complete and sufficient information on the development. An update to the ALP is generally the best method to transmit plan on file information. Submit this information to the local FAA Airports Region or ADO that serves your geographic area. The location of Airports Region and ADO offices is available on the FAA website: [www.faa.gov/airports](http://www.faa.gov/airports), or the OE/AAA website: <https://oeaaa.faa.gov/oeaaa>.

(4) **Additional information.** Specific airspace procedures and requirements can be found in Order JO 7400.2, Procedures for Handling Airspace Matters, and AC 150/5200-35, Submitting the Airport Master Record in Order to Activate a New Airport, for additional guidance.

**b. Maintenance of obstacle clearance surfaces.** Federally obligated airports are subject to Grant Assurances 20 and 21 which require the protection of the approach and departure surfaces. Airports operating under Code of Federal Regulations (CFR) Part 139 are also subject to Part 139.331 to mitigate obstructions. The airport operator has an ongoing obligation to review the surface(s) for obstructions. The FAA reviews all Instrument Approach Procedures (IAP) on a periodic basis; approximately every two years. Obstacles found within the associated approach/departure surfaces at that time may result in higher minima, loss of approaches and/or loss of night operations.

## 105. Planning.

Airport planning should consider both the present and potential aviation needs and demand associated with the airport. Consider planning for runways and taxiways locations that will meet future separation requirements even if the width, strength, and length must increase later. Such decisions should be supported by appropriate planning and should be shown on the approved ALP. Coordination with the FAA and users of the airport will assist in determining the immediate and long range characteristics that will best satisfy the needs of the community and travelling public. In general, however, airport planning is beyond the scope of this AC. See AC 150/5020-1, Noise Control and Compatibility Planning for Airports, AC 150/5060-5, Airport Capacity and Delay, AC 150/5070-6, Airport Master Plans, and AC 150/5070-7, The Airport System Planning Process.

**a. Applicability of airport design standards.** Airport design standards provide basic guidelines for a safe, efficient, and economic airport system. The standards and recommendations in this AC cover the wide range of size and performance characteristics of aircraft that are anticipated to use an airport. These standards and recommendations also cover various elements of airport infrastructure and their functions. Airport designers and planners need to carefully choose the basic aircraft characteristics for which the airport will be designed. Airport designs based only on existing aircraft can severely limit the ability to expand the airport to meet future requirements for larger, more demanding aircraft. Airport designs that are based on large aircraft never likely to be served by the airport are not economical. Building to the standards in this AC ensures that aircraft in a particular category can operate at the airport without restrictions or location-specific encumbrances that could impact safe and efficient operations.

**b. Design aircraft.** Planning a new airport or improvements to an existing airport requires the selection of one or more “design aircraft.” In the case of a private airport, the design aircraft can take the form of one particular aircraft, and frequency of operations may not be a consideration. In most cases, however, the design aircraft for the purposes of airport geometric design is a composite aircraft representing a collection of aircraft classified by three parameters: Aircraft Approach Category (AAC), Airplane Design Group (ADG) and Taxiway Design Group (TDG). These parameters, explained in detail in paragraph 105.c, represent the aircraft that are intended to be accommodated by the airport. In the case of an airport with multiple runways, a design aircraft is selected for each runway. The first consideration of the airport planner should be the safe operation of aircraft likely to use the airport. Any operation of an aircraft that exceeds design criteria of the airport may result in either an unsafe operation or a lesser safety margin unless air traffic control (ATC) Standard Operating Procedures (SOPs) are in place for

those operations. However, it is not the usual practice to base the airport design on an aircraft that uses the airport infrequently, and it is appropriate and necessary to develop ATC SOPs to accommodate faster and/or larger aircraft that use the airport occasionally. See paragraph 103.a regarding the selection of a design aircraft for airport development projects using federal assistance programs. Any aspect of airport design indicated in this AC as being based on a family of airplanes that does not accommodate the entire AAC, ADG, or TDG is subject to FAA review.

**c. Runway Design Code (RDC).** The selected AAC, ADG, and approach visibility minimums are combined to form the RDC of a particular runway. The RDC provides the information needed to determine certain design standards that apply. The first component, depicted by a letter, is the AAC and relates to aircraft approach speed (operational characteristics) (see Table 1-1). The second component, depicted by a Roman numeral, is the ADG and relates to either the aircraft wingspan or tail height (physical characteristics); whichever is most restrictive, of the largest aircraft expected to operate on the runway and taxiways adjacent to the runway (see Table 1-2). The third component relates to the visibility minimums expressed by RVR values in feet of 1200, 1600, 2400, 4000, and 5000 (corresponding to lower than 1/4 mile, lower than 1/2 mile but not lower than 1/4 mile, lower than 3/4 mile but not lower than 1/2 mile, lower than 1 mile but not lower than 3/4 mile, and not lower than 1 mile, respectively) (see Table 1-3). The third component should read “VIS” for runways designed with visual approach use only. Generally, runway standards are related to aircraft approach speed, aircraft wingspan, and designated or planned approach visibility minimums. Runway to taxiway and taxiway/taxilane to taxiway/taxilane separation standards are related to ADG, TDG, and approach visibility minimums. For example, an airport’s air carrier runway can have an RDC of C-IV-1200. The same airport’s smaller runway used for general aviation activity can have an RDC of B-II-2400. (The design aircraft for other aspects of runway design, such as length and pavement strength, may be different. It will be based on other factors, such as haul length and maximum takeoff weight.) See Chapter 3 for guidance on runway design and separation requirements. See Chapter 4 for guidance on taxiway design.

**Table 1-1. Aircraft Approach Category (AAC)**

AAC	V <sub>REF</sub> /Approach Speed
A	Approach speed less than 91 knots
B	Approach speed 91 knots or more but less than 121 knots
C	Approach speed 121 knots or more but less than 141 knots
D	Approach speed 141 knots or more but less than 166 knots
E	Approach speed 166 knots or more

**Table 1-2. Airplane Design Group (ADG)**

Group #	Tail Height (ft [m])	Wingspan (ft [m])
<b>I</b>	< 20' (< 6 m)	< 49' (< 15 m)
<b>II</b>	20' - < 30' (6 m - < 9 m)	49' - < 79' (15 m - < 24 m)
<b>III</b>	30' - < 45' (9 m - < 13.5 m)	79' - < 118' (24 m - < 36 m)
<b>IV</b>	45' - < 60' (13.5 m - < 18.5 m)	118' - < 171' (36 m - < 52 m)
<b>V</b>	60' - < 66' (18.5 m - < 20 m)	171' - < 214' (52 m - < 65 m)
<b>VI</b>	66' - < 80' (20 m - < 24.5 m)	214' - < 262' (65 m - < 80 m)

**Table 1-3. Visibility minimums**

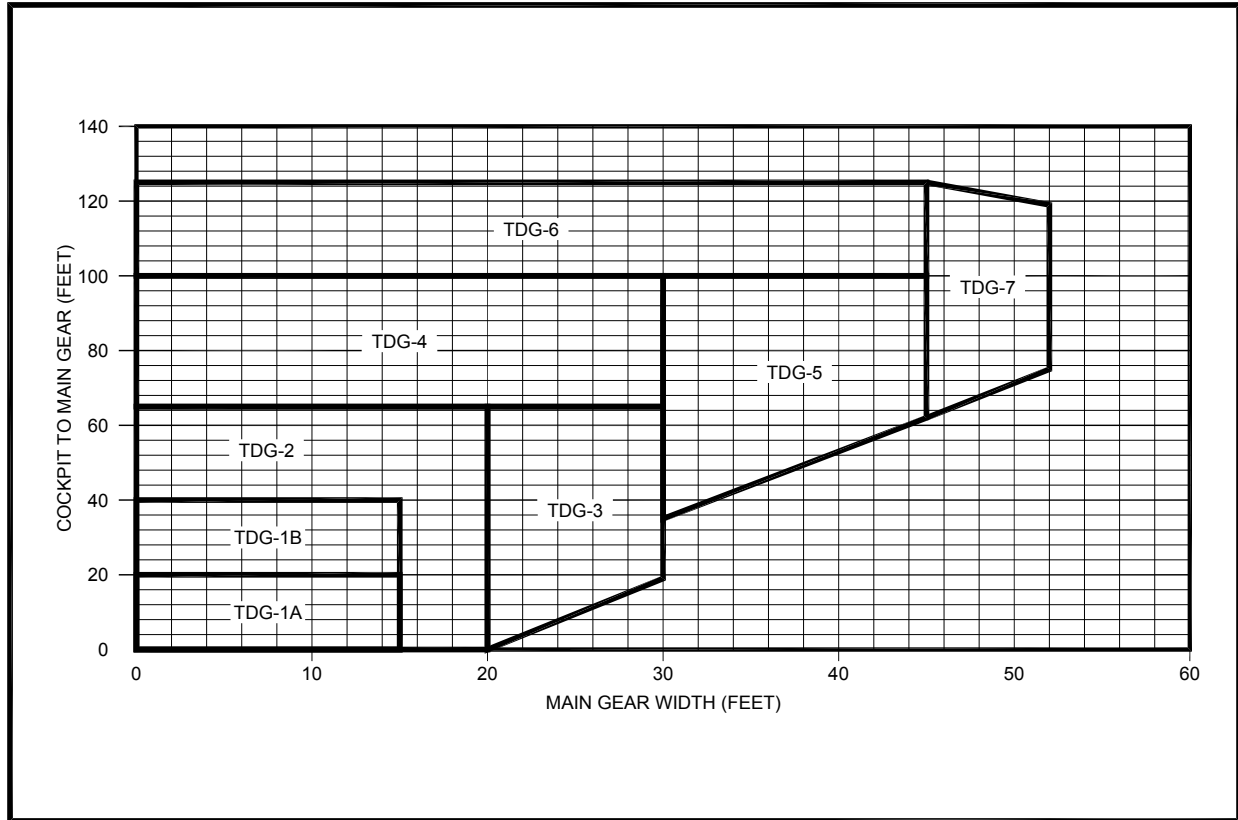
RVR (ft) *	Instrument Flight Visibility Category (statute mile)
<b>5000</b>	Not lower than 1 mile
<b>4000</b>	Lower than 1 mile but not lower than ¾ mile
<b>2400</b>	Lower than ¾ mile but not lower than ½ mile
<b>1600</b>	Lower than ½ mile but not lower than ¼ mile
<b>1200</b>	Lower than ¼ mile

\* RVR values are not exact equivalents.

**d. Taxiway Design Group (TDG).** TDG relates to the undercarriage dimensions of the aircraft. Taxiway/taxilane width and fillet standards, and in some instances, runway to taxiway and taxiway/taxilane separation requirements, are determined by TDG. It is appropriate for a series of taxiways on an airport to be built to a different TDG than another based on expected use. See [Figure 1-1](#).

**e. Approaches.** Based on current and anticipated demand, the airport should be planned for appropriate minimums and aircraft. Such planning includes the appropriate RPZ size and approach slopes for the future design aircraft and visibility minimums. Proper planning should ensure that future airspace requirements are adequately protected with an FAA plan on file (see paragraph [104.a\(3\)](#)). See paragraphs [306](#) and [302.d](#) for obstruction clearing standards.

**f. Land acquisition and airspace protection.** Off-airport development will have a negative impact on current and future airport operations when it creates obstacles to the safe and efficient use of the airspace surrounding the airport. Consider off-airport conditions and land acquisition needs when designing the ultimate airport configuration, including the number and orientation of runways and proper separation for parallel taxiways and the terminal building complex. Land acquisition to protect all possible airspace intrusions is generally not feasible, and is usually supplemented by local zoning, easements, or other means to mitigate potential incompatible land uses and potential obstacle conflicts. [AC 150/5190-4](#), A Model Zoning Ordinance to Limit Height of Objects around Airports, presents guidance for controlling the height of objects around airports. At a minimum for new runways, land acquisition should include Object Free Areas (OFAs) and Runway Protection Zones (RPZs). To the extent practicable, land acquisition should include adequate areas surrounding the runway(s) to protect the runway approach and departure surfaces identified in paragraph [303](#), and for existing and planned runways OFAs and RPZs.



**Figure 1-1. Taxiway Design Groups (TDGs)**

#### 106. Airport Layout Plan (ALP).

**a. Description.** An ALP is a scaled drawing (or set of drawings), in either traditional or electronic form, of existing and proposed land and facilities necessary for the operation and development of the airport. Any airport will benefit from a carefully developed plan that reflects current FAA design standards and planning criteria. AC 150/5070-6 contains guidance on the development of ALPs, as well as a detailed listing of the various components that constitute a well-appointed ALP.

**b. Federally obligated airports.** All airport development at federally obligated airports must conform to an FAA-approved ALP. The ALP should conform to the FAA airport design standards existing at the time of its approval. Due to unusual site, environmental, or other constraints, the FAA may approve an ALP not fully complying with design standards. Such approval requires the FAA to determine the proposed modification to standards is safe for the specific site and conditions. See Order 5300.1. When the FAA revises a standard, airport owners should incorporate the changes in the ALP and implement the new standards before all new development.

#### 107. Collection, processing and publication of airport data.

**a. Airport data needs.** Airport planning, design, and evaluation activities require information that accurately describes the location and condition of airport facilities as well as

off-airport structures and features. This information is derived from geospatial data that are collected during the planning, design, and construction phase of airport development. Geospatial data describe objects in a three-dimensional geographic reference system that relates physical objects with the surrounding airspace. It is crucial for airports to accurately collect and report safety-critical data to the FAA in a timely manner. AC 150/5300-18, General Guidance and Specifications for Submission of Aeronautical Surveys to NGS: Field Data Collection and Geographic Information System (GIS) Standards, provides standards for identifying, collecting, and reporting safety critical data. FAA uses these data, in part, to:

- (1) Protect existing runway approaches from proposed development that could create a hazard to air navigation,
- (2) Provide for the design and development of new IAPs to the lowest visibility minimums possible,
- (3) Provide accurate information for planning studies that assess the impact of airport noise, and
- (4) Ensure that review and coordination of on-airport development proposals maintain critical clearance standards for the completed project.

**b. Airspace data.** The FAA conducts airspace studies of proposed development under Part 77 as described in paragraph 104. These studies assess the potential impact on air navigation using the best available data and plans on file. To ensure that the FAA has the best possible data with which to conduct these studies, the airport should submit any airfield changes as soon as they occur. This process is usually done in connection with ALP updates, but airports are encouraged to keep the FAA up to date with critical changes any time they occur. In particular, ensure that FAA has the latest data on actual and planned facilities for:

- (1) Runway ends.
- (2) Displaced thresholds.
- (3) High and low points on the runway surfaces.
- (4) Helipads.

**c. Airport master record.** The FAA maintains airport master records that are used to publish safety and operational information in the Airport/Facility Directory (A/FD). This information is usually collected during periodic FAA-sponsored inspections of the airport. These inspections collect information on runway length, runway condition, runway strength, navigational facilities, and controlling obstructions as well as other important data. Inspections are conducted in connection with Part 139 certification inspections for commercial service airports and Airport Master Record inspection for all other airports. Airport operators should become aware of the inspection schedules for their airports and ensure that the inspectors are provided with the latest changes to insure that FAA publications are current and accurate.

**d. Aeronautical surveys.** The FAA uses aeronautical surveys to develop and modify instrument procedures. Survey requirements are provided by AC 150/5300-16, General Guidance and Specifications for Aeronautical Surveys: Establishment of Geodetic Control and Submission to the National Geodetic Survey, AC 150/5300-17, Standards for Using Remote Sensing Technologies in Airport Surveys, and AC 150/5300-18.

**e. Airports Geographic Information System (GIS).** The Airports GIS is a comprehensive geographic information system that will house critical safety data for the FAA and the airport community. Data in the Airports GIS will be collected by individual airports and validated by the FAA for use, in part, to:

- (1) Conduct airspace studies
- (2) Publish aeronautical information
- (3) Develop instrument flight procedures
- (4) Facilitate internal review and coordination of all airport development proposals.

Airports GIS information and data specifications can be found in AC 150/5300-18.

#### **108. Related Advisory Circulars (ACs), Orders, and Federal regulations.**

The following is a list of documents referenced in this AC and additional related information. Most Advisory Circulars, Orders, and Regulations can be found online at www.faa.gov. All references to ACs, Orders, and Federal Regulations are to be the most recent versions.

**a. Advisory Circulars (ACs).**

(1) AC 00-44, Status of Federal Aviation Regulations, [http://www.faa.gov/airports/resources/advisory\\_circulars/index.cfm/go/document.current/documentNumber/00-44](http://www.faa.gov/airports/resources/advisory_circulars/index.cfm/go/document.current/documentNumber/00-44).

(2) AC 20-35, Tiedown Sense, [http://www.faa.gov/airports/resources/advisory\\_circulars/index.cfm/go/document.current/documentNumber/20-35](http://www.faa.gov/airports/resources/advisory_circulars/index.cfm/go/document.current/documentNumber/20-35).

(3) AC 70/7460-1, Obstruction Marking and Lighting, [http://www.faa.gov/airports/resources/advisory\\_circulars/index.cfm/go/document.current/documentNumber/70\\_7460-1](http://www.faa.gov/airports/resources/advisory_circulars/index.cfm/go/document.current/documentNumber/70_7460-1).

(4) AC 103-6, Ultralight Vehicle Operations – Airports, ATC, and Weather, [http://www.faa.gov/airports/resources/advisory\\_circulars/index.cfm/go/document.current/documentNumber/103-6](http://www.faa.gov/airports/resources/advisory_circulars/index.cfm/go/document.current/documentNumber/103-6).

(5) AC 120-28, Criteria for Approval of Category III Weather Minima for Takeoff, Landing and Rollout, [http://www.faa.gov/airports/resources/advisory\\_circulars/index.cfm/go/document.current/documentNumber/120-28](http://www.faa.gov/airports/resources/advisory_circulars/index.cfm/go/document.current/documentNumber/120-28).

(6) AC 120-29, Criteria for Approval of Category I and Category II Weather Minimums for Approach, [http://www.faa.gov/airports/resources/advisory\\_circulars/index.cfm/go/document.current/documentNumber/120-29](http://www.faa.gov/airports/resources/advisory_circulars/index.cfm/go/document.current/documentNumber/120-29).

(7) AC 120-57, Surface Movement Guidance and Control System, [http://www.faa.gov/airports/resources/advisory\\_circulars/index.cfm/go/document.current/documentNumber/120-57](http://www.faa.gov/airports/resources/advisory_circulars/index.cfm/go/document.current/documentNumber/120-57).

(8) AC 150/5020-1, Noise Control and Compatibility Planning for Airports, [http://www.faa.gov/airports/resources/advisory\\_circulars/index.cfm/go/document.current/documentNumber/150\\_5020-1](http://www.faa.gov/airports/resources/advisory_circulars/index.cfm/go/document.current/documentNumber/150_5020-1).

(9) AC 150/5060-5, Airport Capacity and Delay, [http://www.faa.gov/airports/resources/advisory\\_circulars/index.cfm/go/document.current/documentNumber/150\\_5060-5](http://www.faa.gov/airports/resources/advisory_circulars/index.cfm/go/document.current/documentNumber/150_5060-5).

(10) AC 150/5070-6, Airport Master Plans, [http://www.faa.gov/airports/resources/advisory\\_circulars/index.cfm/go/document.current/documentNumber/150\\_5070-6](http://www.faa.gov/airports/resources/advisory_circulars/index.cfm/go/document.current/documentNumber/150_5070-6).

(11) AC 150/5070-7, The Airport System Planning Process, [http://www.faa.gov/airports/resources/advisory\\_circulars/index.cfm/go/document.current/documentNumber/150\\_5070-7](http://www.faa.gov/airports/resources/advisory_circulars/index.cfm/go/document.current/documentNumber/150_5070-7).

(12) AC 150/5100-13, Development of State Standards for Nonprimary Airports, [http://www.faa.gov/airports/resources/advisory\\_circulars/index.cfm/go/document.current/documentNumber/150\\_5100-13](http://www.faa.gov/airports/resources/advisory_circulars/index.cfm/go/document.current/documentNumber/150_5100-13).

(13) AC 150/5100-17, Land Acquisition and Relocation Assistance for Airport Improvement Program Assisted Projects, [http://www.faa.gov/airports/resources/advisory\\_circulars/index.cfm/go/document.current/documentNumber/150\\_5100-17](http://www.faa.gov/airports/resources/advisory_circulars/index.cfm/go/document.current/documentNumber/150_5100-17).

(14) AC 150/5190-4, A Model Zoning Ordinance to Limit Height of Objects around Airports, [http://www.faa.gov/airports/resources/advisory\\_circulars/index.cfm/go/document.current/documentNumber/150\\_5190-4](http://www.faa.gov/airports/resources/advisory_circulars/index.cfm/go/document.current/documentNumber/150_5190-4).

(15) AC 150/5190-6, Exclusive Rights at Federally Obligated Airports, [http://www.faa.gov/airports/resources/advisory\\_circulars/index.cfm/go/document.current/documentNumber/150\\_5190-6](http://www.faa.gov/airports/resources/advisory_circulars/index.cfm/go/document.current/documentNumber/150_5190-6).



**(16)** AC 150/5190-7, Minimum Standards for Commercial Aeronautical Activities, [http://www.faa.gov/airports/resources/advisory\\_circulars/index.cfm/go/document.current/documentNumber/150\\_5190-7](http://www.faa.gov/airports/resources/advisory_circulars/index.cfm/go/document.current/documentNumber/150_5190-7).

**(17)** AC 150/5200-33, Hazardous Wildlife Attractants On or Near Airports, [http://www.faa.gov/airports/resources/advisory\\_circulars/index.cfm/go/document.current/documentNumber/150\\_5200-33](http://www.faa.gov/airports/resources/advisory_circulars/index.cfm/go/document.current/documentNumber/150_5200-33).

**(18)** AC 150/5200-34, Construction or Establishment of Landfills near Public Airports, [http://www.faa.gov/airports/resources/advisory\\_circulars/index.cfm/go/document.current/documentNumber/150\\_5200-34](http://www.faa.gov/airports/resources/advisory_circulars/index.cfm/go/document.current/documentNumber/150_5200-34).

**(19)** AC 150/5200-35, Submitting the Airport Master Record in Order to Activate a New Airport, [http://www.faa.gov/airports/resources/advisory\\_circulars/index.cfm/go/document.current/documentNumber/150\\_5200-35](http://www.faa.gov/airports/resources/advisory_circulars/index.cfm/go/document.current/documentNumber/150_5200-35).

**(20)** AC 150/5210-15, Aircraft Rescue and Firefighting Station Building Design, [http://www.faa.gov/airports/resources/advisory\\_circulars/index.cfm/go/document.current/documentNumber/150\\_5210-15](http://www.faa.gov/airports/resources/advisory_circulars/index.cfm/go/document.current/documentNumber/150_5210-15).

**(21)** AC 150/5210-22, Airport Certification Manual (ACM), [http://www.faa.gov/airports/resources/advisory\\_circulars/index.cfm/go/document.current/documentNumber/150\\_5210-22](http://www.faa.gov/airports/resources/advisory_circulars/index.cfm/go/document.current/documentNumber/150_5210-22).

**(22)** AC 150/5220-16, Automated Weather Observing Systems (AWOS) for Non-Federal Applications, [http://www.faa.gov/airports/resources/advisory\\_circulars/index.cfm/go/document.current/documentNumber/150\\_5220-16](http://www.faa.gov/airports/resources/advisory_circulars/index.cfm/go/document.current/documentNumber/150_5220-16).

**(23)** AC 150/5220-18, Buildings for Storage and Maintenance of Airport Snow and Ice Control Equipment and Materials, [http://www.faa.gov/airports/resources/advisory\\_circulars/index.cfm/go/document.current/documentNumber/150\\_5220-18](http://www.faa.gov/airports/resources/advisory_circulars/index.cfm/go/document.current/documentNumber/150_5220-18).

**(24)** AC 150/5220-22, Engineered Materials Arresting Systems (EMAS) for Aircraft Overruns, [http://www.faa.gov/airports/resources/advisory\\_circulars/index.cfm/go/document.current/documentNumber/150\\_5220-22](http://www.faa.gov/airports/resources/advisory_circulars/index.cfm/go/document.current/documentNumber/150_5220-22).

**(25)** AC 150/5220-23, Frangible Connections, [http://www.faa.gov/airports/resources/advisory\\_circulars/index.cfm/go/document.current/documentNumber/150\\_5220-23](http://www.faa.gov/airports/resources/advisory_circulars/index.cfm/go/document.current/documentNumber/150_5220-23).

**(26)** AC 150/5220-26, Airport Ground Vehicle Automatic Dependent Surveillance - Broadcast (ADS-B) Out Squitter Equipment, [http://www.faa.gov/airports/resources/advisory\\_circulars/index.cfm/go/document.current/documentNumber/150\\_5220-26](http://www.faa.gov/airports/resources/advisory_circulars/index.cfm/go/document.current/documentNumber/150_5220-26).

(27) AC 150/5230-4, Aircraft Fuel Storage, Handling, and Dispensing on Airports, [http://www.faa.gov/airports/resources/advisory\\_circulars/index.cfm/go/document.current/documentNumber/150\\_5230-4](http://www.faa.gov/airports/resources/advisory_circulars/index.cfm/go/document.current/documentNumber/150_5230-4).

(28) AC 150/5300-7, FAA Policy on Facility Relocations Occasioned by Airport Improvements or Changes, [http://www.faa.gov/airports/resources/advisory\\_circulars/index.cfm/go/document.current/documentNumber/150\\_5300-7](http://www.faa.gov/airports/resources/advisory_circulars/index.cfm/go/document.current/documentNumber/150_5300-7).

(29) AC 150/5300-14, Design of Aircraft Deicing Facilities, [http://www.faa.gov/airports/resources/advisory\\_circulars/index.cfm/go/document.current/documentNumber/150\\_5300-14](http://www.faa.gov/airports/resources/advisory_circulars/index.cfm/go/document.current/documentNumber/150_5300-14).

(30) AC 150/5300-16, General Guidance and Specifications for Aeronautical Surveys: Establishment of Geodetic Control and Submission to the National Geodetic Survey, [http://www.faa.gov/airports/resources/advisory\\_circulars/index.cfm/go/document.current/documentNumber/150\\_5300-16](http://www.faa.gov/airports/resources/advisory_circulars/index.cfm/go/document.current/documentNumber/150_5300-16).

(31) AC 150/5300-17, Standards for Using Remote Sensing Technologies in Airport Surveys, [http://www.faa.gov/airports/resources/advisory\\_circulars/index.cfm/go/document.current/documentNumber/150\\_5300-17](http://www.faa.gov/airports/resources/advisory_circulars/index.cfm/go/document.current/documentNumber/150_5300-17).

(32) AC 150/5300-18, General Guidance and Specifications for Submission of Aeronautical Surveys to NGS: Field Data Collection and Geographic Information System (GIS) Standards, [http://www.faa.gov/airports/resources/advisory\\_circulars/index.cfm/go/document.current/documentNumber/150\\_5300-18](http://www.faa.gov/airports/resources/advisory_circulars/index.cfm/go/document.current/documentNumber/150_5300-18).

(33) AC 150/5320-5 (UFC 3-230-01), Surface Drainage Design, [http://www.faa.gov/airports/resources/advisory\\_circulars/index.cfm/go/document.current/documentNumber/150\\_5320-5](http://www.faa.gov/airports/resources/advisory_circulars/index.cfm/go/document.current/documentNumber/150_5320-5).

(34) AC 150/5320-6, Airport Pavement Design and Evaluation, [http://www.faa.gov/airports/resources/advisory\\_circulars/index.cfm/go/document.current/documentNumber/150\\_5320-6](http://www.faa.gov/airports/resources/advisory_circulars/index.cfm/go/document.current/documentNumber/150_5320-6).

(35) AC 150/5320-12, Measurement, Construction, and Maintenance of Skid Resistant Airport Pavement Surfaces, [http://www.faa.gov/airports/resources/advisory\\_circulars/index.cfm/go/document.current/documentNumber/150\\_5320-12](http://www.faa.gov/airports/resources/advisory_circulars/index.cfm/go/document.current/documentNumber/150_5320-12).

(36) AC 150/5320-15, Management of Airport Industrial Waste, [http://www.faa.gov/airports/resources/advisory\\_circulars/index.cfm/go/document.current/documentNumber/150\\_5320-15](http://www.faa.gov/airports/resources/advisory_circulars/index.cfm/go/document.current/documentNumber/150_5320-15).

(37) AC 150/5325-4, Runway Length Requirements for Airport Design, [http://www.faa.gov/airports/resources/advisory\\_circulars/index.cfm/go/document.current/documentNumber/150\\_5325-4](http://www.faa.gov/airports/resources/advisory_circulars/index.cfm/go/document.current/documentNumber/150_5325-4).

(38) AC 150/5335-5, Standardized Method of Reporting Airport Pavement Strength – PCN, [http://www.faa.gov/airports/resources/advisory\\_circulars/index.cfm/go/document.current/documentNumber/150\\_5335-5](http://www.faa.gov/airports/resources/advisory_circulars/index.cfm/go/document.current/documentNumber/150_5335-5).

(39) AC 150/5340 and 150/5345 series, [http://www.faa.gov/regulations\\_policies/advisory\\_circulars/index.cfm/go/document.list/parentTopicID/63](http://www.faa.gov/regulations_policies/advisory_circulars/index.cfm/go/document.list/parentTopicID/63).

(40) AC 150/5340-1, Standards for Airport Markings, [http://www.faa.gov/airports/resources/advisory\\_circulars/index.cfm/go/document.current/documentNumber/150\\_5340-1](http://www.faa.gov/airports/resources/advisory_circulars/index.cfm/go/document.current/documentNumber/150_5340-1).

(41) AC 150/5340-5, Segmented Circle Airport Marker System, [http://www.faa.gov/airports/resources/advisory\\_circulars/index.cfm/go/document.current/documentNumber/150\\_5340-5](http://www.faa.gov/airports/resources/advisory_circulars/index.cfm/go/document.current/documentNumber/150_5340-5).

(42) AC 150/5340-18, Standards for Airport Sign Systems, [http://www.faa.gov/airports/resources/advisory\\_circulars/index.cfm/go/document.current/documentNumber/150\\_5340-18](http://www.faa.gov/airports/resources/advisory_circulars/index.cfm/go/document.current/documentNumber/150_5340-18).

(43) AC 150/5340-30, Design and Installation Details for Airport Visual Aids, [http://www.faa.gov/airports/resources/advisory\\_circulars/index.cfm/go/document.current/documentNumber/150\\_5340-30](http://www.faa.gov/airports/resources/advisory_circulars/index.cfm/go/document.current/documentNumber/150_5340-30).

(44) AC 150/5345-43, Specification for Obstruction Lighting Equipment, [http://www.faa.gov/airports/resources/advisory\\_circulars/index.cfm/go/document.current/documentNumber/150\\_5345-43](http://www.faa.gov/airports/resources/advisory_circulars/index.cfm/go/document.current/documentNumber/150_5345-43).

(45) AC 150/5345-44, Specification for Runway and Taxiway Signs, [http://www.faa.gov/airports/resources/advisory\\_circulars/index.cfm/go/document.current/documentNumber/150\\_5345-44](http://www.faa.gov/airports/resources/advisory_circulars/index.cfm/go/document.current/documentNumber/150_5345-44).

(46) AC 150/5345-52, Generic Visual Glideslope Indicators (GVGI), [http://www.faa.gov/airports/resources/advisory\\_circulars/index.cfm/go/document.current/documentNumber/150\\_5345-52](http://www.faa.gov/airports/resources/advisory_circulars/index.cfm/go/document.current/documentNumber/150_5345-52).

(47) AC 150/5360-9, Planning and Design of Airport Terminal Facilities at Non-Hub Locations, [http://www.faa.gov/airports/resources/advisory\\_circulars/index.cfm/go/document.current/documentNumber/150\\_5360-9](http://www.faa.gov/airports/resources/advisory_circulars/index.cfm/go/document.current/documentNumber/150_5360-9).

(48) AC 150/5360-13, Planning and Design Guidelines for Airport Terminal Facilities, [http://www.faa.gov/airports/resources/advisory\\_circulars/index.cfm/go/document.current/documentNumber/150\\_5360-13](http://www.faa.gov/airports/resources/advisory_circulars/index.cfm/go/document.current/documentNumber/150_5360-13).

(49) AC 150/5370-2, Operational Safety on Airports during Construction, [http://www.faa.gov/airports/resources/advisory\\_circulars/index.cfm/go/document.current/documentNumber/150\\_5370-2](http://www.faa.gov/airports/resources/advisory_circulars/index.cfm/go/document.current/documentNumber/150_5370-2).

(50) AC 150/5370-10, Standards for Specifying Construction of Airports, [http://www.faa.gov/airports/resources/advisory\\_circulars/index.cfm/go/document.current/documentNumber/150\\_5370-10](http://www.faa.gov/airports/resources/advisory_circulars/index.cfm/go/document.current/documentNumber/150_5370-10).

(51) AC 150/5370-15, Airside Applications for Artificial Turf, [http://www.faa.gov/airports/resources/advisory\\_circulars/index.cfm/go/document.current/documentNumber/150\\_5370-15](http://www.faa.gov/airports/resources/advisory_circulars/index.cfm/go/document.current/documentNumber/150_5370-15).

(52) AC 150/5390-2, Heliport Design, [http://www.faa.gov/airports/resources/advisory\\_circulars/index.cfm/go/document.current/documentNumber/150\\_5390-2](http://www.faa.gov/airports/resources/advisory_circulars/index.cfm/go/document.current/documentNumber/150_5390-2).

(53) AC 150/5395-1, Seaplane Bases, [http://www.faa.gov/airports/resources/advisory\\_circulars/index.cfm/go/document.current/documentNumber/150\\_5395-1](http://www.faa.gov/airports/resources/advisory_circulars/index.cfm/go/document.current/documentNumber/150_5395-1).

**b. Engineering Briefs.** Engineering Briefs cover various subjects, and supplement Advisory Circulars. Engineering Briefs are available at: [http://www.faa.gov/airports/engineering/engineering\\_briefs/](http://www.faa.gov/airports/engineering/engineering_briefs/).

**c. Orders.**

(1) Order 1050.1, Policies and Procedures for Considering Environmental Impacts, [http://www.faa.gov/regulations\\_policies/orders\\_notices/index.cfm/go/document.current/documentNumber/1050.1](http://www.faa.gov/regulations_policies/orders_notices/index.cfm/go/document.current/documentNumber/1050.1).

(2) Order 5050.4, National Environmental Policy Act (NEPA) Implementing Instructions for Airport Projects, [http://www.faa.gov/regulations\\_policies/orders\\_notices/index.cfm/go/document.current/documentNumber/5050.4](http://www.faa.gov/regulations_policies/orders_notices/index.cfm/go/document.current/documentNumber/5050.4).

(3) Order 5090.3, Field Formulation of the National Plan of Integrated Airport Systems (NPIAS), [http://www.faa.gov/regulations\\_policies/orders\\_notices/index.cfm/go/document.current/documentNumber/5090.3](http://www.faa.gov/regulations_policies/orders_notices/index.cfm/go/document.current/documentNumber/5090.3).

(4) Order 5100.37, Land Acquisition and Relocation Assistance for Airport Projects, [http://www.faa.gov/regulations\\_policies/orders\\_notices/index.cfm/go/document.current/documentNumber/5100.37](http://www.faa.gov/regulations_policies/orders_notices/index.cfm/go/document.current/documentNumber/5100.37).

(5) Order 5100.38, Airport Improvement Program Handbook, [http://www.faa.gov/regulations\\_policies/orders\\_notices/index.cfm/go/document.current/documentNumber/5100.38](http://www.faa.gov/regulations_policies/orders_notices/index.cfm/go/document.current/documentNumber/5100.38).

(6) Order 5190.6, FAA Airport Compliance Manual, [http://www.faa.gov/regulations\\_policies/orders\\_notices/index.cfm/go/document.current/documentNumber/5190.6](http://www.faa.gov/regulations_policies/orders_notices/index.cfm/go/document.current/documentNumber/5190.6).

(7) Order 5200.8, Runway Safety Area Program, [http://www.faa.gov/regulations\\_policies/orders\\_notices/index.cfm/go/document.current/documentNumber/5200.8](http://www.faa.gov/regulations_policies/orders_notices/index.cfm/go/document.current/documentNumber/5200.8).

(8) Order 5200.9, Financial Feasibility and Equivalency of Runway Safety Area Improvements and Engineered Material Arresting Systems, [http://www.faa.gov/regulations\\_policies/orders\\_notices/index.cfm/go/document.current/documentNumber/5200.9](http://www.faa.gov/regulations_policies/orders_notices/index.cfm/go/document.current/documentNumber/5200.9).

(9) Order 5200.11, FAA Airports (ARP) Safety Management System (SMS), [http://www.faa.gov/regulations\\_policies/orders\\_notices/index.cfm/go/document.current/documentNumber/5200.11](http://www.faa.gov/regulations_policies/orders_notices/index.cfm/go/document.current/documentNumber/5200.11).

(10) Order 5300.1, Modifications to Agency Airport Design, Construction, and Equipment Standards, [http://www.faa.gov/regulations\\_policies/orders\\_notices/index.cfm/go/document.current/documentNumber/5300.1](http://www.faa.gov/regulations_policies/orders_notices/index.cfm/go/document.current/documentNumber/5300.1).

(11) Order 6030.20, Electrical Power Policy, [http://www.faa.gov/regulations\\_policies/orders\\_notices/index.cfm/go/document.current/documentNumber/6030.20](http://www.faa.gov/regulations_policies/orders_notices/index.cfm/go/document.current/documentNumber/6030.20).

(12) Order 6310.6, Primary/secondary Terminal Radar Siting Handbook, [http://www.faa.gov/regulations\\_policies/orders\\_notices/index.cfm/go/document.current/documentNumber/6310.6](http://www.faa.gov/regulations_policies/orders_notices/index.cfm/go/document.current/documentNumber/6310.6).

(13) Order 6480.4, Airport Traffic Control Tower Siting Criteria, [http://www.faa.gov/regulations\\_policies/orders\\_notices/index.cfm/go/document.current/documentNumber/6480.4](http://www.faa.gov/regulations_policies/orders_notices/index.cfm/go/document.current/documentNumber/6480.4).

(14) Order 6560.10, Runway Visual Range (RVR), [http://www.faa.gov/regulations\\_policies/orders\\_notices/index.cfm/go/document.current/documentNumber/6560.10](http://www.faa.gov/regulations_policies/orders_notices/index.cfm/go/document.current/documentNumber/6560.10).

(15) Order 6560.20, Siting Criteria for Automated Weather Observing Systems (AWOS), [http://www.faa.gov/regulations\\_policies/orders\\_notices/index.cfm/go/document.current/documentNumber/6560.20](http://www.faa.gov/regulations_policies/orders_notices/index.cfm/go/document.current/documentNumber/6560.20).

(16) Order 6560.21, Siting Guidelines for Low Level Windshear Alert System (LLWAS) Remote Facilities, [http://www.faa.gov/regulations\\_policies/orders\\_notices/index.cfm/go/document.current/documentNumber/6560.21](http://www.faa.gov/regulations_policies/orders_notices/index.cfm/go/document.current/documentNumber/6560.21).

- (17) Order JO 6580.3, Remote Communications Facilities Installation Standards Handbook, [http://www.faa.gov/regulations\\_policies/orders\\_notices/index.cfm/go/document.current/documentNumber/6580.3](http://www.faa.gov/regulations_policies/orders_notices/index.cfm/go/document.current/documentNumber/6580.3).
- (18) Order 6750.16, Siting Criteria for Instrument Landing Systems, [http://www.faa.gov/regulations\\_policies/orders\\_notices/index.cfm/go/document.current/documentNumber/6750.16](http://www.faa.gov/regulations_policies/orders_notices/index.cfm/go/document.current/documentNumber/6750.16).
- (19) Order 6750.36, Site Survey, Selection, and Engineering Documentation for ILS and Ancillary Aids, [http://www.faa.gov/regulations\\_policies/orders\\_notices/index.cfm/go/document.current/documentNumber/6750.36](http://www.faa.gov/regulations_policies/orders_notices/index.cfm/go/document.current/documentNumber/6750.36).
- (20) Order 6780.5, DME Installation Standards Handbook Type FA-96-39, [http://www.faa.gov/regulations\\_policies/orders\\_notices/index.cfm/go/document.current/documentNumber/6780.5](http://www.faa.gov/regulations_policies/orders_notices/index.cfm/go/document.current/documentNumber/6780.5).
- (21) Order 6820.9, VOR, VOR/DME, VORTAC Installation Standard Drawings, [http://www.faa.gov/regulations\\_policies/orders\\_notices/index.cfm/go/document.current/documentNumber/6820.9](http://www.faa.gov/regulations_policies/orders_notices/index.cfm/go/document.current/documentNumber/6820.9).
- (22) Order 6820.10, VOR, VOR/DME and VORTAC Siting Criteria, [http://www.faa.gov/regulations\\_policies/orders\\_notices/index.cfm/go/document.current/documentNumber/6820.10](http://www.faa.gov/regulations_policies/orders_notices/index.cfm/go/document.current/documentNumber/6820.10).
- (23) Order JO 6850.2, Visual Guidance Lighting Systems, [http://www.faa.gov/regulations\\_policies/orders\\_notices/index.cfm/go/document.information/documentID/321004](http://www.faa.gov/regulations_policies/orders_notices/index.cfm/go/document.information/documentID/321004).
- (24) Order 6850.10, Runway End Identifier Lighting (REIL) System Standard Drawings, [http://www.faa.gov/regulations\\_policies/orders\\_notices/index.cfm/go/document.current/documentNumber/6850.10](http://www.faa.gov/regulations_policies/orders_notices/index.cfm/go/document.current/documentNumber/6850.10).
- (25) Order 6850.19, Frangible Coupling, [http://www.faa.gov/regulations\\_policies/orders\\_notices/index.cfm/go/document.current/documentNumber/6850.19](http://www.faa.gov/regulations_policies/orders_notices/index.cfm/go/document.current/documentNumber/6850.19).
- (26) Order 6850.20, Medium Intensity Approach Lighting System Threshold Lighting Backfit, [http://www.faa.gov/regulations\\_policies/orders\\_notices/index.cfm/go/document.current/documentNumber/6850.20](http://www.faa.gov/regulations_policies/orders_notices/index.cfm/go/document.current/documentNumber/6850.20).
- (27) Order 6950.23, Cable Loop Communication Systems at Airport Facilities, [http://www.faa.gov/regulations\\_policies/orders\\_notices/index.cfm/go/document.current/documentNumber/6950.23](http://www.faa.gov/regulations_policies/orders_notices/index.cfm/go/document.current/documentNumber/6950.23).

(28) Order 7110.104, Non-Federal Automated Weather Observation System (AWOS) Connection to the Weather Messaging Switching, [http://www.faa.gov/regulations\\_policies/orders\\_notices/index.cfm/go/document.current/documentNumber/7110.104](http://www.faa.gov/regulations_policies/orders_notices/index.cfm/go/document.current/documentNumber/7110.104).

(29) Order JO 7400.2, Procedures for Handling Airspace Matters, [http://www.faa.gov/regulations\\_policies/orders\\_notices/index.cfm/go/document.current/documentNumber/7400.2](http://www.faa.gov/regulations_policies/orders_notices/index.cfm/go/document.current/documentNumber/7400.2).

(30) Order 8200.1, United States Standard Flight Inspection Manual, [http://www.faa.gov/regulations\\_policies/orders\\_notices/index.cfm/go/document.current/documentNumber/8200.1](http://www.faa.gov/regulations_policies/orders_notices/index.cfm/go/document.current/documentNumber/8200.1).

(31) Order 8260.3, United States Standard for Terminal Instrument Procedures (TERPS), [http://www.faa.gov/regulations\\_policies/orders\\_notices/index.cfm/go/document.information/documentID/11698](http://www.faa.gov/regulations_policies/orders_notices/index.cfm/go/document.information/documentID/11698).

(32) Other Orders in the 8260 series, [http://www.faa.gov/regulations\\_policies/orders\\_notices/index.cfm/go/document.list?omni=OrdersNotices&q=8260&documentTypeIDList=2&display=all&parentTopicID=0&documentNumber=](http://www.faa.gov/regulations_policies/orders_notices/index.cfm/go/document.list?omni=OrdersNotices&q=8260&documentTypeIDList=2&display=all&parentTopicID=0&documentNumber=).

**d. Federal Regulations.**

(1) 14 CFR Part 1, Definitions and Abbreviations, <http://www.ecfr.gov/cgi-bin/text-idx?c=ecfr&sid=fab9bfa191e740463dbdb9acc14b6e2a&rgn=div5&view=text&node=14:1.0.1.1.1&idno=14>.

(2) 14 CFR Part 23, Airworthiness Standards: Normal, Utility, Acrobatic, and Commuter Category Airplanes, <http://www.ecfr.gov/cgi-bin/text-idx?c=ecfr&sid=fab9bfa191e740463dbdb9acc14b6e2a&rgn=div5&view=text&node=14:1.0.1.3.10&idno=14>.

(3) 14 CFR Part 25, Airworthiness Standards: Transport Category Airplanes, <http://www.ecfr.gov/cgi-bin/text-idx?c=ecfr&sid=fab9bfa191e740463dbdb9acc14b6e2a&rgn=div5&view=text&node=14:1.0.1.3.11&idno=14>.

(4) 14 CFR Part 77, Safe, Efficient Use, and Preservation of the Navigable Airspace, <http://www.ecfr.gov/cgi-bin/text-idx?c=ecfr&sid=fab9bfa191e740463dbdb9acc14b6e2a&rgn=div5&view=text&node=14:2.0.1.2.9&idno=14>.

(5) 14 CFR Part 91, General Operating and Flight Rules, <http://www.ecfr.gov/cgi-bin/text-idx?c=ecfr&sid=fab9bfa191e740463dbdb9acc14b6e2a&rgn=div5&view=text&node=14:2.0.1.3.10&idno=14>.

(6) 14 CFR Part 97, Standard Instrument Procedures, <http://www.ecfr.gov/cgi-bin/text-idx?c=ecfr&sid=fab9bfa191e740463dbdb9acc14b6e2a&rgn=div5&view=text&node=14:2.0.1.3.13&idno=14>.

(7) 14 CFR Part 121, Operating Requirements: Domestic, Flag, and Supplemental Operations, <http://www.ecfr.gov/cgi-bin/text-idx?c=ecfr&sid=fab9bfa191e740463dbdb9acc14b6e2a&rgn=div5&view=text&node=14:3.0.1.1.7&idno=14>.

(8) 14 CFR Part 129, Operations: Foreign Air Carriers and Foreign Operators of U.S.-Registered Aircraft Engaged in Common Carriage, <http://www.ecfr.gov/cgi-bin/text-idx?c=ecfr&sid=fab9bfa191e740463dbdb9acc14b6e2a&rgn=div5&view=text&node=14:3.0.1.1.9&idno=14>.

(9) 14 CFR Part 135, Operating Requirements: Commuter and On Demand Operations and Rules Governing Persons On Board Such Aircraft, <http://www.ecfr.gov/cgi-bin/text-idx?c=ecfr&sid=fab9bfa191e740463dbdb9acc14b6e2a&rgn=div5&view=text&node=14:3.0.1.1.11&idno=14>.

(10) 14 CFR Part 139, Certification of Airports, <http://www.ecfr.gov/cgi-bin/text-idx?c=ecfr&sid=fab9bfa191e740463dbdb9acc14b6e2a&rgn=div5&view=text&node=14:3.0.1.1.14&idno=14>.

(11) 14 CFR Part 150, Airport Noise Compatibility Planning, <http://www.ecfr.gov/cgi-bin/text-idx?c=ecfr&sid=fab9bfa191e740463dbdb9acc14b6e2a&rgn=div5&view=text&node=14:3.0.1.3.21&idno=14>.

(12) 14 CFR Part 151, Federal Aid to Airports, <http://www.ecfr.gov/cgi-bin/text-idx?c=ecfr&sid=fab9bfa191e740463dbdb9acc14b6e2a&rgn=div5&view=text&node=14:3.0.1.3.22&idno=1>.

(13) 14 CFR Part 152, Airport Aid Program, <http://www.ecfr.gov/cgi-bin/text-idx?c=ecfr&sid=fab9bfa191e740463dbdb9acc14b6e2a&rgn=div5&view=text&node=14:3.0.1.3.23&idno=14>.

(14) 14 CFR Part 157, Notice of Construction, Alteration, Activation, and Deactivation of Airports, <http://www.ecfr.gov/cgi-bin/text-idx?c=ecfr&sid=fab9bfa191e740463dbdb9acc14b6e2a&rgn=div5&view=text&node=14:3.0.1.3.27&idno=14>.

(15) 14 CFR Part 171, Non-Federal Navigation Facilities, <http://www.ecfr.gov/cgi-bin/text->



[idx?c=ecfr&sid=fab9bfa191e740463dbdb9acc14b6e2a&rgn=div5&view=text&node=14:3.0.1.4.32&idno=14](http://www.ecfr.gov/cgi-bin/text-idx?c=ecfr&sid=fab9bfa191e740463dbdb9acc14b6e2a&rgn=div5&view=text&node=14:3.0.1.4.32&idno=14).

(16) 49 CFR, Chapter XII, Parts 1500 through 1699, [http://www.ecfr.gov/cgi-bin/text-idx?sid=82e39459c7b60fa3ca608515797ea1c5&c=ecfr&tpl=/ecfrbrowse/Title49/49cfrv9\\_02.tpl#1200](http://www.ecfr.gov/cgi-bin/text-idx?sid=82e39459c7b60fa3ca608515797ea1c5&c=ecfr&tpl=/ecfrbrowse/Title49/49cfrv9_02.tpl#1200).

(17) 49 CFR Part 24, Uniform Relocation Assistance and Real Property Acquisition for Federal and Federally-Assisted Programs, <http://www.ecfr.gov/cgi-bin/text-idx?c=ecfr&sid=f8c021cea6b0746900717e84b2fe6ccd&rgn=div5&view=text&node=49:1.0.1.1.18&idno=49>.

(18) 49 USC Chapter 401, General Provisions, <http://www.gpo.gov/fdsys/granule/USCODE-2011-title49/USCODE-2011-title49-subtitleVII-partA-subparti-chap401/content-detail.html>.

(19) 49 USC Chapter 471, Airport Development, <http://www.gpo.gov/fdsys/granule/USCODE-2011-title49/USCODE-2011-title49-subtitleVII-partB-chap471/content-detail.html>.

(20) 49 CFR Part 1540, Civil Aviation Security: General Rules, <http://www.ecfr.gov/cgi-bin/text-idx?c=ecfr;sid=bea8e3d217db2cf2a562c85911cc3f7f;rgn=div5;view=text;node=49%3A9.1.3.5.9;idno=49;cc=ecfr>.

(21) 49 CFR Part 1542, Airport Security, <http://www.ecfr.gov/cgi-bin/text-idx?c=ecfr&sid=f8c021cea6b0746900717e84b2fe6ccd&rgn=div5&view=text&node=49:9.1.3.5.10&idno=49>.

(22) 49 CFR Part 1544, Aircraft Operator Security: Air Carriers and Commercial Operators, <http://www.ecfr.gov/cgi-bin/text-idx?c=ecfr&sid=f8c021cea6b0746900717e84b2fe6ccd&rgn=div5&view=text&node=49:9.1.3.5.11&idno=49>.

(23) 49 CFR Part 1546, Foreign Air Carrier Security <http://www.ecfr.gov/cgi-bin/text-idx?c=ecfr&sid=f8c021cea6b0746900717e84b2fe6ccd&rgn=div5&view=text&node=49:9.1.3.5.12&idno=49>.

(24) 49 CFR Part 1548, Indirect Air Carrier Security, <http://www.ecfr.gov/cgi-bin/text-idx?c=ecfr&sid=f8c021cea6b0746900717e84b2fe6ccd&rgn=div5&view=text&node=49:9.1.3.5.13&idno=49>.

(25) 49 CFR Part 1549, Certified Cargo Screening Program, [http://www.ecfr.gov/cgi-bin/text-](http://www.ecfr.gov/cgi-bin/text-idx?c=ecfr&sid=f8c021cea6b0746900717e84b2fe6ccd&rgn=div5&view=text&node=49:9.1.3.5.14&idno=49)

[idx?c=ecfr&sid=f8c021cea6b0746900717e84b2fe6ccd&rgn=div5&view=text&node=49:9.1.3.5.14&idno=49](http://www.ecfr.gov/cgi-bin/text-idx?c=ecfr&sid=f8c021cea6b0746900717e84b2fe6ccd&rgn=div5&view=text&node=49:9.1.3.5.14&idno=49).

(26) 49 CFR Part 1550, Aircraft Security under General Operating and Flight Rules, <http://www.ecfr.gov/cgi-bin/text-idx?c=ecfr&sid=f8c021cea6b0746900717e84b2fe6ccd&rgn=div5&view=text&node=49:9.1.3.5.15&idno=49>.

(27) 49 CFR Part 1552, Flight Schools, <http://www.ecfr.gov/cgi-bin/text-idx?c=ecfr&sid=f8c021cea6b0746900717e84b2fe6ccd&rgn=div5&view=text&node=49:9.1.3.5.16&idno=49>.

(28) 49 CFR Part 1560, Secure Flight Program, <http://www.ecfr.gov/cgi-bin/text-idx?c=ecfr&sid=f8c021cea6b0746900717e84b2fe6ccd&rgn=div5&view=text&node=49:9.1.3.5.17&idno=49>.

(29) 49 CFR Part 1562, Operations in the Washington, DC, Metropolitan Area, <http://www.ecfr.gov/cgi-bin/text-idx?c=ecfr&sid=f8c021cea6b0746900717e84b2fe6ccd&rgn=div5&view=text&node=49:9.1.3.5.18&idno=49>.

**e. FAA Forms.**

(1) Form 5010, Airport Master Record, <http://www.faa.gov/forms/index.cfm/go/document.list?omni=Forms&q=5010&parentTopicID=0&display=current&subjectClassPrefix=&documentNumber=>.

(2) Form 7460-1, Notice of Proposed Construction or Alteration, <http://www.faa.gov/forms/index.cfm/go/document.information/documentID/186273>.

(3) Form 7480-1, Notice of Landing Area Proposal, <http://www.faa.gov/forms/index.cfm/go/document.information/documentID/185334>.

**f. Other.**

(1) Aeronautical Information Manual (AIM), [http://www.faa.gov/air\\_traffic/publications/atpubs/aim/](http://www.faa.gov/air_traffic/publications/atpubs/aim/).

(2) Aeronautical Information Publication, [http://www.faa.gov/air\\_traffic/publications/media/aip.pdf](http://www.faa.gov/air_traffic/publications/media/aip.pdf).

(3) Airport Cooperative Research Program (ACRP) Report 25, Airport Passenger Terminal Planning and Design, Volume I, [http://onlinepubs.trb.org/onlinepubs/acrp/acrp\\_rpt\\_025v1.pdf](http://onlinepubs.trb.org/onlinepubs/acrp/acrp_rpt_025v1.pdf).

- (4)** Airport/Facility Directory (A/FD), [http://www.faa.gov/air\\_traffic/flight\\_info/aeronav/productcatalog/supplementalcharts/AirportDirectory/](http://www.faa.gov/air_traffic/flight_info/aeronav/productcatalog/supplementalcharts/AirportDirectory/).
- (5)** American Association of State Highway and Transportation Officials (AASHTO) M268, Standard Specification for Retroreflective Sheeting for Flat and Vertical Traffic Control Applications.
- (6)** American Society for Testing and Materials International (ASTM) D4956, Standard Specification for Retroreflective Sheeting for Traffic Control, <http://www.astm.org/Standards/D4956.htm>.
- (7)** ASTM E810, Standard Test Method for Coefficient of Retroreflection of Retroreflective Sheeting Utilizing the Coplanar Geometry, <http://www.astm.org/Standards/E810.htm>.
- (8)** FAA Airport Diagrams, [http://aeronav.faa.gov/index.asp?xml=aeronav/applications/d\\_tpp](http://aeronav.faa.gov/index.asp?xml=aeronav/applications/d_tpp).
- (9)** FAA Memorandum, Interim Guidance on Land Uses Within a Runway Protection Zone, dated 9/27/2012.
- (10)** FAA/USDA manual, Wildlife Hazard Management at Airports, [http://www.faa.gov/airports/airport\\_safety/wildlife/problem/media/2005\\_FAA\\_Manual\\_complete.pdf](http://www.faa.gov/airports/airport_safety/wildlife/problem/media/2005_FAA_Manual_complete.pdf).
- (11)** FAA-C-1217, Electrical Work, Interior, [https://faaco.faa.gov/attachments/attachment\\_3.pdf](https://faaco.faa.gov/attachments/attachment_3.pdf).
- (12)** FAA-C-1391, Installation and Splicing of Underground Cables, <https://faaco.faa.gov/attachments/FAA-C-1391b1.pdf>.
- (13)** FAA-STD-019, Lightning and Surge Protection, Grounding, Bonding and Shielding Requirements for Facilities and Electronics Equipment, <https://faaco.faa.gov/attachments/STD-019e2.pdf>.
- (14)** Federal Specification FP-85, Standard Specifications for Construction of Roads and Bridges on Federal Highway Projects.
- (15)** Grant Assurances No. 20, Hazard Removal and Mitigation, No. 21, Compatible Land Use, No. 34, Policies, Standards, and Specifications, and PFC Assurance No. 9, Standards and Specifications, [http://www.faa.gov/airports/aip/grant\\_assurances/media/airport\\_sponsor\\_assurances\\_2012.pdf](http://www.faa.gov/airports/aip/grant_assurances/media/airport_sponsor_assurances_2012.pdf).
- (16)** Illuminating Engineering Society of North America (IES), Recommended Practice for Airport Service Area Lighting.

(17) International Air Transport Association (IATA), Airport Development Reference Manual (ADRM).

(18) NASA/Aviation Safety Reporting System (ASRS) Directline Issue No. 6, August 1993, Ground Jet Blast Hazard, [http://asrs.arc.nasa.gov/publications/directline/dl6\\_blast.htm](http://asrs.arc.nasa.gov/publications/directline/dl6_blast.htm).

(19) National Fire Protection Association (NFPA) 407, Standard for Aircraft Fuel Servicing, <http://www.nfpa.org/aboutthecodes/AboutTheCodes.asp?DocNum=407>.

(20) NFPA 409, Standard on Aircraft Hangars, <http://www.nfpa.org/aboutthecodes/AboutTheCodes.asp?DocNum=409>.

(21) NFPA 415, Standard on Airport Terminal Building, Fueling Ramp Drainage and Loading Walkways, <http://www.nfpa.org/aboutthecodes/AboutTheCodes.asp?DocNum=415>.

(22) Transportation Security Administration document, Recommended Security Guidelines for Airport Planning and Construction, [http://www.tsa.gov/sites/default/files/assets/pdf/airport\\_security\\_design\\_guidelines.pdf](http://www.tsa.gov/sites/default/files/assets/pdf/airport_security_design_guidelines.pdf).

(23) Transportation Security Administration Information Publication A-001, Security Guidelines for General Aviation Airports, [http://www.tsa.gov/sites/default/files/assets/pdf/Intermodal/security\\_guidelines\\_for\\_general\\_aviation\\_airports.pdf](http://www.tsa.gov/sites/default/files/assets/pdf/Intermodal/security_guidelines_for_general_aviation_airports.pdf).

**109. to 199. Reserved.**

## Chapter 2. Design Process

### 201. General.

Airport design first requires selecting the Runway Design Code(s) (RDC[s]) (see paragraph 105.c), for desired/planned level of service for each runway, and then applying the airport design criteria associated with the RDC. Table 2-1 depicts the changes in design standards associated with changes in the approach category and airplane design group. Table 2-2 depicts the change in design standards associated with changes in visibility minimums.

**a.** Instrument flight procedures minimums are based on the characteristics and infrastructure of the runway (i.e., markings, approach light system, protected airspace, etc.), airspace evaluation, and the navigation system available to the aircraft. Unless these items are considered in the development of the airport, the operational minimums may be other than desired.

**b.** For airports with two or more runways, it is often desirable to design all airport elements to meet the requirements of the most demanding RDC and Taxiway Design Group (TDG). However, it may be more practical and economical to design some airport elements, e.g., a secondary runway and its associated taxiway, to standards associated with a lesser demanding RDC and TDG. A typical example would be an air carrier airport that has a separate general aviation or commuter runway or a crosswind runway only needed for small aircraft.

**Table 2-1. Changes in airport design standards associated with an upgrade in the first two components (Aircraft Approach Category [AAC] and Airplane Design Group [ADG]) of the Runway Design Code (RDC)**

AAC/RDC upgrade	Changes in airport design standards.
A-I* to B-I*	No change in airport design standards.
B-I* to C-I	<p>Increase in crosswind component. Refer to paragraph <a href="#">302.c(3)</a> and <a href="#">Table 3-1</a>.</p> <p>Increase in runway separation standards. Refer to interactive <a href="#">Table 3-5</a> and <a href="#">Table 3-6</a>.</p> <p>Increase in RPZ dimensions. Refer to <a href="#">Table 3-5</a> and paragraph <a href="#">310.c</a>.</p> <p>Increase in OFZ dimensions. Refer to paragraph <a href="#">308</a>.</p> <p>Increase in runway design standards. Refer to <a href="#">Table 3-5</a>.</p> <p>Increase in surface gradient standards. Refer to paragraph <a href="#">313</a>, <a href="#">Figure 4-33</a>, paragraph <a href="#">418</a>, and paragraph <a href="#">508</a>.</p> <p>Increase in threshold siting standards. Refer to paragraph <a href="#">303</a>.</p>
A-I to B-I	No change in airport design standards.
B-I to C-I	<p>Increase in crosswind component. Refer to paragraph <a href="#">302.c(3)</a> and <a href="#">Table 3-1</a>.</p> <p>Increase in runway separation standards. Refer to <a href="#">Table 3-5</a> and <a href="#">Table 3-6</a>.</p> <p>Increase in RPZ dimensions. Refer to <a href="#">Table 3-5</a> and paragraph <a href="#">310.c</a>.</p> <p>Increase in runway design standards. Refer to <a href="#">Table 3-5</a>.</p> <p>Increase in surface gradient standards. Refer to paragraphs <a href="#">313</a>, <a href="#">Figure 4-33</a>, paragraph <a href="#">418</a>, and paragraph <a href="#">508</a>.</p>
A-II to B-II	No change in airport design standards.
B-II to C-II	<p>Increase in crosswind component. Refer to paragraph <a href="#">302.c(3)</a> and <a href="#">Table 3-1</a>.</p> <p>Increase in runway separation standards. Refer to <a href="#">Table 3-5</a> and <a href="#">Table 3-6</a>.</p> <p>Increase in RPZ dimensions. Refer to <a href="#">Table 3-5</a> and paragraph <a href="#">310.c</a>.</p> <p>Increase in runway design standards. Refer to <a href="#">Table 3-5</a>.</p> <p>Increase in surface gradient standards. Refer to paragraph <a href="#">313</a>, <a href="#">Figure 4-33</a>, paragraph <a href="#">418</a> and paragraph <a href="#">508</a>.</p>
A-III to B-III	No change in airport standards.
B-III to C-III	<p>Increase in runway separation standards. Refer to <a href="#">Table 3-5</a> and <a href="#">Table 3-6</a>.</p> <p>Increase in RPZ dimensions. Refer to <a href="#">Table 3-5</a> and paragraph <a href="#">310.c</a>.</p> <p>Increase in runway design standards. Refer to <a href="#">Table 3-5</a>.</p> <p>Increase in surface gradient standards. Refer to paragraph <a href="#">313</a>, <a href="#">Figure 4-33</a>, paragraph <a href="#">418</a> and paragraph <a href="#">508</a>.</p>
A-IV to B-IV	No change in airport design standards.
B-IV to C-IV	<p>Increase in RPZ dimensions. Refer to <a href="#">Table 3-5</a> and paragraph <a href="#">310.c</a>.</p> <p>Increase in surface gradient standards. Refer to paragraph <a href="#">313</a>, <a href="#">Figure 4-33</a>, paragraph <a href="#">418</a> and paragraph <a href="#">508</a>.</p>
C-I to D-I	Increase in runway design standards. Refer to <a href="#">Table 3-5</a> .
C-II to D-II	Increase in runway design standards. Refer to <a href="#">Table 3-5</a> .

\* These airport design standards pertain to facilities designed for small aircraft.

**Table 2-2. Changes in airport design standards associated with lowering the third component (approach visibility minimums) of the Runway Design Code (RDC)**

Visibility minimums*	Changes in airport design standards
Visual to Not lower than 1-mile	No change in airport design standards.
Not lower than 1-mile to Not lower than 3/4-mile	Parallel Taxiway Increase in RPZ dimensions. Refer to interactive <a href="#">Table 3-5</a> . Increase in threshold siting standards. Refer to paragraph <a href="#">303</a> .
Not lower than 3/4-mile to Not lower than CAT-I	For aircraft approach categories A & B runways: Increase in runway separation standards. Refer to <a href="#">Table 3-5</a> and <a href="#">Table 3-6</a> . Increase in RPZ dimensions. Refer to <a href="#">Table 3-5</a> . Increase in OFZ dimensions. Refer to paragraph <a href="#">308</a> . Increase in runway design standards. Refer to <a href="#">Table 3-5</a> . Increase in threshold siting standards. Refer to paragraph <a href="#">303</a> .
	For aircraft approach categories C, D, & E runways: Increase in runway separation standards for ADG-I & ADG-II runways. Refer to <a href="#">Table 3-5</a> and <a href="#">Table 3-6</a> . Increase in RPZ dimensions. Refer to <a href="#">Table 3-5</a> . Increase in OFZ dimensions. Refer to paragraph <a href="#">308</a> . Increase in threshold siting standards. Refer to paragraph <a href="#">303</a> .
Not lower than CAT-I to Lower than CAT-I	Increase in OFZ dimensions for runways serving large aircraft. Refer to paragraph <a href="#">308</a> . Increase in threshold siting standards. Refer to paragraph <a href="#">303</a> .

\* In addition to the changes in airport design standards as noted, providing for lower approach visibility minimums may result in an increase in the number of objects identified as obstructions to air navigation in accordance with [Part 77](#). This may require object removal or marking and lighting. Refer to paragraph [306](#).

## 202. Design aircraft.

The design aircraft enables airport planners and engineers to design the airport in such a way as to satisfy the operational requirements of such aircraft and meet national standards for separation and geometric design (safety issues). The “design” aircraft may be a single aircraft or a composite of several different aircraft composed of the most demanding characteristics of each (see paragraph [105.b](#)). Examples of such characteristics and the design components affected are detailed in [Table 2-3](#). The selection of the design aircraft is beyond the scope of this AC.

**Table 2-3. Aircraft characteristics and design components**

<b>Aircraft Characteristics</b>	<b>Design Components</b>
Approach Speed	RSA, ROFA, RPZ, runway width, runway-to-taxiway separation, runway-to-fixed object.
Landing and Takeoff Distance	Runway length
Cockpit to Main Gear Distance (CMG)	Fillet design, apron area, parking layout
Main Gear Width (MGW)	Taxiway width, fillet design
Wingspan / Tail Height	Taxiway and apron OFA, parking configuration, hangar locations, taxiway-to-taxiway separation, runway to taxiway separation

**203. Runway incursions.**

The overall airfield design should be developed with the intent of preventing runway incursions. Taxiway design and runway incursion prevention are discussed in [Chapter 4](#).

**204. Airport design standards and the environmental process.**

**a. Purpose and Need.** For projects using funds from federal financial assistance programs, design standards in this advisory circular (AC) represent the key components of the airport that are needed to fulfill the federal mission and policy as stipulated by USC Title 49, [Chapter 471](#), Airport Development. [Chapter 471](#) requires balancing a variety of interests associated with the airports, including:

- Safe operations
- Increasing capacity and efficiency
- Delay reduction
- Economic viability
- Noise reduction
- Environmental protection

These standards work to balance these interests. For normal environmental processes, these standards establish the fundamental purpose and need for airport development.

**b. Safety.** All prudent and feasible alternatives must be considered when a proposed development project has potential environmental effects. However, safety is the highest priority for any airport development and any airport operations.



## 205. Planned visibility minimums for instrument procedures.

Runways provide maximum utility when they can be used in less than ideal weather conditions. For runways, weather conditions translate to visibility in terms of the distance to see and identify prominent unlighted objects by day and prominent lighted objects by night. In order to land during periods of limited visibility, pilots must be able to see the runway or associated lighting at a certain distance from and height above the runway. If the runway environment cannot be identified at the minimum visibility point on the approach, FAA regulations do not authorize pilots to land.

**a. Planning considerations.** While lower visibility minimums are often desirable, runway design requirements ranging from obstacles in the approach path to separation and buffers around the runway become much more restrictive. Therefore, it is important to carefully weigh the demand, benefits and costs when deciding the visibility minimums for which the runway will be designed.

**b. Visibility categories.** The ultimate runway development should be designed for one of the following visibility categories:

(1) Visual (V). Runways classified as visual are not designed to handle or anticipated to handle any Instrument Flight Rules (IFR) operations now or in the future, except circling approaches. These runways support Visual Flight Rules (VFR) operations only and are unlighted or lighted with at least Low Intensity Runway Lights (LIRL) or medium intensity runway lights (MIRL), and have only visual (basic) runway markings as defined in AC 150/5340-1.

(2) Non-Precision Approach (NPA). Runways classified as NPA are designed to handle straight-in instrument approaches providing only lateral guidance. NPA runways will only support IFR approach operations to visibilities of 3/4 statute mile (1.2 km) or greater. Navigation Aids (NAVAIDs) providing lateral only guidance for instrument approaches are VHF Omnidirectional Range (VOR), non-directional beacon (NDB), Area Navigation (RNAV) Lateral Navigation (LNAV), localizer performance (LP), localizer (LOC). These runways are generally at least 3,200 feet (975 m) long, with a minimum width based on RDC, are lighted using at least LIRL or MIRL, and have non-precision runway markings as defined in AC 150/5340-1. Runways less than 3,200 feet are protected by Part 77 to a lesser extent. However, runways as short as 2,400 feet could support an instrument approach provided the lowest Height Above Threshold (HATh) is based on clearing any 200-foot (61 m) obstacle within the final approach segment.

(3) Approach Procedure with Vertical Guidance (APV). Runways classified as APV are designed to handle instrument approach operations where the navigation system provides vertical guidance down to 250 feet HATh and visibilities to as low as 3/4 statute mile. May apply to the following approach types: Instrument Landing System (ILS), LNAV/ Vertical Navigation (VNAV), Localizer Performance with Vertical Guidance (LPV), or Area Navigation (RNAV)/Required Navigation Performance (RNP). These runways must be at least 3,200 feet (975 m) in length with a width at least 60 feet (18.5 m) (with 75 or 100 feet [23 or 30 m]

typically being optimum), and must have at least MIRL with non-precision runway markings as defined in AC 150/5340-1.

(4) Precision Approach (PA). Runways classified as precision are designed to handle instrument approach operations supporting instrument approach with HATh lower than 250 feet and visibility lower than 3/4 statute mile, down to and including Category (CAT) III. Precision Instrument Runways (PIR) support IFR operations with visibilities down to and including CAT-III with the appropriate infrastructure. The navigational systems capable of supporting precision operations are ILS, LPV, and Global Navigation Satellite System (GNSS) Landing System (GLS). These runways must be at least 4200 feet (1280 m) long, and are at least 75 feet (23 m) wide with the typical width being at least 100 feet (30 m). These runways are typically lighted by High Intensity Runway Lights (HIRL) and must have precision runway markings as defined in AC 150/5340-1.

## 206. Airport Traffic Control Tower (ATCT) siting.

a. **General.** The ATCT should be constructed at the minimum height required to satisfy all siting criteria. Order 6480.4 provides guidance on siting criteria and the evaluation and approval procedures for the height and location of an ATCT to ensure safety within the National Airspace System (NAS). The existing (or future) ATCT must have a clear line of sight (LOS) to: all traffic patterns, the final approaches to all runways, all runway structural pavement, and other operational surfaces controlled by Air Traffic Control (ATC). A clear LOS to taxiway centerlines is desirable. Operational surfaces not having a clear unobstructed LOS from the ATCT are designated by ATC as non-movement areas through a local agreement with the airport owner.

b. **Land requirements.** From ATCTs, ATC personnel control flight operations within the airport's designated airspace and the operation of aircraft and vehicles on the movement area. A typical ATCT site will range from 3 to 7 acres. Additional land may be needed for combined ATC facilities. The proposed site must consider security requirements and be large enough to accommodate current and future building needs, including reasonable provisions for employee parking.

c. **Considerations for planned runway and/or taxiway extensions.** During the planning of a runway or taxiway extension, the existing ATCT site should be evaluated for impacts from the extension, such as object discrimination, unobstructed view, and two-point lateral discrimination (depth perception).

d. **Considerations for planned taxiway construction projects.** During the planning of a taxiway construction project, the existing ATCT site should be evaluated for impacts due to construction, such as an unobstructed view from construction equipment and/or activities, temporary and/or permanent changes in taxiing patterns, and changes to aircraft operations.

e. **Considerations for planned buildings.** When planning on-airport buildings, such as terminal buildings, hangars, snow removal equipment buildings, aircraft rescue and fire

fighting (ARFF) buildings, the existing ATCT site should be evaluated for impacts from the project, such as clear LOS, glare, and smoke or vapor plume.

### **207. Airport Reference Point (ARP).**

The ARP is the geometric center of all usable runways at the airport. The FAA uses the ARP to establish the official horizontal geographic location for the airport. The ARP is normally not monumented or physically marked on the ground. The location of the ARP is computed using runway length and is typically presented for both the existing and ultimate runway lengths proposed for development. This allows the FAA to adequately protect the existing and ultimate airspace surrounding the airport. These computations do not use closed or abandoned areas. The FAA-approved Airport Layout Plan (ALP) shows the ultimate development. If there is no ALP, the ultimate runway lengths are the existing runways plus those which have airspace approval, less closed or abandoned areas. Once the ARP is computed, the only time that a recomputation is needed is when the proposed ultimate development is changed. Refer to AC 150/5300-18 for specific calculation requirements and further guidance.

### **208. Heliports/helipads.**

Refer to AC 150/5390-2 for guidance on helicopter facilities on airports. AC 150/5390-2 provides recommended distances between the helicopter Final Approach and Takeoff Area (FATO) center to runway centerline. Safety area dimensions for helipads are also discussed.

### **209. Other aeronautical uses on airports.**

**a. Light sport aircraft and ultralights.** Aircraft in this category have a maximum takeoff weight of less than 1,320 lbs (599 kg) and 254 lbs (115 kg) respectively, and a maximum stall speed of not more than 45 knots and 24 knots respectively. Since these aircraft regularly operate on turf runways, follow the guidance in paragraph 314. Otherwise, use the standards in this AC for small aircraft with approach speeds of more than 50 knots, and less than 50 knots, respectively. Refer to AC 103-6 for further guidance.

**b. Seaplanes.** Refer to AC 150/5395-1.

**c. Skydiving.** Contact the appropriate FAA Airports office for guidance.

**d. Unmanned Aircraft Systems (UAS).** Contact the appropriate FAA Airports office for guidance.

### **210. Drainage considerations.**

The objective of storm drainage design is to provide for safe passage of vehicles or operation of the facility during the design storm event. Design considerations are discussed in more detail below. Refer to AC 150/5320-5 for further guidance on the design of storm drainage systems. In addition, storm drainage systems must meet local requirements.

**a. Design objectives.** The drainage system should be designed to:

- (1) Provide for surface drainage by the rapid removal of storm water from the airfield pavement including the drainage of the pavement base or subbase by a subdrain system.
- (2) Provide an efficient mechanism for collecting airfield flows and conveying design flows to acceptable discharge points.
- (3) Provide levels of storm water conveyance that protect airfield pavements and embankments from damage during large storm water events. Additionally any improvements required for airport operations such as utilities and NAVAIDs should be similarly protected.
- (4) Provide for a safe level of operation for both airside and landside ground vehicles.
- (5) Address storm water quality issues in accordance with individual National Pollution Discharge Elimination System (NPDES) and state and local permit requirements.
- (6) Account for future airport expansion and grading requirements. Future storm water management needs should be considered in airport planning efforts, including master plans.
- (7) Follow airfield design requirements for safety areas and Object Free Areas (OFAs).

**b. Storm drain design.** Storm runoff must be effectively removed to avoid interruption of operations during or following storms and to prevent temporary or permanent damage to pavement subgrades. Removal is accomplished by a drainage system unique to each site. Drainage systems will vary in design and extent depending upon local soil conditions and topography; size of the physical facility; vegetation cover (or its absence); the anticipated presence, or absence, of ponding; and local storm intensity and frequency patterns. The drainage system should function with a minimum of maintenance difficulties and expense and should be adaptable to future expansion. Open channels or natural water courses are permitted only at the periphery of an airfield. Subdrains are used to drain the base material, lower the water table, or drain perched water tables. Fluctuations of the water table must be considered in the initial design of the facility.

**c. Storm water control facilities.** Construction improvements on airports often convert natural pervious areas to impervious areas. These activities cause increased runoff because infiltration is reduced, the surface is usually smoother, allowing more rapid drainage, and depression storage is usually reduced. In addition, natural drainage systems are often replaced by lined channels or storm drains. These man-made systems produce an increase in runoff volume and peak discharge. One of the fundamental objectives of storm water management is to maintain the peak runoff rate from a developing area at or below the pre-development rate to control flooding, soil erosion, sedimentation, and pollution.

**d. Water quality considerations.** Employ best management practices (BMPs) to mitigate the adverse impacts of development activity. Regulatory control for water quality practices is driven by NPDES requirements under such programs as the Clean Water Act and

state and local requirements. Refer to AC 150/5320-15 for guidance on the management and regulations of industrial waste generated at airports.

**e. Wildlife concerns.** Designs for storm drainage management infrastructure should incorporate additional design elements found in AC 150/5200-33 to address wildlife hazard attractant concerns.

## **211. Security of airports.**

The focus of airport security is to identify and reduce existing or potential risks, threats, targets and vulnerabilities to the facility. Appropriate protective measures vary dependent on the level of threat and the class of operator and airport. There is no universal standard at this time. The Transportation Security Administration document, Recommended Security Guidelines for Airport Planning and Construction, provides more specific information.

**a. Threat and security measures.** During design, consider potential types of attack or threat to the facility, and how to incorporate associated security measures for each. Additional information on providing security for building occupants and assets is available from the Whole Building Design Group (WBDG). See its website at [www.wbdg.org/design/provide\\_security.php](http://www.wbdg.org/design/provide_security.php) for recommendations prepared by the WBDG Secure/Safe Committee.

### **b. FAA Regulations.**

**(1) Certificated Airports.** Airports Certificated under Part 139 must provide the following:

(a) Safeguards to prevent inadvertent entry to the movement area by unauthorized persons or vehicles.

(b) Reasonable protection of persons and property from aircraft jet blast or propeller wash.

(c) Fencing that meets the requirements of applicable FAA and Transportation Security Administration security regulations in areas subject to these regulations.

**(2) Military/U.S. Government-Operated Airports.** The FAA does not have the statutory authority to regulate airports operated by the U.S. Government agencies, including airports operated by the U.S. Department of Defense (DOD). Part 139 clarifies that the rule does not apply to these airports (see § 139.1[c][2]). However, in some instances, Part 139 requirements will apply to a civilian entity that has responsibility for a portion of an airport operated by the U.S. Government.

**(3) Airports with Civilian and Military Operations.** Airports where civilian and military operations commingle are known as either “joint-use airports” or “shared-use airports.” Under Part 139, civilian air carrier operations of either a joint-use or a shared-use airport must comply with Part 139 (see § 139.1[b] and § 139.5).

**c. Transportation Security Administration security regulations.** The Transportation Security Administration requires airport operators to implement a security program approved by the Transportation Security Administration. The security program includes requirements such as establishing secured areas, air operations areas, security identification display areas, and access control systems. The Transportation Security Administration issues and administers these requirements under the Transportation Security Regulations (TSRs), <http://www.tsa.gov/stakeholders/security-regulations>, which are codified in Title 49 CFR, Chapter XII, Parts 1500 through 1699. Refer to the following parts under Subchapter C – Civil Aviation Security for further guidance:

- (1) Part 1540, Civil Aviation Security: General Rules
- (2) Part 1542, Airport Security
- (3) Part 1544, Aircraft Operator Security: Air Carriers and Commercial Operators
- (4) Part 1546, Foreign Air Carrier Security
- (5) Part 1548, Indirect Air Carrier Security
- (6) Part 1549, Certified Cargo Screening Program
- (7) Part 1550, Aircraft Security Under General Operating and Flight Rules
- (8) Part 1552, Flight Schools
- (9) Part 1560, Secure Flight Program
- (10) Part 1562, Operations in the Washington, DC, Metropolitan Area

**d. DOD security regulations.** The Unified Facilities Criteria (UFC) ([www.wbdg.org](http://www.wbdg.org)) documents provide planning, design, construction, sustainment, restoration, and modernization criteria.

## **212. Pavement strength and design.**

**a. General.** Airfield pavements are constructed to provide adequate support for the loads imposed by aircraft using the airport as well as resisting the abrasive action of traffic and deterioration from adverse weather conditions and other influences. They are designed not only to withstand the loads of the heaviest aircraft expected to use the airport, but they must also be able to withstand the repetitive loadings of the entire range of aircraft expected to use the pavement over many years. Proper pavement strength design represents the most economical solution for long-term aviation needs. AC 150/5320-6 provides guidance for airfield pavement design.

**b. Surface friction treatment.** Airport pavements should provide a surface that is not slippery and will provide good traction during any weather conditions. Grooving or other

surface friction treatment should be provided for all primary and secondary runways at commercial service airports or where the runway serves turbojet operations. AC 150/5320-12 presents information on skid resistant surfaces.

**213. Location of on-airfield facilities.**

**a. Building Restriction Line (BRL).** A BRL is the line indicating where airport buildings must not be located, limiting building proximity to aircraft movement areas. A BRL should be placed on an ALP for identifying suitable building area locations on airports. The BRL should be set beyond the Runway Protection Zones (RPZs), the Obstacle Free Zones (OFZs), the Object Free Areas (OFAs), the runway visibility zone (see paragraph 305.c), NAVAID critical areas, areas required for TERPS, and ATCT clear line of sight (LOS). The location of the BRL is dependent upon the selected allowable structure height. A typical allowable structure height is 35 feet (10.5 m). The closer development is allowed to the Aircraft Operations Area (AOA), the more impact it will have on future expansion capabilities of the airport.

**b. Airport aprons.** Refer to Chapter 5 for the design standards for airport aprons and related activities for parking and storage of aircraft on an apron. The dimensions cited in interactive Table 3-5 present separation criteria applicable to aprons. For further passenger apron design criteria refer to AC 150/5360-13 and AC 150/5070-6.

**214. to 299. Reserved.**

**Page intentionally left blank.**



## Chapter 3. Runway Design

### 301. Introduction.

This chapter presents the design standards for runways and runway associated elements such as shoulders, blast pads, Runway Safety Areas (RSAs), Obstacle Free Zones (OFZs), Object Free Areas (OFAs), clearways, and stopways. In addition, this chapter presents design standards for runway end siting, object clearing, approach procedure development, and rescue and fire fighting access. The Runway Design Code (RDC) (see paragraph [105.c](#)) is used to determine the standards that apply to a specific runway and parallel taxiway to allow unrestricted operations by the design aircraft under desired meteorological conditions. Refer to the Runway Design Standards Matrix (interactive [Table 3-5](#)) for specific dimensional design criteria per RDC. Except as noted, dimensional standards are independent of the surface type of the runway.

### 302. Runway design concepts.

**a. Runway length.** The runway should be long enough to accommodate landing and departures for the design aircraft. [AC 150/5325-4](#) describes procedures for planning the appropriate runway length. Takeoff distances are often longer than landing distances. All aircraft operational considerations, to include the takeoff, landing, and accelerate stop distances, and obstacle clearance, need to be considered when determining runway length for the aircraft intended to use the runway.

**b. Runway ends.** Approach and departure surfaces should remain clear of obstacles, including aircraft, in order to prevent operational restrictions that might affect aircraft operating weights and visibility minimums. Paragraph [306](#) discusses the Obstacle Clearance Surfaces (OCSs) for various operating conditions. Be sure to consider ultimate runway length requirements as well as ultimate visibility minimum requirements when evaluating new runway locations.

**c. Runway location, orientation and wind coverage.** Runway location and orientation are paramount to airport safety, efficiency, economics, and environmental impact. The weight and degree of concern given to each of the following factors depend, in part, on: the RDC, the meteorological conditions, the surrounding environment, topography, and the volume of air traffic expected at the airport.

**(1) Orientation.** The primary runway, taking into considerations other factors; should be oriented in the direction of the prevailing wind.

**(2) Number of Runways.** The number of runways should be sufficient to meet air traffic demands, including arrivals, departures and aircraft mix at peak volume. The number of runways needed may also be affected by the need to overcome environmental impacts or minimize the effects of adverse wind conditions. See [Appendix 2](#) for wind analysis details. With rare exception, capacity-justified runways are parallel to the primary runway. See [AC 150/5060-5](#) for planning guidance.

(3) **Wind.** Wind data analysis for airport planning and design is discussed in [Appendix 2](#). The wind data analysis considers the wind speed and direction as related to the existing and forecasted operations during visual and instrument meteorological conditions. It may also consider wind by time of day. A crosswind runway is recommended when the primary runway orientation provides less than 95.0 percent wind coverage. The 95.0 percent wind coverage is computed on the basis of the crosswind component not exceeding the allowable value, as listed in [Table 3-1](#), per RDC.

**Table 3-1. Allowable crosswind component per Runway Design Code (RDC)**

RDC	Allowable Crosswind Component
A-I and B-I *	10.5 knots
A-II and B-II	13 knots
A-III, B-III, C-I through D-III D-I through D-III	16 knots
A-IV and B-IV, C-IV through C-VI, D-IV through D-VI	20 knots
E-I through E-VI	20 knots

\* Includes A-I and B-I small aircraft.

**d. Airspace analysis and obstruction to air navigation.**

(1) **Airspace Analysis.** Existing and planned Instrument Approach Procedures (IAP), missed approach procedures, departure procedures, Class B, C, D and/or E airspace, special use airspace, restricted airspace, and traffic patterns influence airport layouts and locations. Contact the FAA for assistance on airspace matters.

(2) **Obstructions to Air Navigation.** An obstruction survey should identify those objects that may affect aircraft operations. The runway should be oriented to provide a clear approach/departure path for intended level of service.

**e. Environmental factors.** In developing runways to be compatible with the airport environs, conduct environmental studies that consider the impact of existing and proposed land use and noise on nearby residents, air and water quality, wildlife, and historical/archeological features.

**f. Topography.** Topography affects the amount of grading and drainage work required to construct a runway. In determining runway orientation, consider the costs of both the initial work and ultimate airport development. See paragraphs [313](#), [418](#) and [508](#) and [AC 150/5320-5](#) for further guidance.

**g. Wildlife hazards.** In orienting runways, consider the relative locations of bird sanctuaries, sanitary landfills, or other areas that may attract large numbers of birds or other wildlife. Where bird hazards exist, develop and implement bird control procedures to minimize such hazards. See [AC 150/5200-33](#), [AC 150/5200-34](#), and FAA/USDA manual, [Wildlife Hazard](#)

**Management at Airports.** This manual may be used to determine, on a case-by-case basis, what uses may be compatible with a particular airport environment with respect to wildlife management. Review the airport's FAA-approved Wildlife Hazard Assessment if one exists. Guidance is also available through local FAA Airports offices.

**h. Survey requirements.** Surveys are done in accordance with AC 150/5300-16, AC 150/5300-17, and AC 150/5300-18.

**i. Runway markings.** AC 150/5340-1 addresses runway markings in detail.

**j. Navigation Aids (NAVAIDs).** Ground based NAVAIDs are often needed to provide desired approach minimums and instrument capabilities. Approach lighting systems (ALSs) can extend as far as 3,000 feet (914 m) out from the threshold. Ground-based electronic aids often need additional land area and clearances from runways, taxiways and other facilities that could interfere with the electronic signal. Chapter 6 provides guidance for locating NAVAIDs that support runways.

**k. Runway design standards.** As a minimum, runway design and runway extensions must evaluate the following design elements:

- (1) RSA, paragraph 307.
- (2) OFZ, paragraph 308.
- (3) Runway Object Free Area (ROFA), paragraph 309.
- (4) Runway Protection Zone (RPZ), paragraph 310.
- (5) Approach and Departure Surfaces, paragraphs 303.b and 303.c.
- (6) Runway to taxiway separation standards, interactive Table 3-5.
- (7) Runway visibility zone, Figure 3-7.
- (8) Threshold siting standards, Table 3-2.

**l. Landside interface.** Runways connect to taxiways that provide access to terminal facilities, aprons and cargo areas. Therefore, proper runway design must consider ultimate airport development and how these elements will relate to one another while providing a safe and efficient operation. Consider ultimate terminal expansion plans and the possibility of dual parallel taxiways to ensure that the runway is located far enough from the terminal. See Chapter 4 for more information on taxiway arrangement.

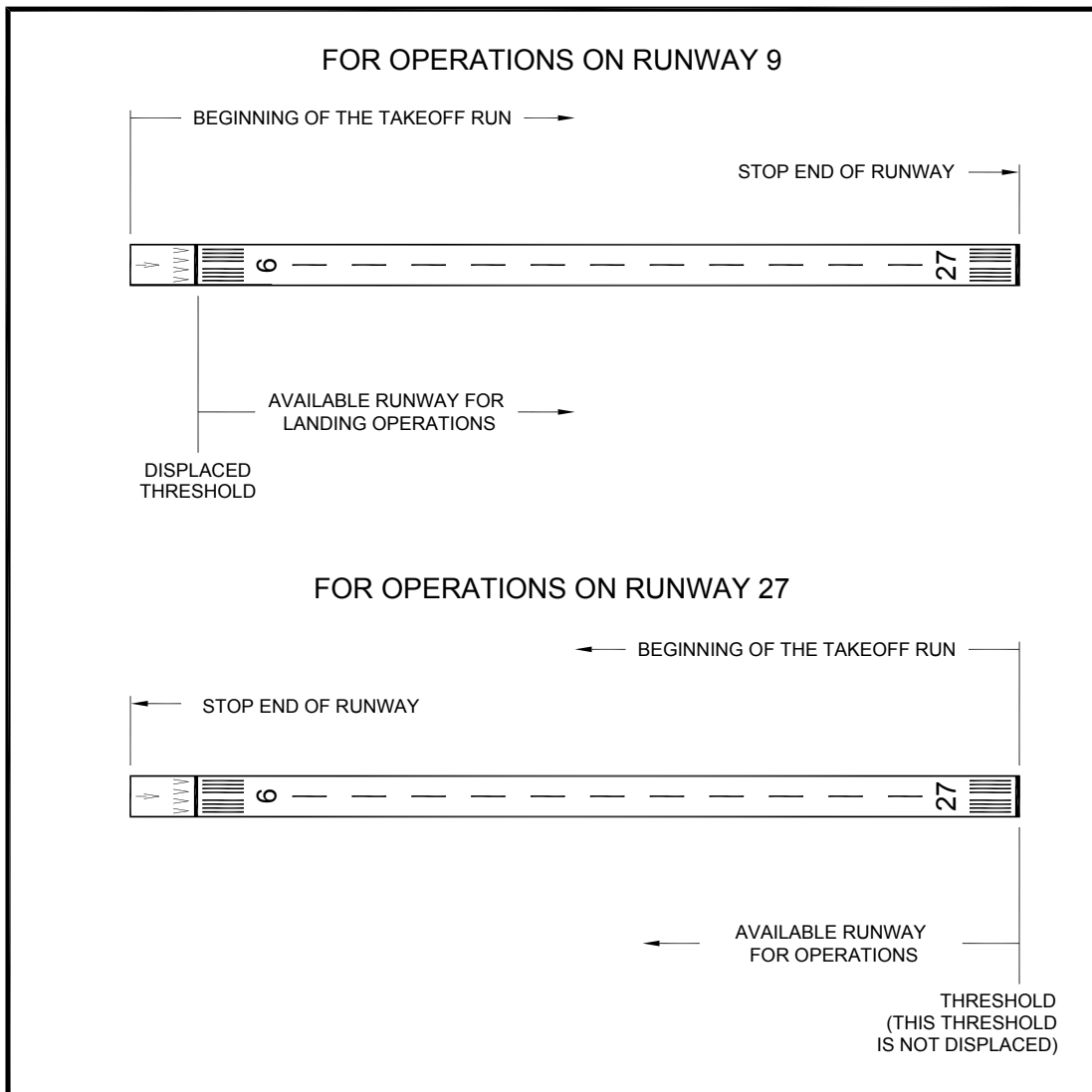
**m. FAA-operated Airport Traffic Control Tower (ATCT).** Ensure unobstructed view from the tower cab is provided to all runway ends and approaches in accordance with Order 6480.4. For new airport construction, an ATCT is sited per Order 6480.4. See paragraph 206 for more information.

**303. Runway end siting requirements.**

This paragraph provides guidance on the preliminary design for the establishment of runway thresholds and departure ends. Final design must be based on a detailed analysis considering the requirements of Order 8260.3, United States Standard for Terminal Instrument Procedures (TERPS).

**a. Introduction.**

**(1) Runway Ends.** The runway ends are the physical ends of the rectangular surface that constitutes a runway. The end of the runway is normally the beginning of the takeoff roll and the end of the landing roll out. (See Figure 3-1).



**Notes:**

1. For runway marking standards, see AC 150/5340-1.
2. For runway lighting standards, see AC 150/5340-30.

**Figure 3-1. Runway ends**

**(2) Threshold.** The threshold is ideally located at the beginning of the runway. The threshold is located to provide proper clearance for landing aircraft over existing obstacles while on approach to landing. When an object beyond the airport owner's power to remove, relocate, or lower obstructs the airspace required for aircraft to land at the beginning of the runway for takeoff, the threshold may be located farther down the runway. Such a threshold is called a "displaced threshold." Thresholds can also be displaced to provide:

(a) A means for obtaining additional RSA prior to the threshold. See paragraph 307.

(b) A means for obtaining additional ROFA prior to the threshold. See paragraph 309.

(c) A means for locating the RPZ to mitigate unacceptable incompatible land uses. See paragraph 310.

(d) Mitigation of environmental impacts, including noise impacts.

Displacement of a threshold reduces the length of runway available for landings. The portion of the runway behind a displaced threshold may be available for takeoffs and, depending on the reason for displacement, may be available for takeoffs and landings from the opposite direction. Refer to paragraph 322 for additional information.

Displacement of the threshold often introduces disruptions to an otherwise orderly airport design. Approach light systems and NAVAIDs used for landing need to be moved. Taxiways that remain in the new approach area (prior to the threshold) can create situations where taxiing aircraft penetrate the approach surface or the Precision Obstacle Free Zone (POFZ) (see paragraph 308.d), and may be considered end-around taxiways (see paragraph 102.hh). Holdlines (see paragraph 315) may also need to be moved to keep aircraft clear of these areas and runway capacity may be affected. While threshold displacement is often used to as a solution for constrained airspace, airport designers need to carefully weigh the trade-offs of a displaced threshold. Displacing a threshold may also create a situation where the holdline must be placed on the parallel taxiway. This is undesirable as pilots do not normally expect to encounter a holdline on the parallel taxiway.

This guidance should not be interpreted as an FAA endorsement of the option to displace a runway threshold. Threshold displacement should be undertaken only after a full evaluation reveals that displacement is the best alternative. These standards minimize the loss of operational use of the established runway and reflect the FAA policy of maximum utilization and retention of existing paved areas on airports

**(3) Stop End of the Runway.** The stop end of the runway normally marks the end of the full-strength runway pavement available and suitable for departure.

**(4) Establishing and Protecting Runway Ends.** Runway ends are established whenever an existing runway is extended or shortened, thresholds are moved or displaced, or a new runway is constructed. When establishing runway ends:

(a) All TERPS approach surfaces and approach surfaces in Table 3-4 associated with the threshold should be clear of obstacles.

(b) The 40:1 instrument departure surface associated with the ends of designated instrument departure runways (see paragraph 102.vv) should be clear of obstacles. The FAA recommends the 40:1 departure surface be clear at all other departure ends. When it is not possible to keep the departure surface clear of obstacles, any obstacles must be evaluated through the Obstruction Evaluation/Airport Airspace Analysis (OE/AAA) process. See Figure 3-4.

(c) RSA and RPZ standards must be met.

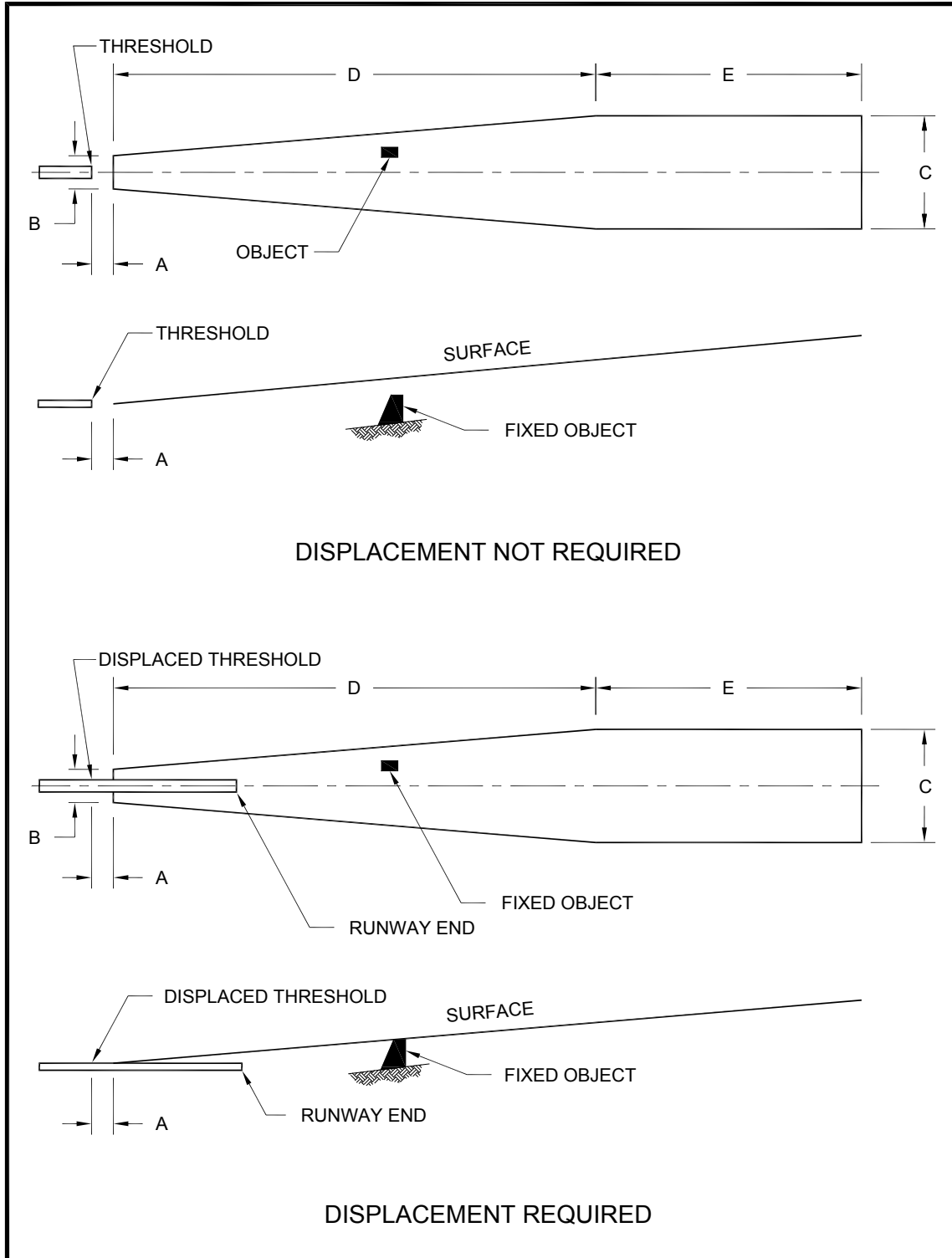
(d) To the extent practicable, ensure protection of runway ends from proposed development or natural vegetation growth that could penetrate either the approach or departure surfaces. Protection is provided through land use restrictions and zoning easements or acquisitions (see AC 150/5020-1).

(e) Consider other surfaces associated with electronic and visual NAVAIDs such as a Visual Glideslope Indicator (VGSI), ALS, or Instrument Landing System (ILS).

**b. Approach surfaces.** The approach surfaces defined in this paragraph are not the approach surfaces defined in Part 77.

(1) **General.** Approach surfaces are designed to protect the use of the runway in both visual and instrument meteorological conditions near the airport. The approach surface typically has a trapezoidal shape that extends away from the runway along the centerline at a specific slope, expressed in horizontal feet by vertical feet, with a starting point at the runway threshold elevation (see Figure 3-2, note 2). For example, a 20:1 slope rises one unit vertically for every 20 units horizontally. The specific size, slope and starting point of the trapezoid depends upon the visibility minimums and the type of procedure associated with the runway end. See Figure 3-2, paragraph 306, and Table 3-2. If necessary to avoid obstacles, the approach surface may be offset as shown in Figure 3-3.

(2) **Threshold Establishment.** Position the threshold so that there are no obstacle penetrations to the appropriate approach surface specified in Table 3-2 and that RSA and RPZ standards are met. Airport designers should consider the ultimate approach visibility minimums planned for the runway when establishing the threshold. For example, a threshold positioned to meet visual approach surface requirements may not allow for the future implementation of an IAP because of penetrations to the instrument approach surfaces.



- Notes:**
1. See [Table 3-2](#) for dimensional data.
  2. The starting elevation of the approach slope begins at the elevation of the runway threshold. For displaced thresholds, the approach slope begins at the runway elevation at the displaced threshold.

**Figure 3-2. Threshold siting based on approach slope**

**Table 3-2. Approach/departure standards table**

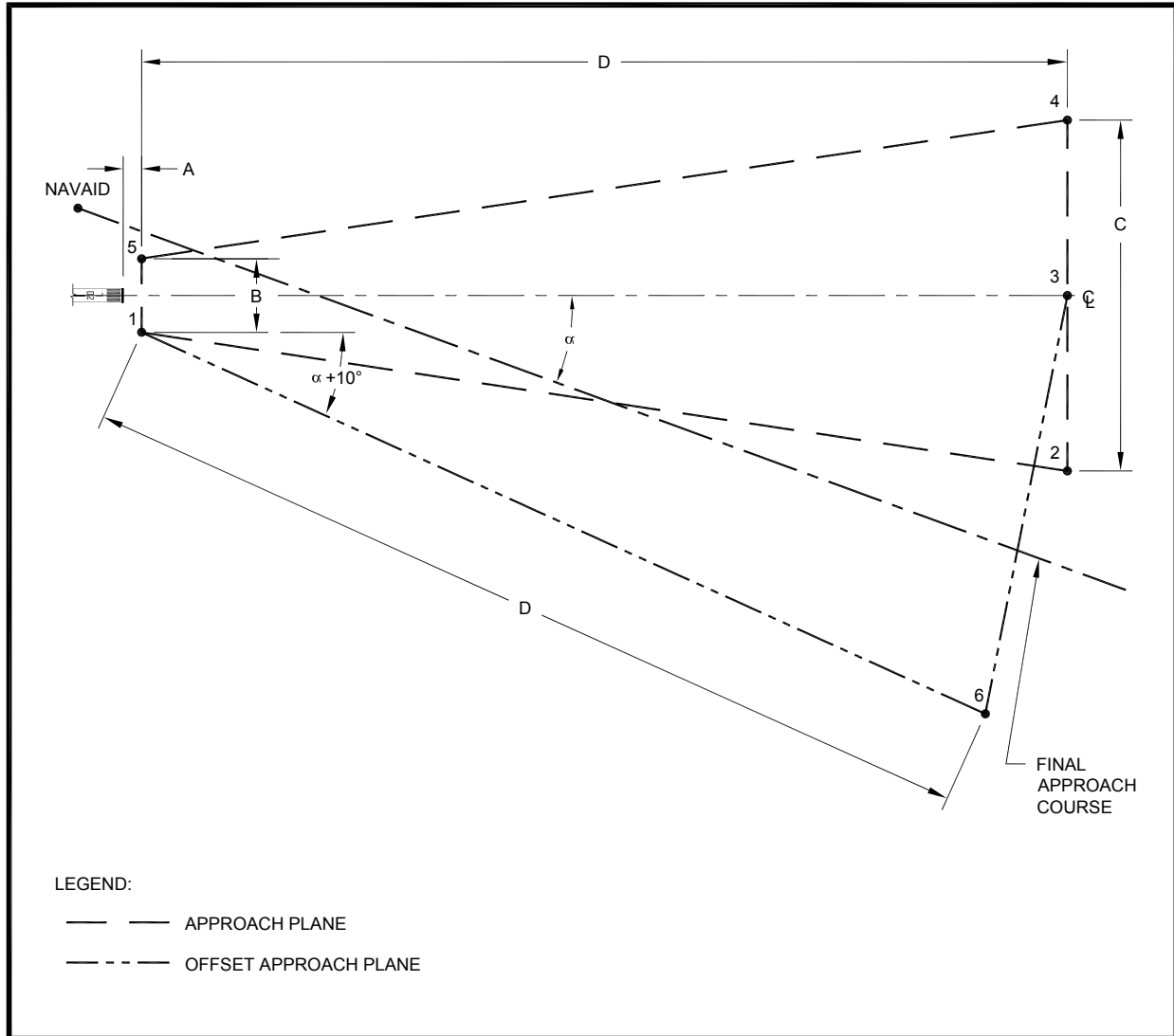
Runway Type		DIMENSIONAL STANDARDS*					Slope/ OCS
		Feet (Meters)					
		A	B	C	D	E	
1	Approach end of runways expected to serve small airplanes with approach speeds less than 50 knots. (Visual runways only, day/night)	0 (0)	120 (37)	300 (91)	500 (152)	2,500 (762)	15:1
2	Approach end of runways expected to serve small airplanes with approach speeds of 50 knots or more. (Visual runways only, day/night)	0 (0)	250 (76)	700 (213)	2,250 (686)	2,750 (838)	20:1
3	Approach end of runways expected to serve large airplanes (Visual day/night); or instrument minimums $\geq$ 1 statute mile (1.6 km) (day only).	0 (0)	400 (122)	1000 (305)	1,500 (457)	8,500 (2591)	20:1
4	Approach end of runways expected to support instrument night operations, serving approach Category A and B aircraft only. <sup>1</sup>	200 (61)	400 (122)	3,800 (1158)	10,000 <sup>2</sup> (3048)	0 (0)	20:1
5	Approach end of runways expected to support instrument night operations serving greater than approach Category B aircraft. <sup>1</sup>	200 (61)	800 (244)	3,800 (1158)	10,000 <sup>2</sup> (3048)	0 (0)	20:1
6	Approach end of runways expected to accommodate instrument approaches having visibility minimums $\geq$ 3/4 but $<$ 1 statute mile ( $\geq$ 1.2 km but $<$ 1.6 km), day or night.	200 (61)	800 (244)	3,800 (1158)	10,000 <sup>2</sup> (3048)	0 (0)	20:1
7	Approach end of runways expected to accommodate instrument approaches having visibility minimums $<$ 3/4 statute mile (1.2 km).	200 (61)	800 (244)	3,800 (1158)	10,000 <sup>2</sup> (3048)	0 (0)	34:1
8 <sup>3,5,6,7</sup>	Approach end of runways expected to accommodate approaches with vertical guidance (Glide Path Qualification Surface [GQS]).	0 (0)	Runway width + 200 (61)	1520 (463)	10,000 <sup>2</sup> (3048)	0 (0)	30:1
9	Departure runway ends for all instrument operations.	0 <sup>4</sup> (0)	See <a href="#">Figure 3-4</a> .				40:1

\* The letters are keyed to those shown in [Figure 3-2](#).

**Notes:**

1. Marking and lighting of obstacle penetrations to this surface or the use of a Visual Guidance Slope Indicator (VGSI), as defined by [Order 8260.3](#), may avoid displacing the threshold.
2. 10,000 feet (3048 m) is a nominal value for planning purposes. The actual length of these areas is dependent upon the visual descent point position for 20:1 and 34:1, and DA point for the 30:1.
3. When objects exceed the height of the GQS, an approach with vertical guidance is not authorized. Refer to [Table 3-4](#) and its footnote 4 for further information on GQS.
4. Dimension A is measured relative to TODA (to include clearway).
5. Surface dimensions / OCS slope represent a nominal approach with 3 degree Glide Path Angle (GPA), 50 feet (15 m) TCH,  $<$  500 feet (152 m) HATH. For specific cases, refer to [Order 8260.3](#). The OCS slope (30:1) supports a nominal approach of 3 degrees (also known as the GPA). This assumes a TCH of 50 feet (15 m). Three degrees is commonly used for ILS systems and VGSI aiming angles. This approximates a 30:1 approach slope that is between the 34:1 and the 20:1 approach surfaces of [Part 77](#). Surfaces cleared to 34:1 should accommodate a 30:1 approach without any obstacle clearance problems.
6. For runways with vertically guided approaches the criteria in row 8 is in addition to the basic criteria established within the table, to ensure the protection of the GQS.
7. For planning purposes, determine a tentative DA based on a 3 degree GPA and a 50-foot (15 m) TCH.





**Notes:**

1. Refer to Table 3-2 for all applicable dimensional standards and slopes.
2. To determine offset approach plane:
  - a. Construct the approach trapezoid for the runway type in Table 3-2 locating points 1, 2, 3, 4, and 5.
  - b. Point 1 is located at distance "A" from the runway threshold and distance 1/2 "B" from the runway centerline in the direction of the offset ( $\alpha$ ).
  - c. From point 1, extend line at an angle ( $\alpha + 10^\circ$ ) a distance "D" locating point 6.
  - d. Connect point 6 to point 3.
  - e. The offset area is defined by the perimeter 1-6-3-4-5-1.
  - f.  $\alpha$  = angle of the offset final approach (angle formed by the intersection of the offset final approach course with the extended runway CL).

**Figure 3-3. Approach slopes – with offset approach course**

**(3) Approach Procedures.** Once a threshold is established with the appropriate approach surface, the airport operator files a request with the FAA’s Aeronautical Navigation Products ([www.faa.gov/air\\_traffic/flight\\_info/aeronav](http://www.faa.gov/air_traffic/flight_info/aeronav)). The FAA designs the procedure, performs a flight check, and then publishes the procedure for pilots. When approach

surfaces are entirely clear of obstacles, the resulting procedure will provide the optimum and most versatile situation for the pilot. Otherwise, a special mitigation measure may need to be added to the approach design to provide an equivalent level of safety. Mitigation measures are determined on a case-by-case basis, and may include, but not be limited to, the following:

- (a) Higher instrument landing minimums;
- (b) Higher than normal Glide Path Angles (GPAs);
- (c) Non-standard Threshold Crossing Heights (TCHs); and
- (d) Final approach offset.

Therefore, it is important to continue to protect instrument approaches from proposed development and the natural vegetation growth.

**c. Departure surfaces.**

(1) General. Departure surfaces, when clear, allow pilots to follow standard departure procedures. Where declared distances are not being reported, the departure surface elevation starts at the Departure End of Runway (DER) elevation. DER is also referred to as the stop end of runway. See Figure 3-4. Except for runways that have a designated clearway, the departure surface is a trapezoidal shape that begins at the end of the Takeoff Distance Available (TODA) (see paragraph 322) and extends along the extended runway centerline and with a slope, starting at the elevation of the end of the TODA, of 1 unit vertically for every 40 units horizontally (40:1). For runways that have a clearway, the departure surface begins at the far end of the clearway at the elevation of the clearway at that point. Figure 3-4 provides more information of the size, shape and orientation of the departure surface.

(2) Departure Procedures. Obstacles frequently penetrate the departure surface. These procedures may require:

- (a) Non-standard climb rates, and/or
- (b) Non-standard (higher) departure minimums. Therefore, it is important for airports to identify and remove these obstacles whenever possible when takeoff procedures can be enhanced, and also to prevent new obstacles.
- (c) Reduction in the length of the TODA.

(3) Threshold and Departure Surface Protection. Paragraph 306 provides guidance for acquiring property interest as necessary to protect approach and departure surfaces. Proposed development on land not owned by the airport is studied under Part 77. This regulation requires proponents to notify FAA of plans to construct an object that might penetrate a Part 77 surface and provides for FAA to conduct a study to determine if the proposal would constitute a hazard to air navigation if it were constructed. Note that the FAA determinations are advisory and do not prevent construction of hazards. See also AC 150/5020-1.

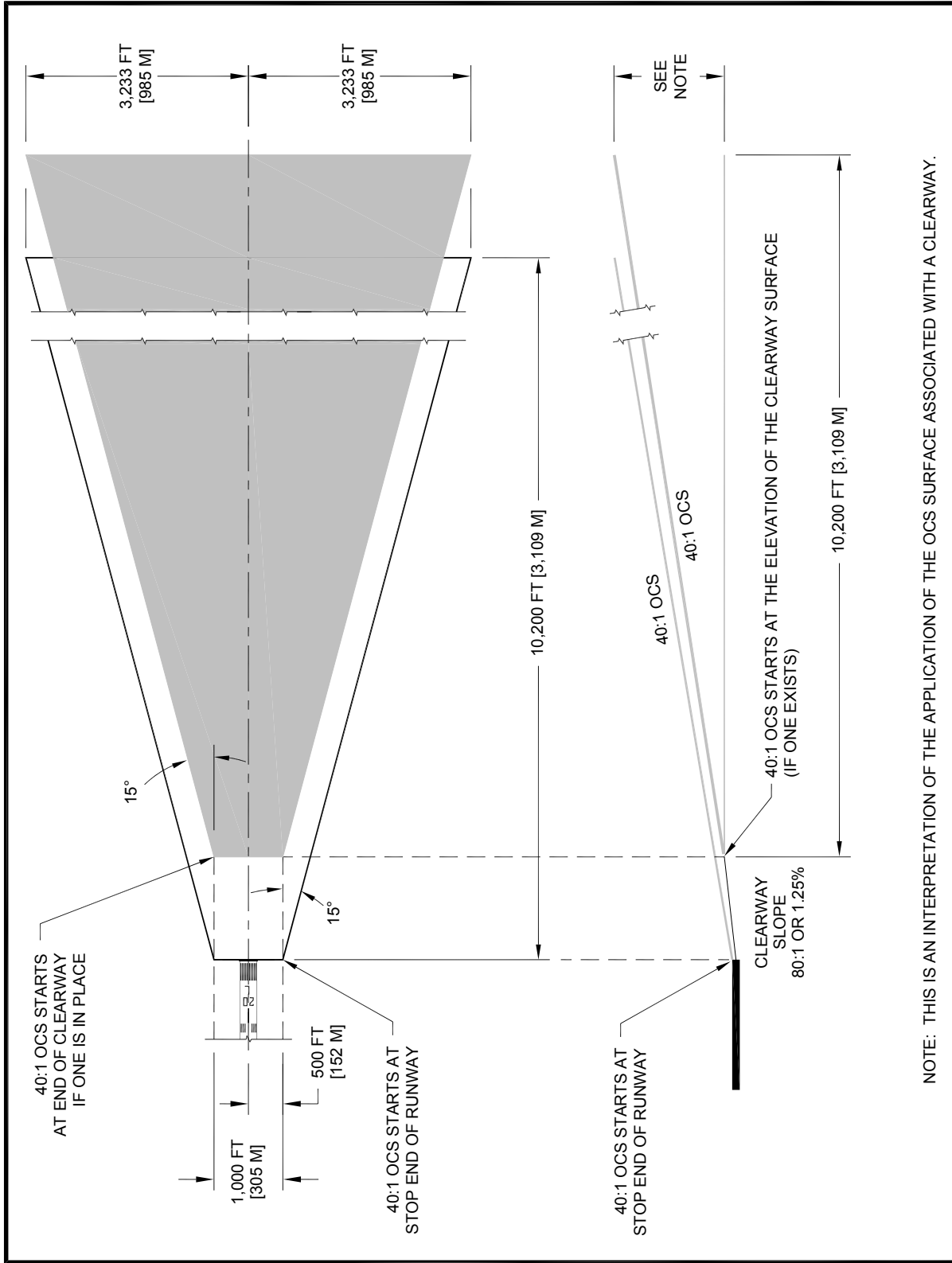


Figure 3-4. Departure surface for instrument runways (40:1)

### 304. Runway geometry.

a. **Runway length.** AC 150/5325-4 and aircraft flight manuals provide guidance on runway lengths for airport design, including declared distance lengths. The following factors are some that should be evaluated when determining a runway length:

- (1) Airport elevation.
- (2) Local prevailing surface wind and surface temperature.
- (3) Runway surface conditions and slope.
- (4) Performance characteristics and operating weight of aircraft.

b. **Runway width.** Interactive Table 3-5 presents runway width standards based on Runway Design Code (RDC) and approach visibility minimums.

c. **Runway shoulders.** Runway shoulders provide resistance to blast erosion and accommodate the passage of maintenance and emergency equipment and the occasional passage of an aircraft veering from the runway. Interactive Table 3-5 presents runway shoulder width standards. A stabilized surface, such as turf, normally reduces the possibility of soil erosion and engine ingestion of foreign objects. Soil not suitable for turf establishment requires a stabilized or low cost paved surface (see AC 150/5320-6). Paved shoulders are required for runways accommodating Airplane Design Group (ADG) IV and higher aircraft, and are recommended for runways accommodating ADG-III aircraft. Turf, aggregate-turf, soil cement, lime or bituminous stabilized soil are recommended adjacent to runways accommodating ADG-I and ADG-II aircraft.

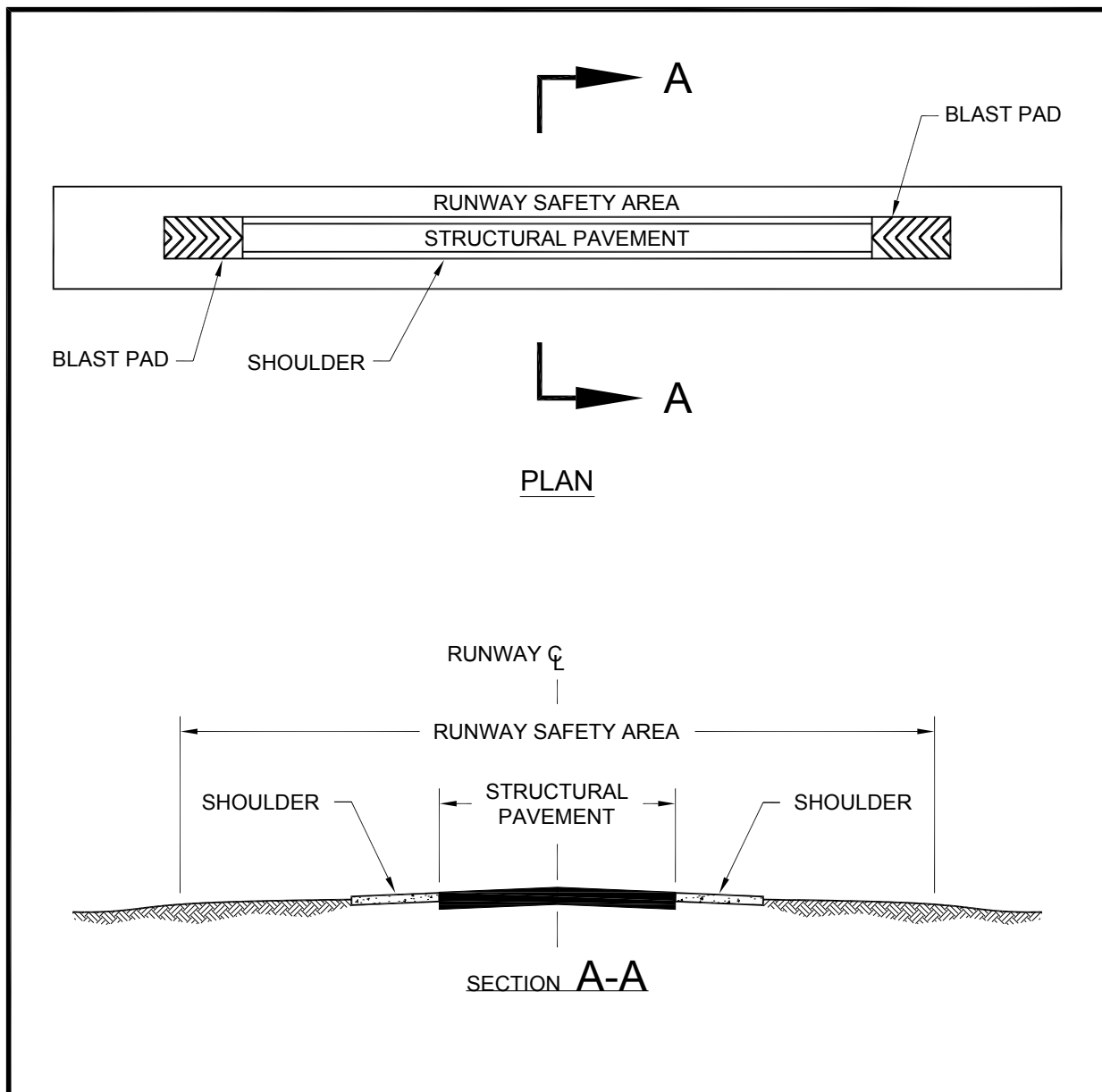
For further discussion regarding jet blast, refer to Appendix 3. Figure 3-23 and Figure 4-33 depict runway shoulders.

d. **Runway blast pads.** Blast pads are always paved. Paved runway blast pads provide blast erosion protection beyond runway ends during jet aircraft operations. Interactive Table 3-5 contains the standard length and width for blast pads for takeoff operations requiring blast erosion control. Refer to Appendix 3 for further discussion. Figure 3-5, above, depicts runway blast pads. For blast pads, follow the same longitudinal and transverse grades as the respective grades of the associated safety area. Blast pads are not stopways, though a stopway may also serve as a blast pad.

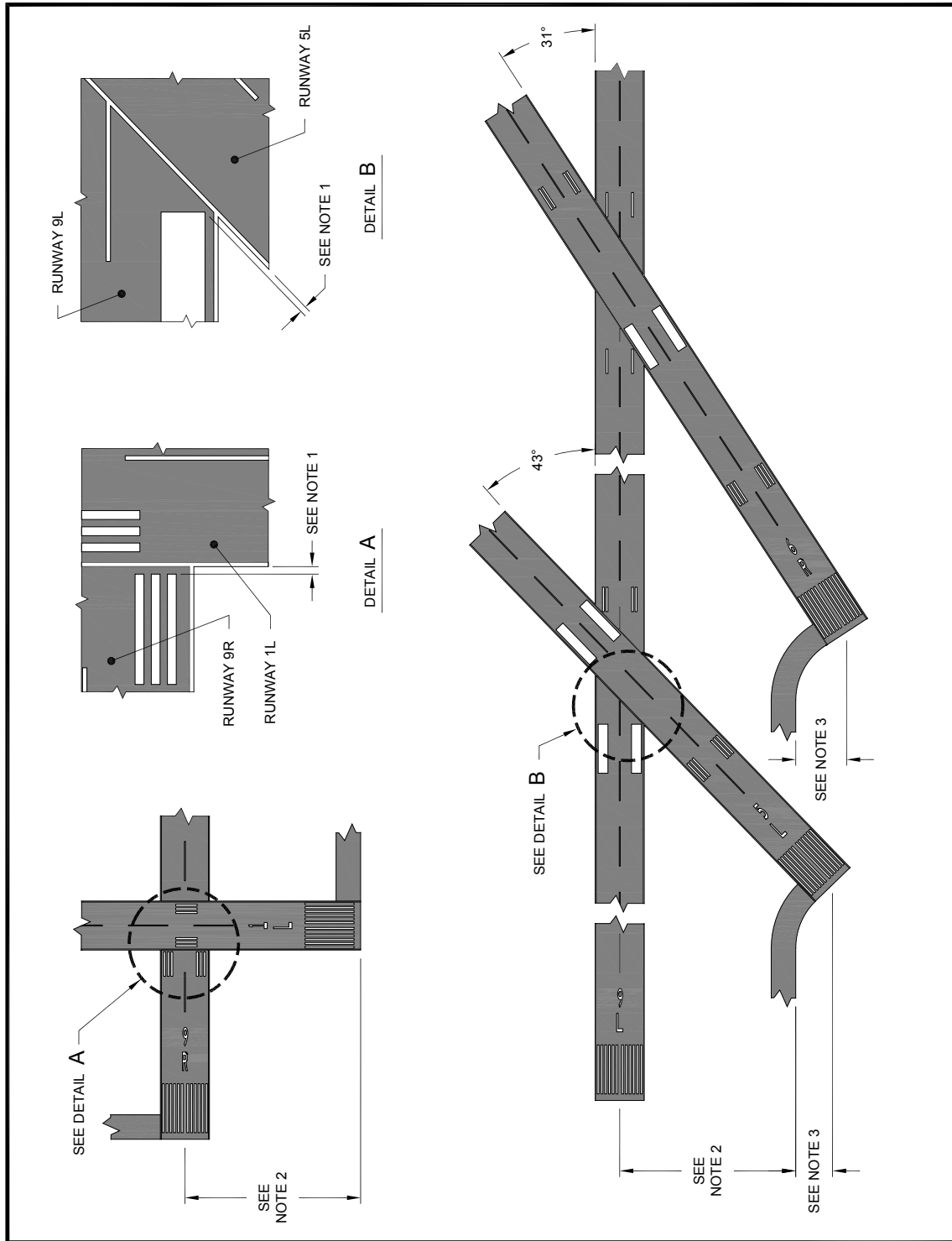
e. **Non-intersecting runways.** Runway separation must take into account the full dimensional requirements of the safety areas of the runway and taxiway systems on the airport. If possible, safety areas should not overlap, since work in the overlapping area would affect both runways. In addition, operations on one runway may violate the critical area of a NAVAID on the other runway. This condition should exist only at existing constrained airports where non-overlapping safety areas are impracticable. Configurations where runway thresholds are close together should be avoided, as they can be confusing to pilots, resulting in wrong-runway takeoffs. If the RSA of one runway overlaps onto the full strength pavement of a second runway or taxiway, the chance of runway/taxiway incursion incident is increased. The angle between the

extended runway centerlines should not be less than 30 degrees. This configuration will minimize the possibility of confusing marking and lighting schemes being used to identify the limits of the safety area that overlaps onto runway or taxiway pavement.

**f. Intersecting runways.** The pilot must have clear and understandable pavement markings for landing. When two runways intersect, it may be necessary to adjust pavement markings as specified in AC 150/5340-1. If possible, however, runway intersections should be designed to avoid the need to adjust aiming point markings and/or remove touchdown zone markings. It is possible to locate the intersection between two precision instrument runways at an angle of as little as 33 degrees while maintaining standard markings. See Figure 3-6.



**Figure 3-5. Runway Safety Area (RSA)**



**Notes:**

1. Markings are for illustration purposes only; see [AC 150/5340-1](#) for details.
2. Minimum distance: required runway centerline to taxiway centerline separation plus 1/2 taxiway width.
3. Distance varies per taxiway curve radius.

**Figure 3-6. Intersecting runways**

**305. Runway line of sight requirements.**

**a. Purpose.** The runway line of sight requirements facilitate coordination among aircraft, and between aircraft and vehicles that are operating on active runways. This allows departing and arriving aircraft to verify the location and actions of other aircraft and vehicles on the ground that could create a conflict.

**b. Line of sight standards along individual runways.**

**(1)** Runways without Full Parallel Taxiways. Any point 5 feet (1.5 m) above the runway centerline must be mutually visible with any other point 5 feet (1.5 m) above the runway centerline.

**(2)** Runways with a Full Parallel Taxiway. Any point 5 feet (1.5 m) above the runway centerline must be mutually visible with any other point 5 feet (1.5 m) above the runway centerline that is located at a distance that is less than one half the length of the runway.

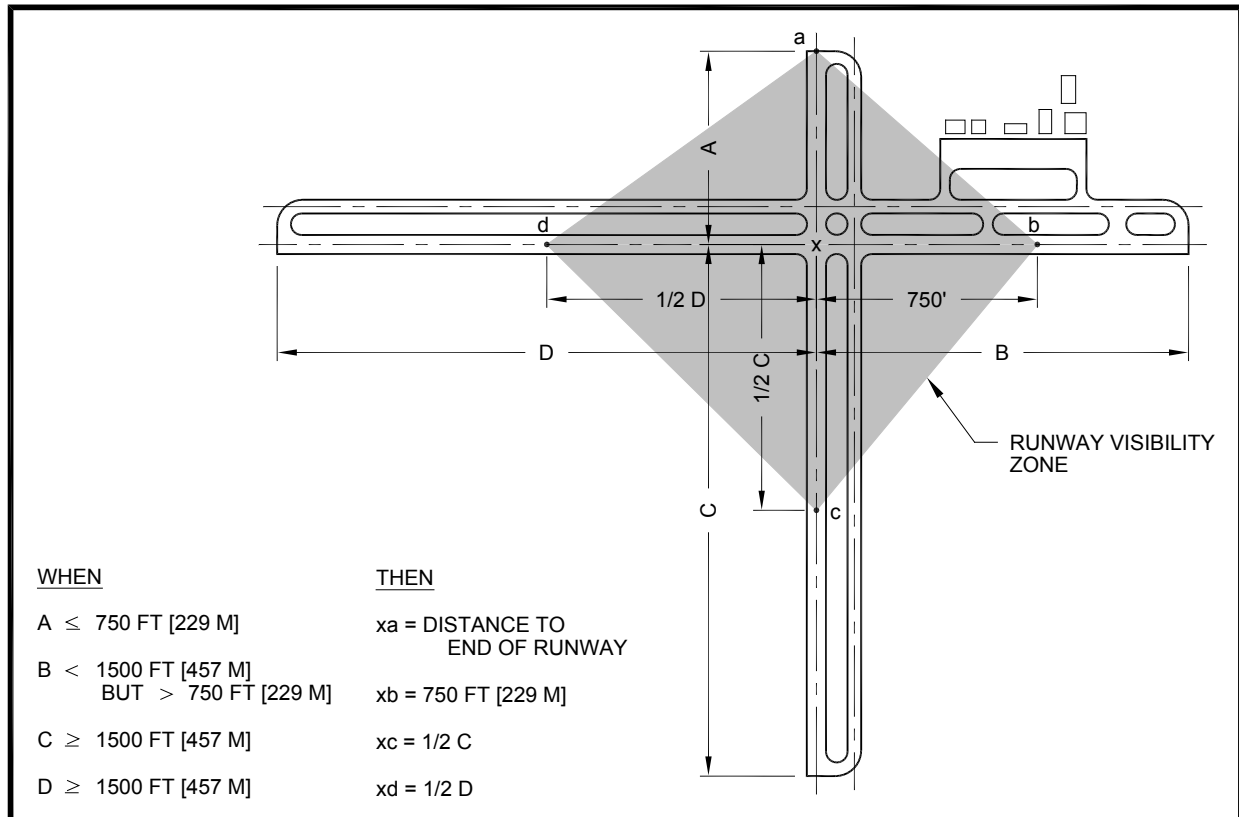
**c. Line of sight standards between intersecting runways.** Any point 5 feet (1.5 m) above runway centerline and in the runway visibility zone ([Figure 3-7](#)) must be mutually visible with any other point 5 feet (1.5 m) above the centerline of the crossing runway and inside the runway visibility zone. The runway visibility zone is defined as an area formed by imaginary lines connecting the two runways' line of sight points. Locate the runway line of sight points as follows:

**(1)** The end of the runway if runway end is located within 750 feet (229 m) of the crossing runway centerline or extension.

**(2)** A point 750 feet (229 m) from the runway intersection (or extension) if the end of the runway is located within 1,500 feet (457 m) of the crossing runway centerline or extension.

**(3)** A point one-half of the distance from the intersecting runway centerline (or extension), if the end of the runway is located at least 1,500 feet (457 m) from the crossing runway centerline or extension.

**d. Modifications.** A modification to this standard may be approved by the FAA if an acceptable level of safety is maintained, because: (1) the airport has a 24-hour control tower; and (2) the operation of the control tower will continue based on acceptable activity forecasts.



**Figure 3-7. Runway visibility zone**

### 306. Object clearing.

Safe and efficient landing and takeoff operations at an airport require that certain areas on and near the airport are clear of objects or restricted to objects with a certain function, composition, and/or height.<sup>1</sup> These clearing standards and criteria are established to create a safer environment for the aircraft operating on or near the airport. The airport operator is not required to prevent or clear penetrations to the Part 77, Subpart C, imaginary surfaces when the FAA determines these penetrations are not hazards. However, any existing or proposed object, whether man-made or of natural growth that penetrates these surfaces is classified as an “obstruction” and is presumed to be a hazard to air navigation. These obstructions are subject to an FAA aeronautical study, after which the FAA issues a determination stating whether the obstruction is in fact considered a hazard. The airport operator must conduct a detailed analysis considering the requirements of Order 8260.3, United States Standard for Terminal Instrument Procedures (TERPS), to ensure all applicable surfaces are captured.

<sup>1</sup> The heights of traverse ways are adjusted as explained in 14 CFR Part 77, paragraph 77.9(c): “Any highway, railroad, or other traverse way for mobile objects, [is] adjusted upward 17 feet for an Interstate Highway that is part of the National System of Military and Interstate Highways where overcrossings are designed for a minimum of 17 feet vertical distance, 15 feet for any other public roadway, 10 feet or the height of the highest mobile object that would normally traverse the road, whichever is greater, for a private road, 23 feet for a railroad, and for a waterway or any other traverse way not previously mentioned, an amount equal to the height of the highest mobile object that would normally traverse it...”



- a. **ROFA.** ROFAs require clearing of objects as specified in paragraph 309.
- b. **RSA.** RSAs require clearing of objects, except for objects that need to be located in the RSA because of their function as specified in paragraph 307.
- c. **OFZ.** OFZs require clearing of object penetrations including aircraft fuselages and tails. Frangible NAVAIDs that need to be located in the OFZ because of their function are exempted from this standard. Paragraph 308 specifies OFZ standard dimensions.
- d. **Runway end establishment.** The runway end establishment OCSs are defined in paragraph 303 and Table 3-2. Clear penetrations or locate the runway end such that there are no penetrations.
- e. **NAVAIDs.** Certain NAVAIDs require clearing of an associated “critical area” for proper operation. These NAVAID critical areas are depicted in Chapter 6.
- f. **RPZ.** The RPZ clearing standards are specified in paragraph 310.
- g. **Marking and lighting.** The adverse effects on some obstructions that are not feasible to clear may be mitigated by lighting and marking. However, operational restrictions or higher minimums may be required, or it may not be possible to establish an IAP.

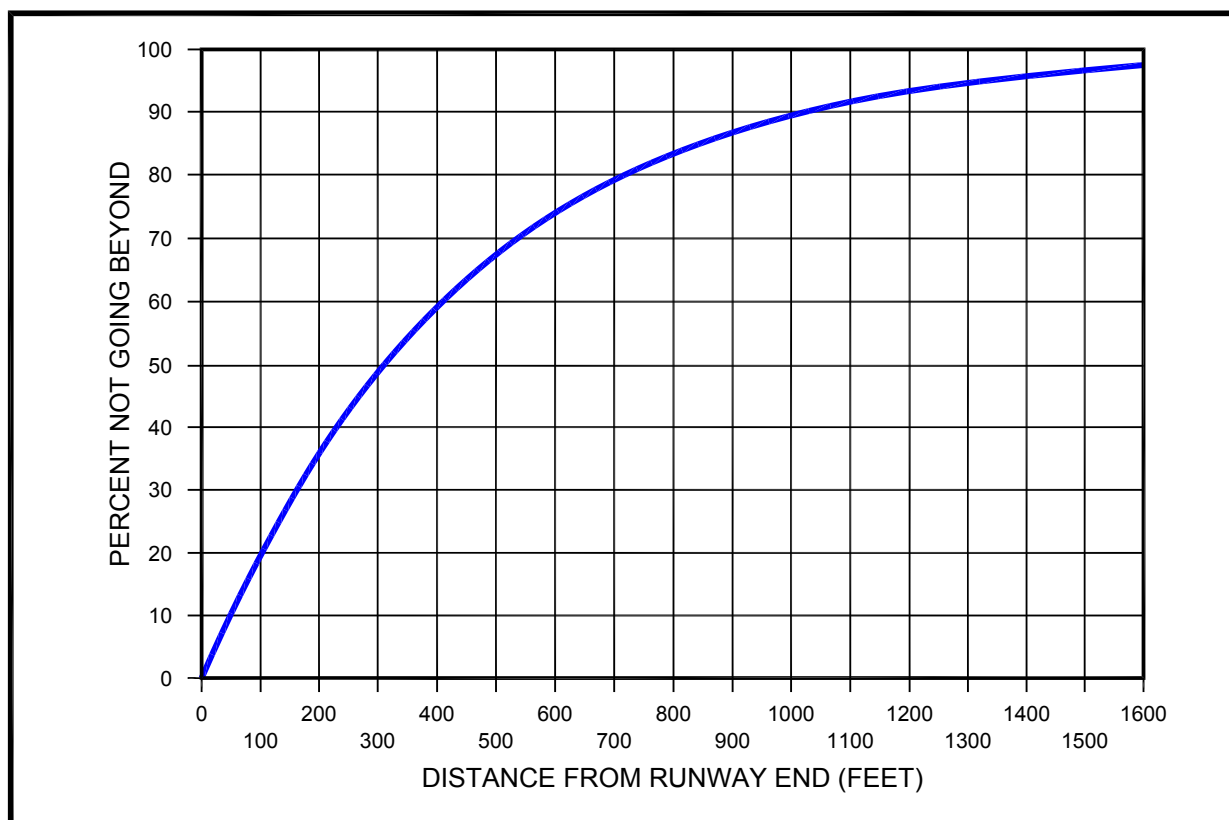
### **307. Runway Safety Area (RSA) / Engineered Materials Arresting Systems (EMAS).**

#### **a. RSA development.**

(1) **Historical Development.** In the early years of aviation, all aircraft operated from relatively unimproved airfields. As aviation developed, the alignment of takeoff and landing paths centered on a well-defined area known as a landing strip. Thereafter, the requirements of more advanced aircraft necessitated improving or paving the center portion of the landing strip. While the term “landing strip” was retained to describe the graded area surrounding and upon which the runway or improved surface was constructed, the primary role of the landing strip changed to that of a safety area surrounding the runway. This area had to be capable under normal (dry) conditions of supporting aircraft without causing structural damage to the aircraft or injury to their occupants. Later, the designation of the area was changed to “runway safety area” to reflect its functional role. The RSA enhances the safety of aircraft which undershoot, overrun, or veer off the runway, and it provides greater accessibility for fire-fighting and rescue equipment during such incidents. Figure 3-8 below depicts the approximate percentage of aircraft overrunning the runway which stay within a specified distance from the runway end. The current RSA standards are based on 90% of overruns being contained within the RSA. The RSA is depicted in Figure 3-5 and its dimensions are given in interactive Table 3-5.

(2) **Recent Changes.** FAA recognizes that incremental improvements inside full RSA dimensions can enhance the margin of safety for aircraft. This is a significant change from the earlier concept where the RSA was deemed to end at the point it was no longer graded and constructed to standards. Previously, a modification to standards could be issued if the actual, graded, and constructed RSA could not meet dimensional standards. Today,

modifications to standards no longer apply to RSAs. The airport owner and the FAA must continually analyze a non-standard RSA with respect to operational, environmental, and technological changes and revise the determination as appropriate. Incremental improvements are included in the determination if they are practicable and they will enhance the margin of safety. The concept of incremental improvement obviously precludes the placing of objects within the standard RSA dimensions even if that location does not fully meet RSA standards.



**Figure 3-8. Percent of aircraft overrun versus distance beyond the runway end**

**b. Design standards.** The RSA is centered on the runway centerline.

Interactive [Table 3-5](#) presents RSA dimensional standards. [Figure 3-5](#) depicts the RSA. EMAS, as discussed in paragraph [307.g](#), is an alternative that should be considered to mitigate overruns at airports when a full-dimension RSA is not practicable due to natural obstacles, local development, and/or environmental constraints. EMAS may also be used to maximize runway length. The RSA must be:

- (1) cleared and graded and have no potentially hazardous ruts, humps, depressions, or other surface variations;
- (2) drained by grading or storm sewers to prevent water accumulation;

(3) capable, under dry conditions, of supporting snow removal equipment, Aircraft Rescue and Fire Fighting (ARFF) equipment, and the occasional passage of aircraft without causing damage to the aircraft; and

(4) free of objects, except for objects that need to be located in the RSA because of their function. Objects higher than 3 inches (76 mm) above grade must be constructed, to the extent practical, on frangibly mounted structures of the lowest practical height with the frangible point no higher than 3 inches (76 mm) above grade. Other objects, such as manholes, should be constructed at grade and capable of supporting the loads noted above. In no case should their height exceed 3 inches (76 mm) above grade. See AC 150/5220-23.

**c. Construction standards.** Compaction of RSAs must comply with Specification P-152, Excavation, Subgrade and Embankment, found in AC 150/5370-10.

**d. RSA standards cannot be modified.** The standards remain in effect regardless of the presence of natural or man-made objects or surface conditions that preclude meeting full RSA standards. Facilities, including NAVAIDs, which would not normally be permitted in an RSA, should not be installed inside the full RSA dimensions even when the RSA does not meet standards in other respects. A continuous evaluation of all practicable alternatives for improving each sub-standard RSA is required until it meets all standards for grade, compaction, and object frangibility. Order 5200.8 explains the process for conducting this evaluation.

**e. Allowance for NAVAIDs.** The RSA is intended to enhance the margin of safety for landing or departing aircraft. Accordingly, the design of an RSA must account for NAVAIDs that might impact the effectiveness of the RSA:

(1) RSA grades sometimes require approach lights and localizers (LOCs) to be mounted on non-frangible towers that could create a hazard for aircraft and result in degraded LOC performance. Therefore, consider any practicable RSA construction to a less demanding grade than the standard grade to avoid the need for non-frangible structures.

(2) ILS facilities (Glideslopes [GSs] and LOCs) are not usually required to be located inside the RSA. However, they do require a graded area around the antenna. (See Chapter 6 for more information on the siting of ILS facilities.) RSA construction that ends abruptly in a precipitous drop-off can result in design proposals where the facility is located inside the RSA. Therefore, construct any practicable earthwork beyond the standard RSA dimensions necessary to accommodate ILS facilities when they are installed.

**f. RSA grades.** For longitudinal and transverse grades, see paragraph 313.d. Keeping negative grades to the minimum practicable contributes to the effectiveness of the RSA.

**g. EMAS.** A standard EMAS provides a level of safety that is equivalent to an RSA built to the dimensional standards in interactive Table 3-5. Hence, an RSA using a “standard EMAS” installation is considered to be a “standard RSA.” The term “standard RSA” was previously used to describe an RSA meeting full dimensional standards. Such an RSA is now referred to as a “full dimension RSA.”

(1) An EMAS is designed to stop an overrunning aircraft by exerting predictable deceleration forces on its landing gear as the EMAS material deforms. EMAS performance is dependent on aircraft weight, landing gear configuration, tire pressure, and entry speed.

(2) A “standard EMAS” installation will stop the design aircraft exiting the runway at 70 knots within an area that also provides the required protection for undershoots in the opposite direction, as specified in interactive [Table 3-5](#) (dimension P). [AC 150/5220-22](#) provides guidance on planning, design, installation and maintenance of EMAS in RSAs.

(3) Refer to [Order 5200.8](#) for the evaluation process and [Order 5200.9](#) to determine the best practical and financially feasible alternative.

### 308. Obstacle Free Zone (OFZ).

The OFZ clearing standard precludes aircraft and other object penetrations, except for frangible NAVAIDs that need to be located in the OFZ because of their function. The Runway OFZ (ROFZ) and, when applicable, the POFZ, the inner-approach OFZ, and the inner-transitional OFZ compose the OFZ. The OFZ is a design surface but is also an operational surface and must be kept clear during operations. Its shape is dependent on the approach minimums for the runway end and the aircraft on approach, and thus, the OFZ for a particular operation may not be the same shape as that used for design purposes. As such, the modification to standards process does not apply to the OFZ. Procedures to protect the OFZ during operations by aircraft/operations more demanding than used for the design of the runway are beyond the scope of this AC. The need for such special procedures can be avoided by using the most demanding anticipated operations in selecting the OFZ used for runway design. [Figure 3-9](#), [Figure 3-10](#), [Figure 3-11](#), [Figure 3-12](#), and [Figure 3-13](#) show the OFZ.

**a. Runway Obstacle Free Zone (ROFZ).** The ROFZ is a defined volume of airspace centered above the runway centerline, above a surface whose elevation at any point is the same as the elevation of the nearest point on the runway centerline. The ROFZ extends 200 feet (61 m) beyond each end of the runway. Its width is as follows:

- (1) For operations by small aircraft:
  - (a) 300 feet (91 m) for runways with lower than 3/4 statute mile (1.2 km) approach visibility minimums.
  - (b) 250 feet (76 m) for operations on other runways by small aircraft with approach speeds of 50 knots or more.
  - (c) 120 feet (37 m) for operations on other runways by small aircraft with approach speeds of less than 50 knots.

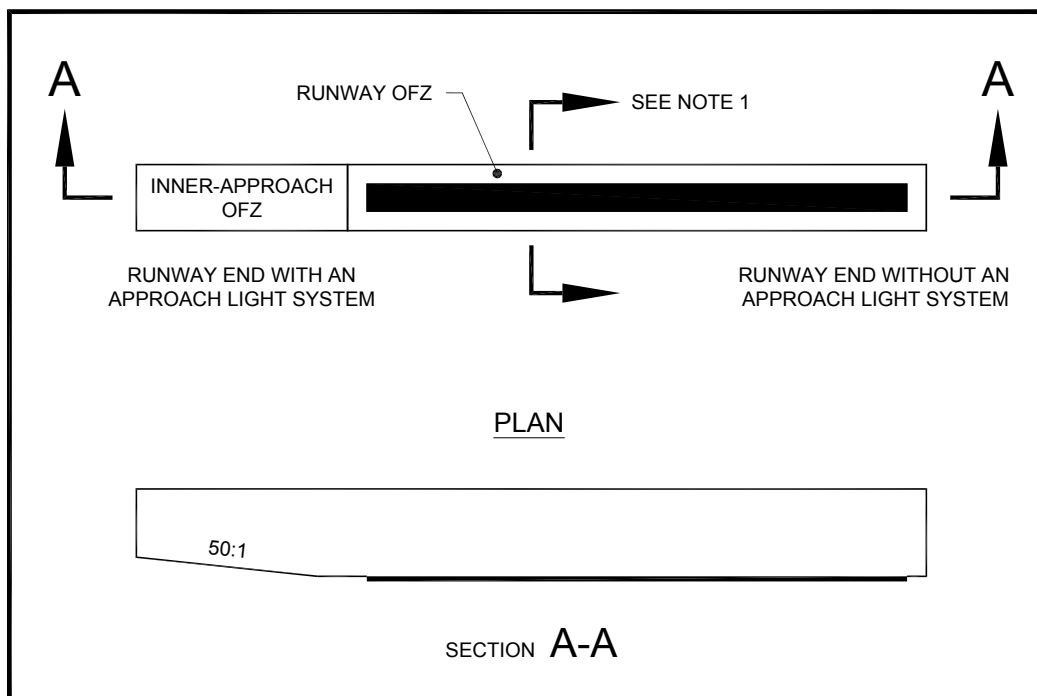
- (2) 400 feet (122 m) for operations by large aircraft.

**b. Inner-approach OFZ.** The inner-approach OFZ is a defined volume of airspace centered on the approach area. It applies only to runways with an ALS. The inner-approach

OFZ begins 200 feet (61 m) from the runway threshold at the same elevation as the runway threshold and extends 200 feet (61 m) beyond the last light unit in the ALS. Its width is the same as the ROFZ and rises at a slope of 50 (horizontal) to 1 (vertical) from its beginning.

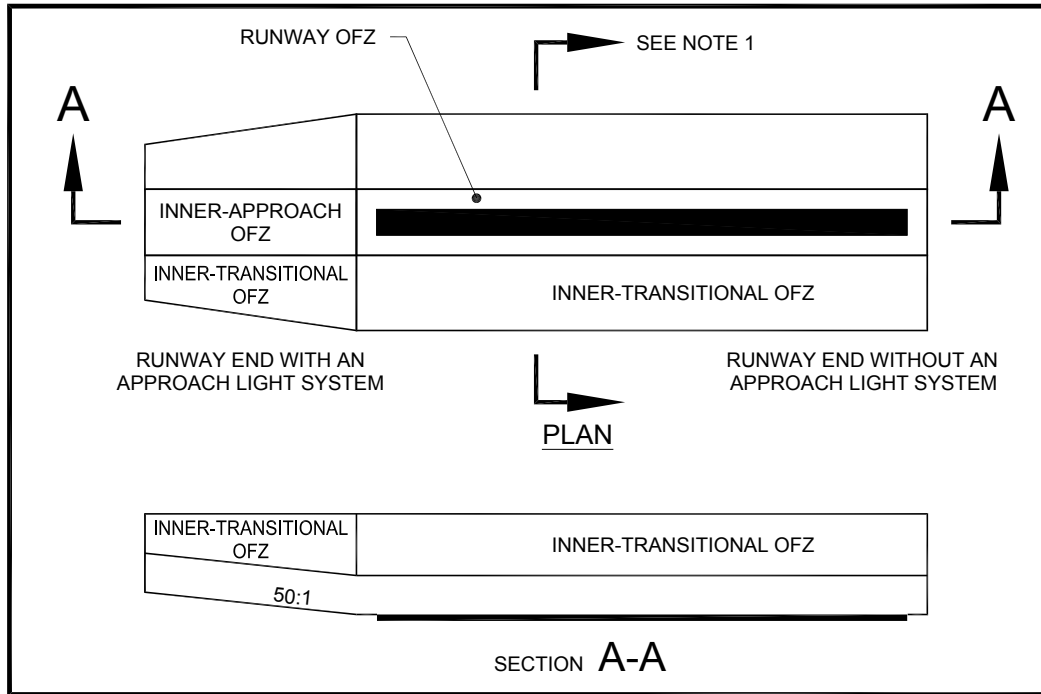
**c. Inner-transitional OFZ.** The inner-transitional OFZ is a defined volume of airspace along the sides of the ROFZ and inner-approach OFZ. It applies only to runways with lower than 3/4 statute mile (1.2 km) approach visibility minimums. Aircraft tails may not violate the inner-transitional OFZ. Runway to taxiway separation may need to be increased, but may not be decreased, based on this requirement.

**(1)** For operations on runways by small aircraft, the inner-transitional OFZ slopes 3 (horizontal) to 1 (vertical) out from the edges of the ROFZ and inner-approach OFZ to a height of 150 feet (46 m) above the established airport elevation.



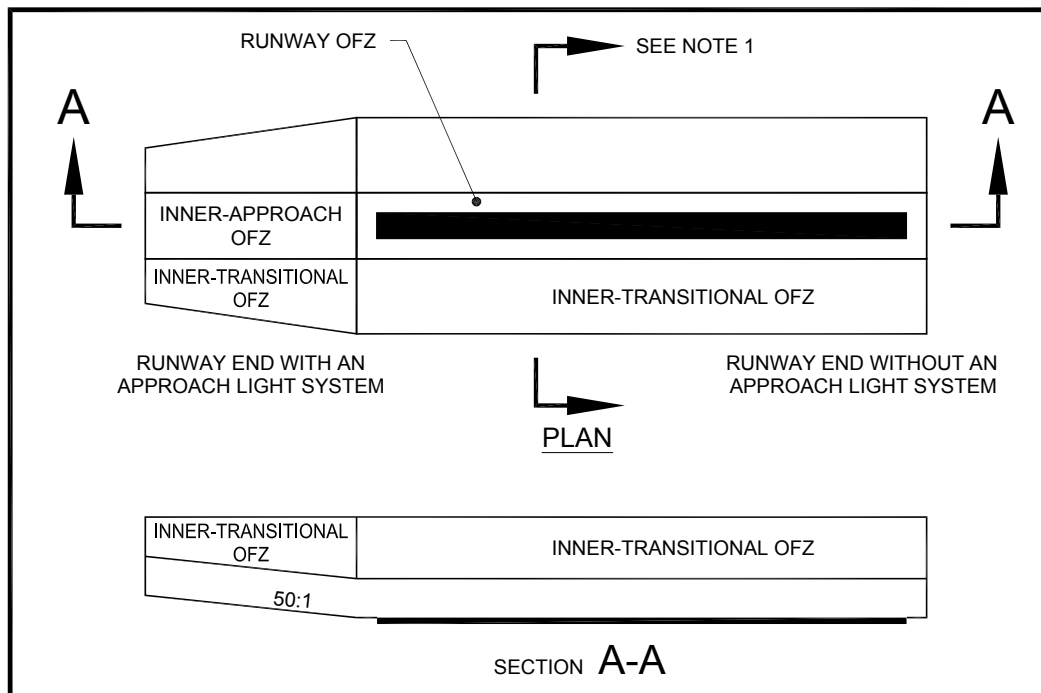
**Note:** 1. See [Figure 3-13](#) for this view.

**Figure 3-9. Obstacle Free Zone (OFZ) for visual runways and runways with not lower than 3/4 statute mile (1.2 km) approach visibility minimums**



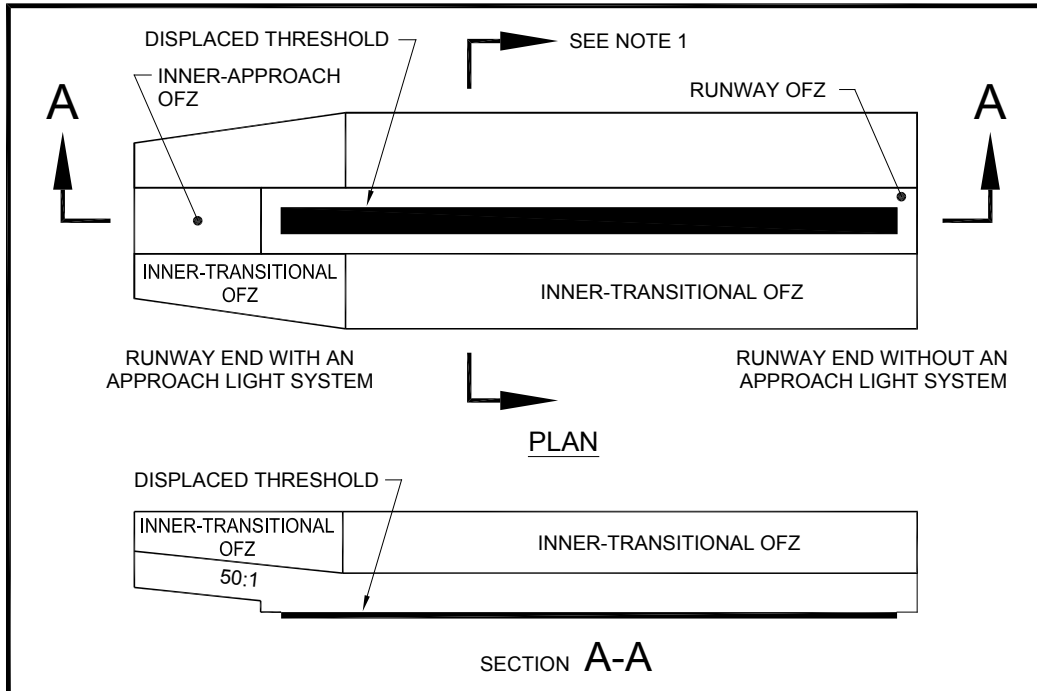
Note: 1. See Figure 3-13 for this view.

**Figure 3-10. OFZ for operations on runways by small aircraft with lower than 3/4 statute mile (1.2 km) approach visibility minimums**



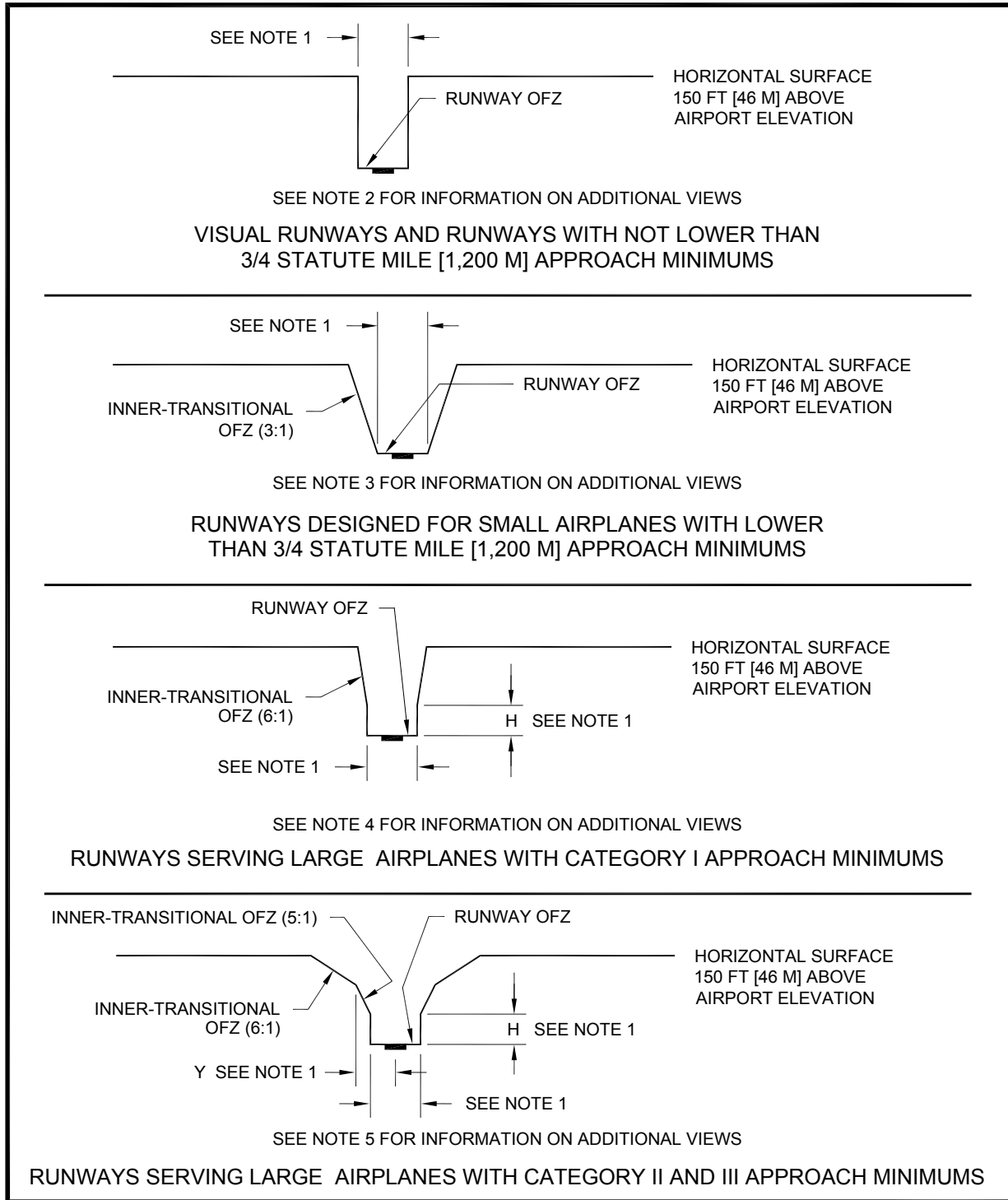
Note: 1. See Figure 3-13 for this view.

**Figure 3-11. OFZ for operations on runways by large aircraft with lower than 3/4 statute mile (1.2 km) approach visibility minimums**



Note: 1. See Figure 3-13 for this view.

**Figure 3-12. OFZ for operations on runways by large aircraft with lower than 3/4 statute mile (1.2 km) approach visibility minimums and displaced threshold**



**Notes:**

1. See paragraph 308 for additional information.
2. See Figure 3-9 for additional views.
3. See Figure 3-10 for additional views.
4. See Figure 3-11 for additional views.
5. See Figure 3-12 for additional views.

**Figure 3-13. Sectional views of the OFZ**



(2) For operations on runways by large aircraft, separate inner-transitional OFZ criteria apply for Category (CAT) I and CAT-II/III runways.

(a) For CAT-I runways, the inner-transitional OFZ begins at the edges of the ROFZ and inner-approach OFZ, then rises vertically for a height “H,” and then slopes 6 (horizontal) to 1 (vertical) out to a height of 150 feet (46 m) above the established airport elevation.

(i) In U.S. customary units,

$$H_{\text{feet}} = 61 - 0.094(S_{\text{feet}}) - 0.003(E_{\text{feet}}).$$

(ii) In SI units,

$$H_{\text{meters}} = 18.4 - 0.094(S_{\text{meters}}) - 0.003(E_{\text{meters}}).$$

(iii) S is equal to the most demanding wingspan of the RDC of the runway, and E is equal to the runway threshold elevation above sea level.

(b) For CAT-II/III runways, the inner-transitional OFZ begins at the edges of the ROFZ and inner-approach OFZ, then rises vertically for a height “H,” then slopes 5 (horizontal) to 1 (vertical) out to a distance “Y” from runway centerline, and then slopes 6 (horizontal) to 1 (vertical) out to a height of 150 feet (46 m) above the established airport elevation.

(i) In U.S. customary units,

$$H_{\text{feet}} = 53 - 0.13(S_{\text{feet}}) - 0.0022(E_{\text{feet}}) \text{ and}$$

$$Y_{\text{feet}} = 440 + 1.08(S_{\text{feet}}) - 0.024(E_{\text{feet}}).$$

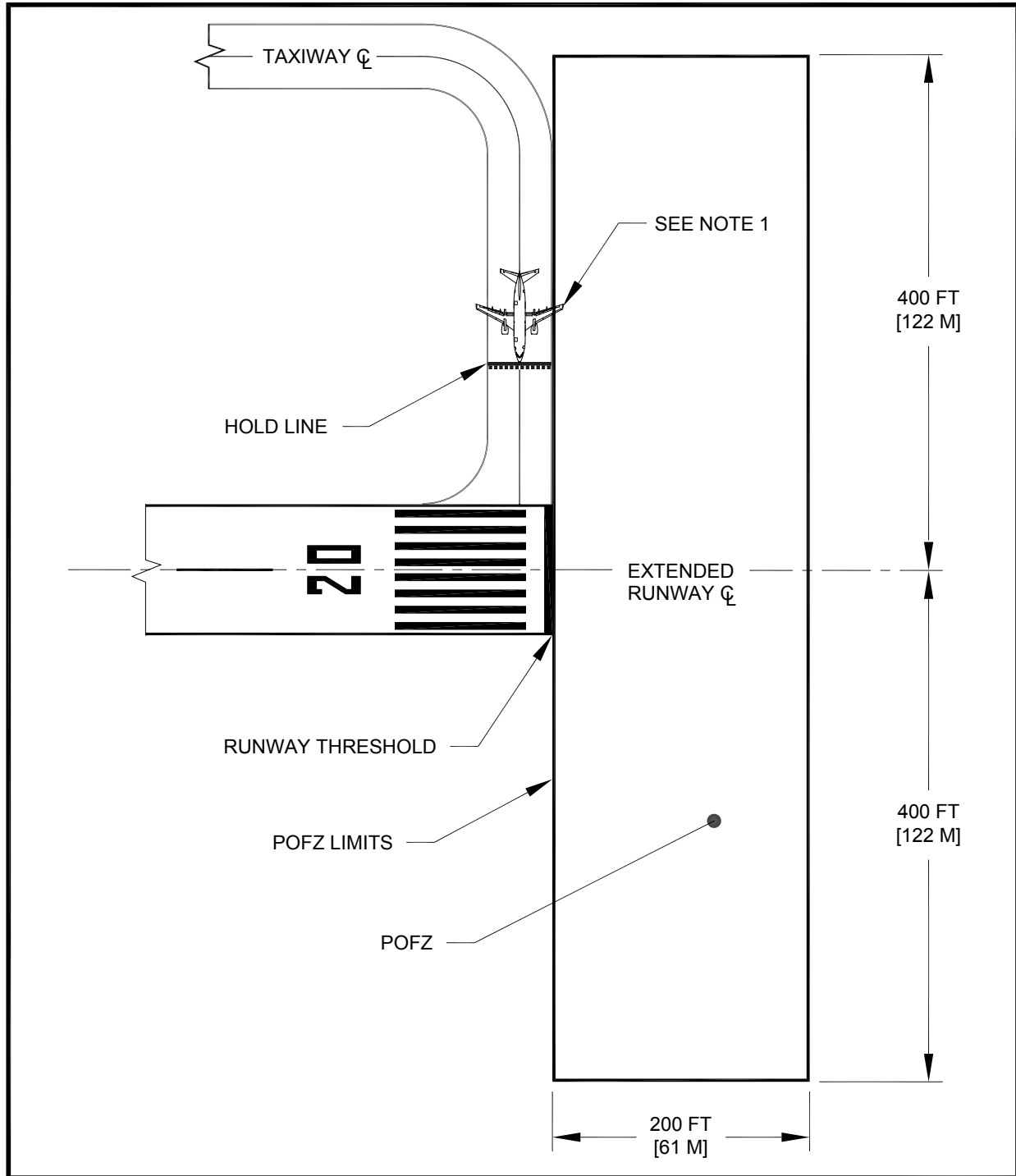
(ii) In SI units,

$$H_{\text{meters}} = 16 - 0.13(S_{\text{meters}}) - 0.0022(E_{\text{meters}}) \text{ and}$$

$$Y_{\text{meters}} = 132 + 1.08(S_{\text{meters}}) - 0.024(E_{\text{meters}}).$$

(iii) S is equal to the most demanding wingspan of the RDC of the runway and E is equal to the runway threshold elevation above sea level. Beyond the distance “Y” from runway centerline, the inner-transitional CAT-II/III OFZ surface is identical to that for the CAT-I OFZ.

**d. Precision Obstacle Free Zone (POFZ).** The POFZ is defined as a volume of airspace above an area beginning at the threshold at the threshold elevation and centered on the extended runway centerline (200 feet [61 m] long by 800 feet [244 m] wide). See [Figure 3-14](#).



**Note:**

1. When the POFZ is in effect, a wing of an aircraft on a taxiway waiting for runway clearance may penetrate the POFZ; however, neither the fuselage nor the tail may infringe on the POFZ.

**Figure 3-14. Precision Obstacle Free Zone (POFZ) – no displaced threshold**

(1) The surface is in effect only when all of the following operational conditions are met:

(a) The approach includes vertical guidance.

(b) The reported ceiling is below 250 feet (76 m) or visibility is less than 3/4 statute mile (1.2 km) (or Runway Visual Range [RVR] is below 4,000 feet [1219 m]).

(c) An aircraft is on final approach within 2 miles (3.2 km) of the runway threshold.

(2) When the POFZ is in effect, a wing of an aircraft holding on a taxiway waiting for runway clearance may penetrate the POFZ; however neither the fuselage nor the tail may penetrate the POFZ. Vehicles up to 10 feet (3 m) in height necessary for maintenance are also permitted in the POFZ.

(3) The POFZ is applicable at all runway thresholds including displaced thresholds. Refer to [Figure 3-15](#).

**309. Runway Object Free Area (ROFA).**

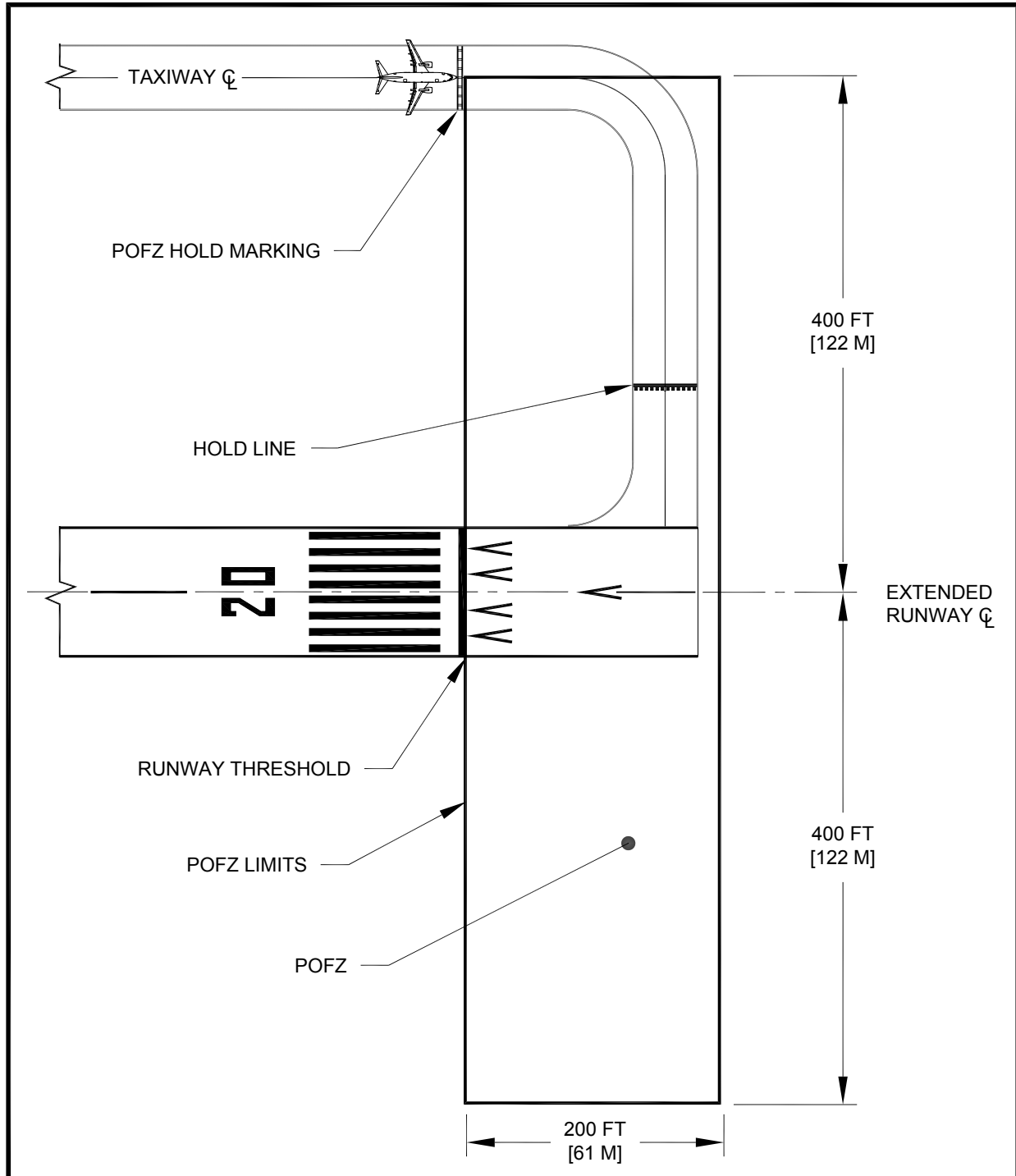
The ROFA is centered about the runway centerline. The ROFA clearing standard requires clearing the ROFA of above-ground objects protruding above the nearest point of the RSA. For new runways, terrain should not protrude above the nearest point of the RSA within a distance from the edge of the RSA equal to one-half the most demanding wingspan of the RDC of the runway. If not practicable to apply this standard to existing runways, a positive grade as shown in [Table 3-3](#) and [Figure 3-23](#) is permissible. Except where precluded by other clearing standards, it is acceptable for objects that need to be located in the ROFA for air navigation or aircraft ground maneuvering purposes to protrude above the nearest point of the RSA, and to taxi and hold aircraft in the ROFA. To the extent practicable, objects in the ROFA should meet the same fragility requirements as the RSA. Objects non-essential for air navigation or aircraft ground maneuvering purposes must not be placed in the ROFA. This includes parked aircraft and agricultural operations. Interactive [Table 3-5](#) specifies the standard dimensions of the ROFA. See [Figure 3-16](#).

**Table 3-3. Transverse grades**

Dimension	Approach Category	
	A & B	C, D, & E
S-1	1.0% - 2.0%	1.0% - 1.5%
S-2 (≥ S-1)	1.5% - 5.0%	1.5% - 5.0%
S-3	1.5% - 5.0%	1.5% - 3.0%

Dimension	ADG					
	I	II	III	IV	V	VI
D-1	D-1 is 1/2 of RSA width. See dimension C in interactive <a href="#">Table 3-5</a>					
D-2	25	40	59	86	107	131
S-4 (max)	8:1		10:1		16:1	

**Note:** See [Figure 3-23](#) and [Figure 4-33](#).

**Notes:**

1. It is normally undesirable to hold aircraft on the parallel portion of the taxiway. Consideration should be given to building the parallel taxiway at a greater distance from the runway centerline to avoid this situation. Refer to discussions on runway and taxiway separations in [Chapter 4](#). For additional information regarding POFZ hold markings, refer to [AC 150/5340-1](#).
2. Two hold lines are required, as the POFZ is only in effect during instrument meteorological conditions.

**Figure 3-15. POFZ – displaced threshold**

### **310. Runway Protection Zone (RPZ).**

The RPZ's function is to enhance the protection of people and property on the ground. This is best achieved through airport owner control over RPZs. Control is preferably exercised through the acquisition of sufficient property interest in the RPZ and includes clearing RPZ areas (and maintaining them clear) of incompatible objects and activities.

#### **a. RPZ background.**

(1) Approach protection zones were originally established to define land areas underneath aircraft approach paths in which control by the airport operator was highly desirable to prevent the creation of air navigation hazards. Subsequently, a 1952 report by the President's Airport Commission (chaired by James Doolittle), entitled *The Airport and Its Neighbors*, recommended the establishment of clear areas beyond runway ends. Provision of these clear areas was not only to preclude obstructions potentially hazardous to aircraft, but also to control building construction as a protection from nuisance and hazard to people on the ground. The Department of Commerce concurred with the recommendation on the basis that this area was "primarily for the purpose of safety and convenience to people on the ground." The FAA adopted "Clear Zones" with dimensional standards to implement the Doolittle Commission's recommendation. Guidelines were developed recommending that clear zones be kept free of structures and any development that would create a place of public assembly.

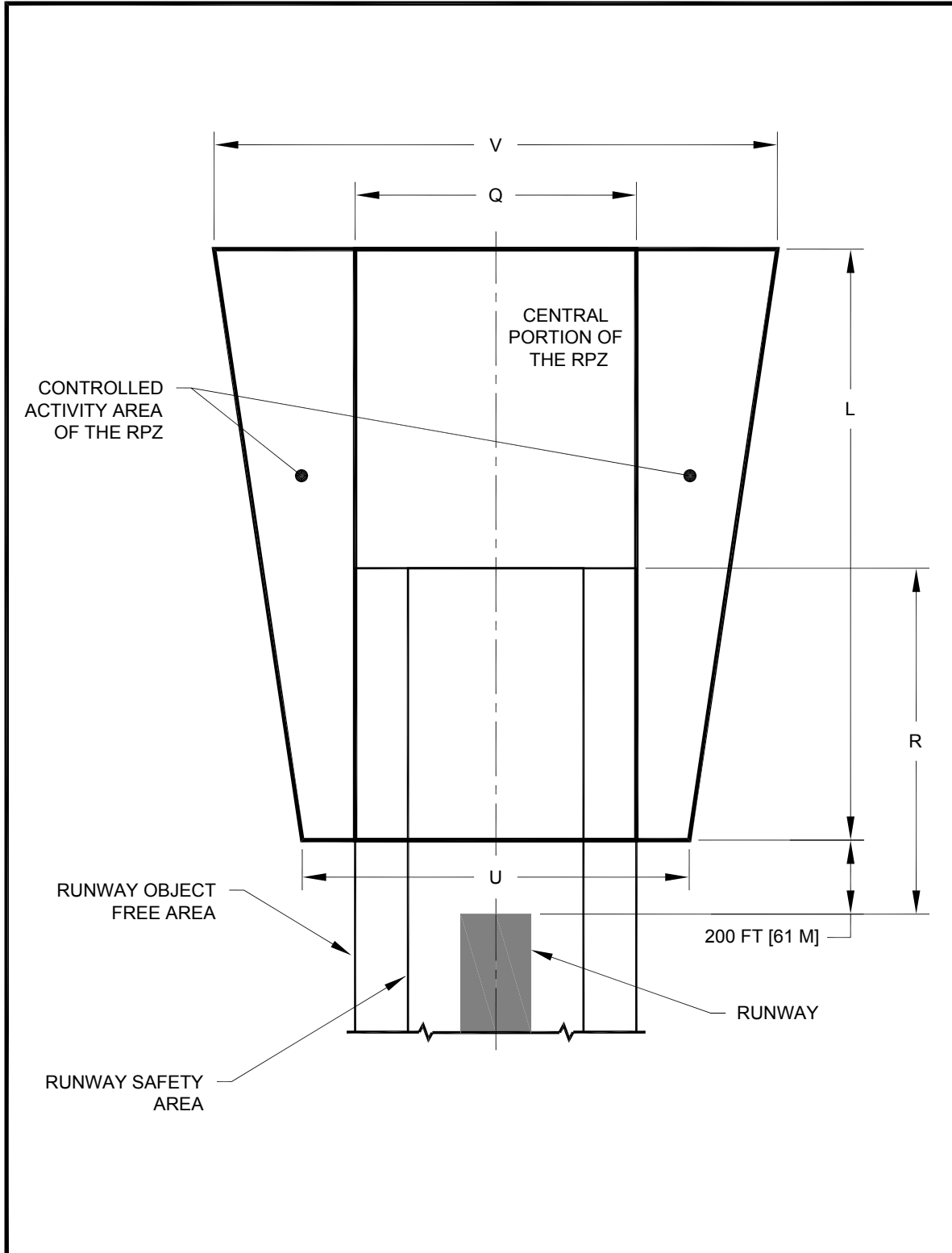
(2) In conjunction with the introduction of the RPZ as a replacement term for Clear Zone, the RPZ was divided into "extended object free" and "controlled activity" areas. The extended object free area has subsequently been renamed as the "central portion of the RPZ." The RPZ function is to enhance the protection of people and property on the ground. Where practical, airport owners should own the property under the runway approach and departure areas to at least the limits of the RPZ. It is desirable to clear the entire RPZ of all above-ground objects. Where this is impractical, airport owners, as a minimum, should maintain the RPZ clear of all facilities supporting incompatible activities. See FAA Memorandum, *Interim Guidance on Land Uses Within a Runway Protection Zone*, dated 9/27/2012, for guidance on incompatible activities.

#### **b. Standards.**

(1) **RPZ Configuration/Location.** The RPZ is trapezoidal in shape and centered about the extended runway centerline. The central portion and controlled activity area are the two components of the RPZ (see [Figure 3-16](#)).

(a) **Central Portion of the RPZ.** The central portion of the RPZ extends from the beginning to the end of the RPZ, centered on the runway centerline. Its width is equal to the width of the runway OFA (see [Figure 3-16](#)). Interactive [Table 3-5](#) contains the dimensional standards for the OFA and RPZ.

(b) **Controlled Activity Area.** The controlled activity area is the remaining area of the RPZ on either side of the central portion of the RPZ.



Note: See interactive [Table 3-5](#) for dimensions U, V, L, R, and Q.

**Figure 3-16. Runway Protection Zone (RPZ), Runway Object Free Area (ROFA) and Runway Safety Area (RSA)**

(2) **Approach/Departure RPZ.** The approach RPZ dimensions for a runway end is a function of the aircraft approach category and approach visibility minimum associated with the approach runway end. The departure RPZ is a function of the aircraft approach category and departure procedures associated with the runway. For a particular runway end, the more stringent RPZ requirements, usually the approach RPZ requirements, will govern the property interests and clearing requirements the airport owner should pursue.

**c. Location and size.** The RPZ may begin at a location other than 200 feet (61 m) beyond the end of the runway. When an RPZ begins at a location other than 200 feet (61 m) beyond the end of runway, two RPZs are required, i.e., a departure RPZ and an approach RPZ. The two RPZs normally overlap (refer to [Figure 3-17](#) and [Figure 3-18](#)).

(1) **Approach RPZ.** The approach RPZ extends from a point 200 feet (61 m) from the runway threshold, for a distance as shown in interactive [Table 3-5](#).

(2) **Departure RPZ.** The departure RPZ begins 200 feet (61 m) beyond the runway end or, if the Takeoff Run Available (TORA) and the runway end are not the same, 200 feet (61 m) beyond the far end of the TORA. The departure RPZ dimensional standards are equal to or less than the approach RPZ dimensional standards (refer to interactive [Table 3-5](#)).

(a) For runways designed for small aircraft in Aircraft Approach Categories A and B: Starting 200 feet (61 m) beyond the far end of TORA, 1,000 feet (305 m) long, 250 feet (76 m) wide, and RPZ 450 feet (137 m) wide at the far end.

(b) For runways designed for large aircraft in Aircraft Approach Categories A and B: starting 200 feet (61 m) beyond the far end of TORA, 1,000 feet (305 m) long, 500 feet (152 m) wide, and at the far end of RPZ 700 feet (213 m) wide.

(c) For runways designed for Aircraft Approach Categories C, D, and E: Starting 200 feet (61 m) beyond the far end of TORA, 1,700 feet (518 m) long, 500 feet (152 m) wide, and at the far end of RPZ 1,010 feet (308 m) wide.

**d.** For RPZ land, the following land uses are permissible without further evaluation:

(1) Farming that meets airport design standards.

(2) Irrigation channels that meet the requirements of [AC 150/5200-33](#) and FAA/USDA manual, [Wildlife Hazard Management at Airports](#).

(3) Airport service roads, as long as they are not public roads and are directly controlled by the airport operator.

(4) Underground facilities, as long as they meet other design criteria, such as RSA requirements, as applicable.

(5) Unstaffed NAVAIDs and facilities, such as equipment for airport facilities that are considered fixed-by-function in regard to the RPZ.

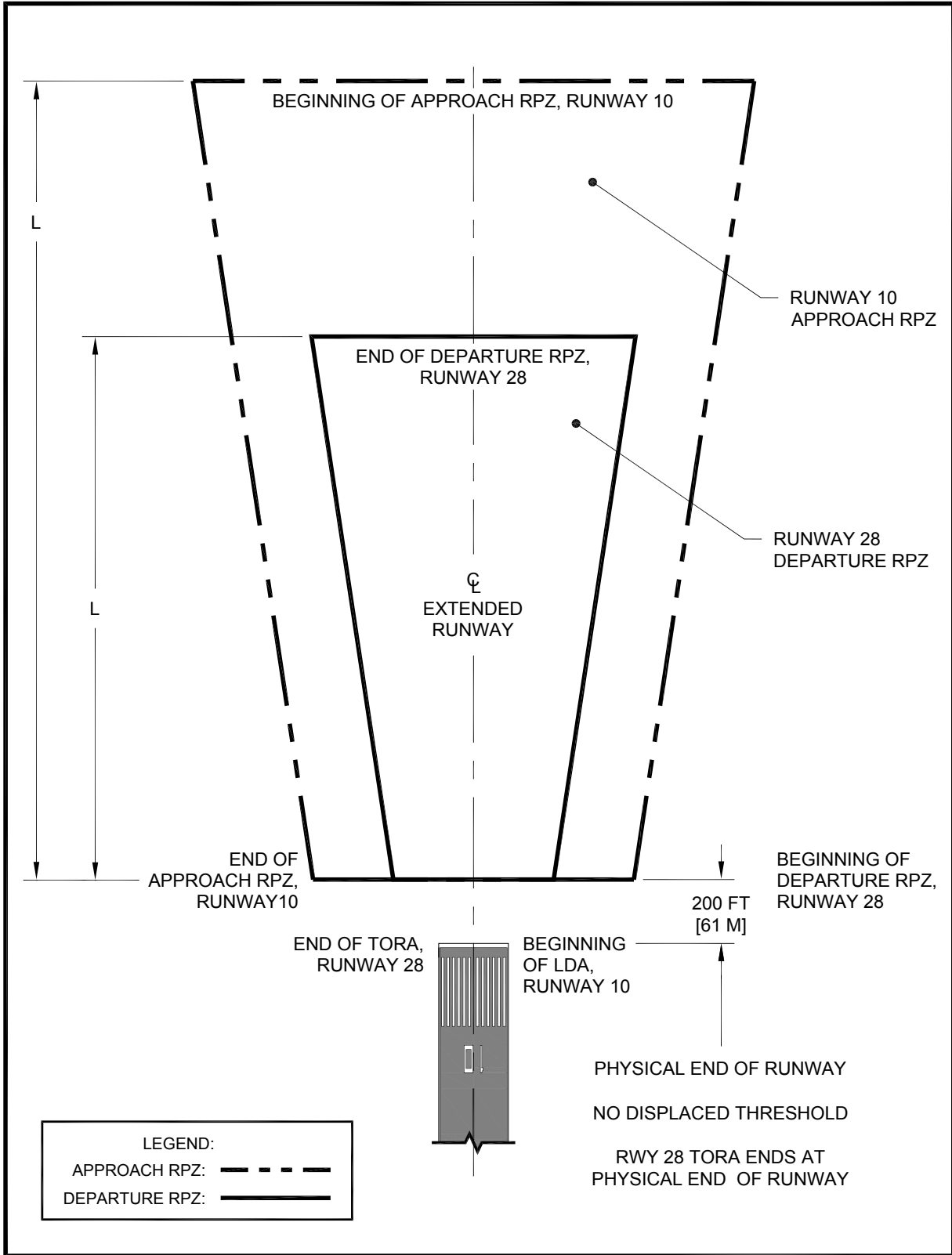
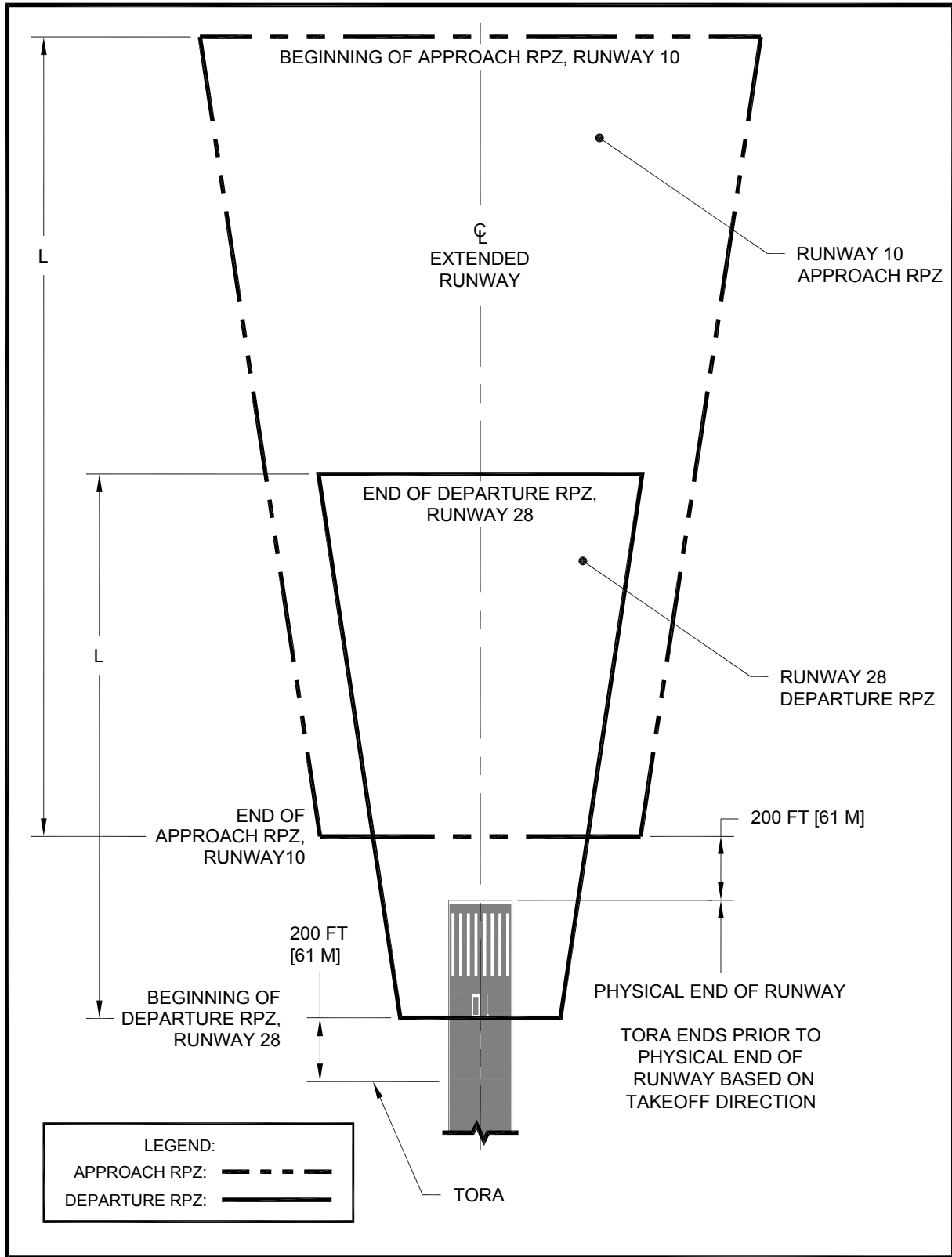


Figure 3-17. Runway with all declared distances equal to the runway length





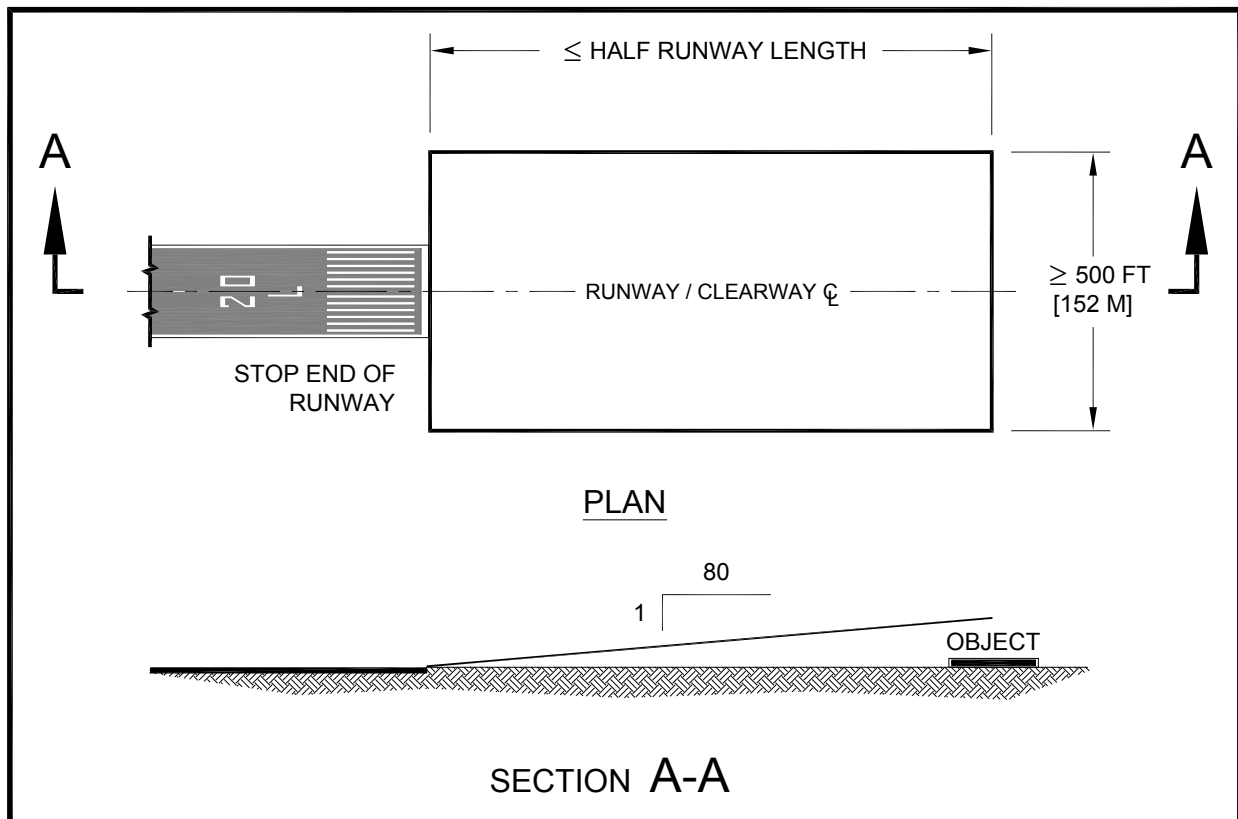
**Figure 3-18. Approach and departure RPZs where the Takeoff Run Available (TORA) is less than the Takeoff Distance Available (TODA)**

### 311. Clearway standards.

The clearway (see [Figure 3-19](#)) is an area extending beyond the runway end available for completion of the takeoff operation of turbine-powered aircraft. A clearway increases the allowable aircraft operating takeoff weight without increasing runway length. The use of a clearway for takeoff computations requires compliance with the clearway definition of [Part 1](#).

**a. Dimensions.** The clearway must be at least 500 feet (152 m) wide centered on the runway centerline. The length may be no more than  $\frac{1}{2}$  the runway length.

**b. Clearway plane slope.** The clearway plane slopes upward with a slope not greater than 1.25 percent (80:1).



**Figure 3-19. Clearway**

**c. Clearing.** No object or terrain may protrude through the clearway plane except for threshold lights no higher than 26 inches (66 cm) and located off the runway sides. The area over which the clearway lies need not be suitable for stopping aircraft in the event of an aborted takeoff.

**d. Control.** A clearway must be under the airport owner's control, although not necessarily by direct ownership. The purpose of such control is to ensure that no fixed or movable object penetrates the clearway plane during a takeoff operation.

**e. Notification.** When a clearway is provided, the clearway length and the declared distances, as specified in paragraph 322.a, must be provided in the Airport/Facility Directory A/FD (and in the Aeronautical Information Publication for international airports) for each operational direction. When a clearway is provided at an airport with an FAA-approved Airport Layout Plan (ALP), it must be designated on the ALP.

**f. Clearway location.** The clearway is located at the far end of TORA. The portion of runway extending into the clearway is unavailable and/or unsuitable for takeoff run and takeoff distance computations.

### **312. Stopway standards.**

A stopway is an area beyond the takeoff runway centered on the extended runway centerline and designated by the airport owner for use in decelerating an aircraft during an aborted takeoff. (See Figure 3-20.) It must be at least as wide as the runway and able to support an aircraft during an aborted takeoff without causing structural damage to the aircraft. Refer to AC 150/5320-6 for pavement strength requirements for a stopway. Their limited use and high construction cost, when compared to a full-strength runway that is usable in both directions, makes their construction less cost effective. When a stopway is provided, the stopway length and the declared distances must be provided in the A/FD (and in the Aeronautical Information Publication for international airports), as specified in paragraph 322.f, for each operational direction. The use of a stopway for takeoff computations requires that the stopway complies with the definition of Part 1. This definition can be found in paragraph 102.zzz. When a stopway is provided at an airport with an FAA-approved ALP, it must be designated on the approved ALP.

### **313. Surface gradient.**

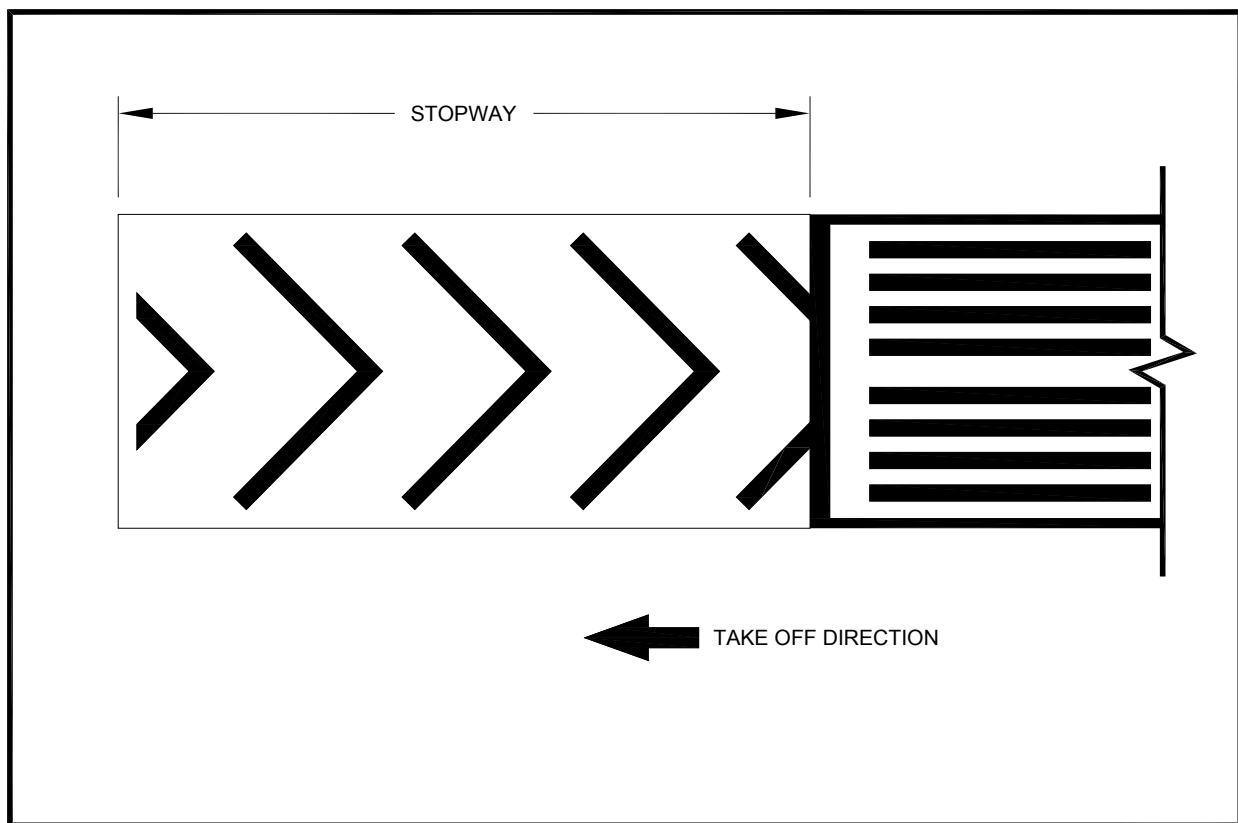
**a. Aircraft approach categories A and B.** The longitudinal gradient standards for the centerline of runways and stopways are as follows and as illustrated in Figure 3-21. Keep longitudinal grades and grade changes to a minimum.

- (1) The maximum longitudinal grade is  $\pm 2.0$  percent.
- (2) The maximum allowable grade change is  $\pm 2.0$  percent.
- (3) Vertical curves for longitudinal grade changes are parabolic. The length of the vertical curve is a minimum of 300 feet (91 m) for each 1.0 percent of change. A vertical curve is not necessary when the grade change is less than 0.40 percent.
- (4) The minimum allowable distance between the points of intersection of vertical curves is 250 feet (76 m) multiplied by the sum of the grade changes (in percent) associated with the two vertical curves.
- (5) Present maximum and minimum transverse grades for runways and stopways. Keep transverse grades to a minimum and consistent with local drainage requirements. The ideal configuration is a center crown with equal, constant transverse grades on either side. However, an off-center crown with different grades on either side and with

changes in transverse grade (other than from one side of the crown to the other) of no more than 0.5 percent more than 25 feet (7.6 m) from the runway crown is permissible.

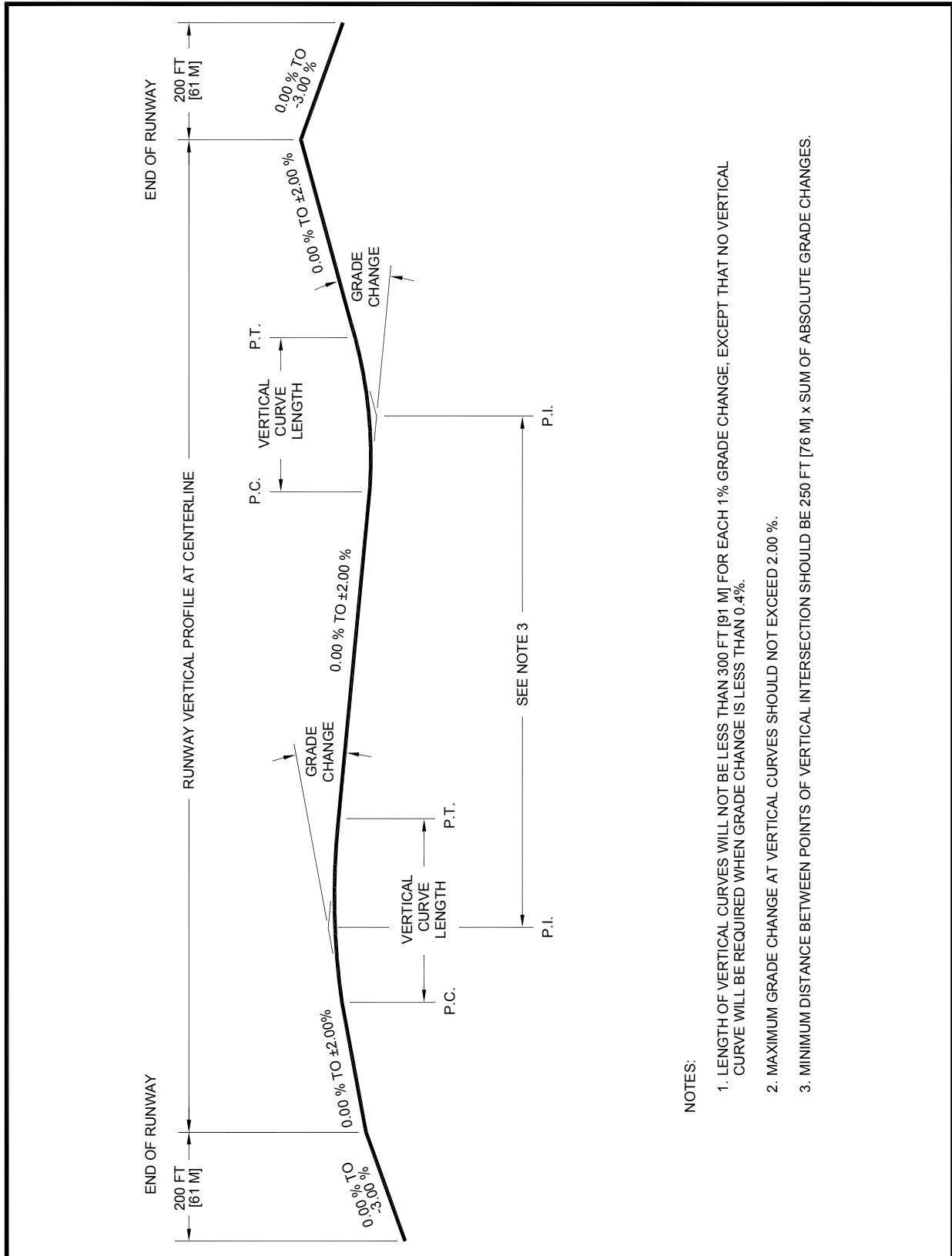
(6) Provide a smooth transition between the intersecting pavement surfaces as well as adequate drainage of the intersection. Give precedence to the grades for the dominant runway (e.g., higher speed, higher traffic volume, etc.) in a runway-runway situation. Give precedence to the runway in a runway-taxiway situation.

(7) Consider potential runway extensions and/or the future upgrade of the runway to a more stringent aircraft approach category when selecting the longitudinal and transverse grade of the runway. If such extensions and/or upgrades are shown on the ALP, design grades according to the ultimate plan.



**Note:** See [AC 150/5340-1](#) for stopway markings.

**Figure 3-20. Stopway**



NOTES:

1. LENGTH OF VERTICAL CURVES WILL NOT BE LESS THAN 300 FT [91 M] FOR EACH 1% GRADE CHANGE, EXCEPT THAT NO VERTICAL CURVE WILL BE REQUIRED WHEN GRADE CHANGE IS LESS THAN 0.4%.
2. MAXIMUM GRADE CHANGE AT VERTICAL CURVES SHOULD NOT EXCEED 2.00 %.
3. MINIMUM DISTANCE BETWEEN POINTS OF VERTICAL INTERSECTION SHOULD BE 250 FT [76 M] x SUM OF ABSOLUTE GRADE CHANGES.

Figure 3-21. Longitudinal grade limitations for aircraft approach categories A and B

**b. Aircraft approach categories C, D and E.** The longitudinal gradient standards for the centerline of runways and stopways are as follows and as illustrated in Figure 3-22. Keep longitudinal grades and grade changes to a minimum.

(1) The maximum longitudinal grade is  $\pm 1.50$  percent; however, longitudinal grades may not exceed  $\pm 0.80$  percent in the first and last quarter, or first and last 2,500 feet (762 m), whichever is less, of the runway length.

(2) The maximum allowable grade change is  $\pm 1.50$  percent; however, no grade changes are allowed in the first and last quarter, or first and last 2,500 feet (762 m), whichever is less, of the runway length.

(3) Vertical curves for longitudinal grade changes are parabolic. The length of the vertical curve is a minimum of 1,000 feet (305 m) for each 1.0 percent of change.

(4) The minimum allowable distance between the points of intersection of vertical curves is 1,000 feet (305 m) multiplied by the sum of the grade changes (in percent) associated with the two vertical curves.

(5) Present maximum and minimum transverse grades for runways and stopways. Keep transverse grades to a minimum and consistent with local drainage requirements. The ideal configuration is a center crown with equal, constant transverse grades on either side. However, an off-center crown, different grades on either side, and changes in transverse grade (other than from one side of the crown to the other) of no more than 0.5 percent more than 25 feet (7.6 m) from the runway crown are permissible.

(6) Provide a smooth transition between intersecting pavement surfaces as well as adequate drainage of the intersection. Give precedence to the grades for the dominant runway (e.g., higher speed, higher traffic volume, etc.) in a runway-runway situation. Give precedence to the runway in a runway-taxiway situation.

(7) Consider potential runway extensions when selecting the longitudinal and transverse grade of the runway. If such extensions are shown on the ALP, design grades according to the ultimate plan.

**c. Intersecting runways.** Any grade issues concerning intersecting runways on an airport are resolved in the following manner:

(1) The surface gradient requirements for the primary or higher category runway take precedence over the lower category runway.

(2) If the lower category runway cannot meet longitudinal gradient standards because of the gradient requirements of the higher category runway, the airport owner should contact the appropriate FAA Airports office to consider all options for the intersecting runways to meet the aeronautical needs of the airport.

(3) Transverse grades may have to be adjusted to avoid excessive runway roughness. Also, flatter grades that provide adequate drainage are acceptable at intersections.

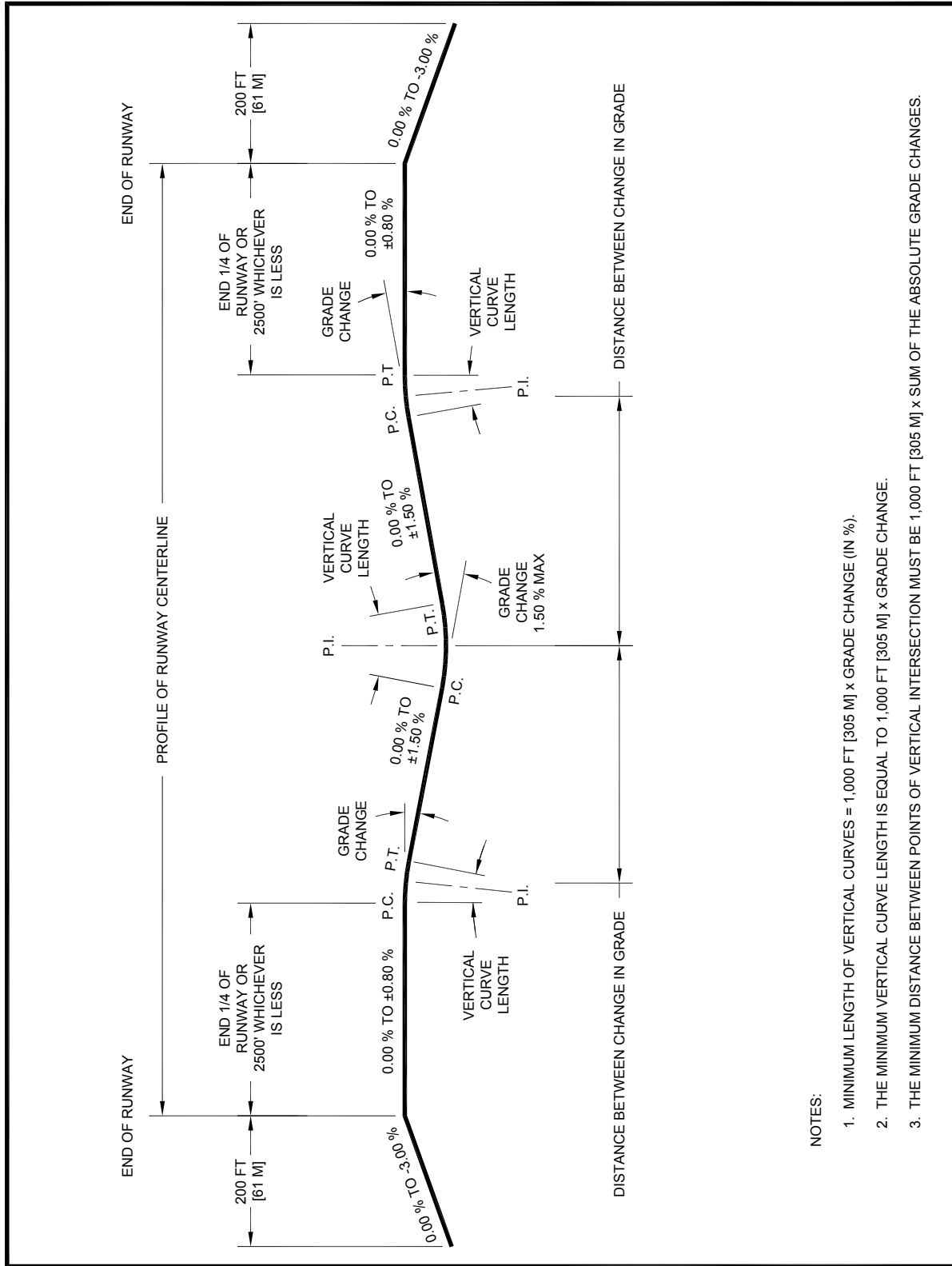


Figure 3-22. Longitudinal grade limitations for aircraft approach categories C, D, and E

**d. RSA grades.** The longitudinal and transverse gradient standards for RSAs are as follows and as illustrated in [Figure 3-21](#), [Figure 3-22](#), [Figure 3-23](#) and [Figure 3-24](#).

(1) Longitudinal grades, longitudinal grade changes, vertical curves, and distance between changes in grades for that part of the RSA between the runway ends are the same as the comparable standards for the runway and stopway. Exceptions are allowed when necessary because of taxiways or other runways within the area. In such cases, modify the longitudinal grades of the RSA by the use of smooth curves. For the first 200 feet (61 m) of the RSA beyond the runway ends, the longitudinal grade is between 0 and 3.0 percent, with any slope being downward from the ends. For the remainder of the safety area ([Figure 3-24](#)), the maximum allowable positive longitudinal grade is such that no part of the RSA penetrates any applicable approach surface or clearway plane. The maximum allowable negative grade is 5.0 percent. Limitations on longitudinal grade changes are plus or minus 2.0 percent per 100 feet (30 m). Use parabolic vertical curves where practical. Avoid the use of maximum grades if possible. The ability for an overrunning aircraft to stop within the RSA is decreased as the downhill grade increases. Also, using maximum grades may result in approach lights and/or a LOC being mounted on non-frangible supports and degraded LOC performance.

(2) [Table 3-3](#) and [Figure 3-23](#) show the maximum and minimum transverse grades for paved shoulders and for the RSA along the runway up to 200 feet (61 m) beyond the runway end. In all cases, keep transverse grades to a minimum, consistent with local drainage requirements.

(3) [Figure 3-24](#) illustrates the criteria for the transverse grade beginning 200 feet (61 m) beyond the runway end.

(4) The top elevation of the concrete bases for NAVAIDs located in the RSA must not be higher than 3 inches (76 mm) above the finished grade. Other grading requirements for NAVAIDs located in the RSA are, in most cases, more stringent than those stated above. See [Chapter 6](#).

### **314. Turf runways.**

Turf runways are a low cost alternative to paved runways. Turf runways can be used in many locations where traffic volume is low and aircraft wheel loading is light, such as small aircraft with low approach and takeoff speeds. Turf runways are preferred by some pilots, especially those flying aircraft with tailwheel or tailskid type landing gear, gliders, agriculture sprayers, and aircraft with tundra tires. Turf runways are normally not compatible with instrument procedures without Flight Standards approval.

**a. Runway length.** Due to the nature of turf runways, landing, takeoff, and accelerate-stop distances are longer than for paved runways. For landing and accelerate-stop, the distance is longer due to less friction available for braking action. For takeoff, the uneven ground surface and higher rolling resistance increases takeoff distances as compared to paved surfaces. It is recommended that distances for aircraft (landing, takeoff, and accelerate-stop) be increased by a factor of 1.2.



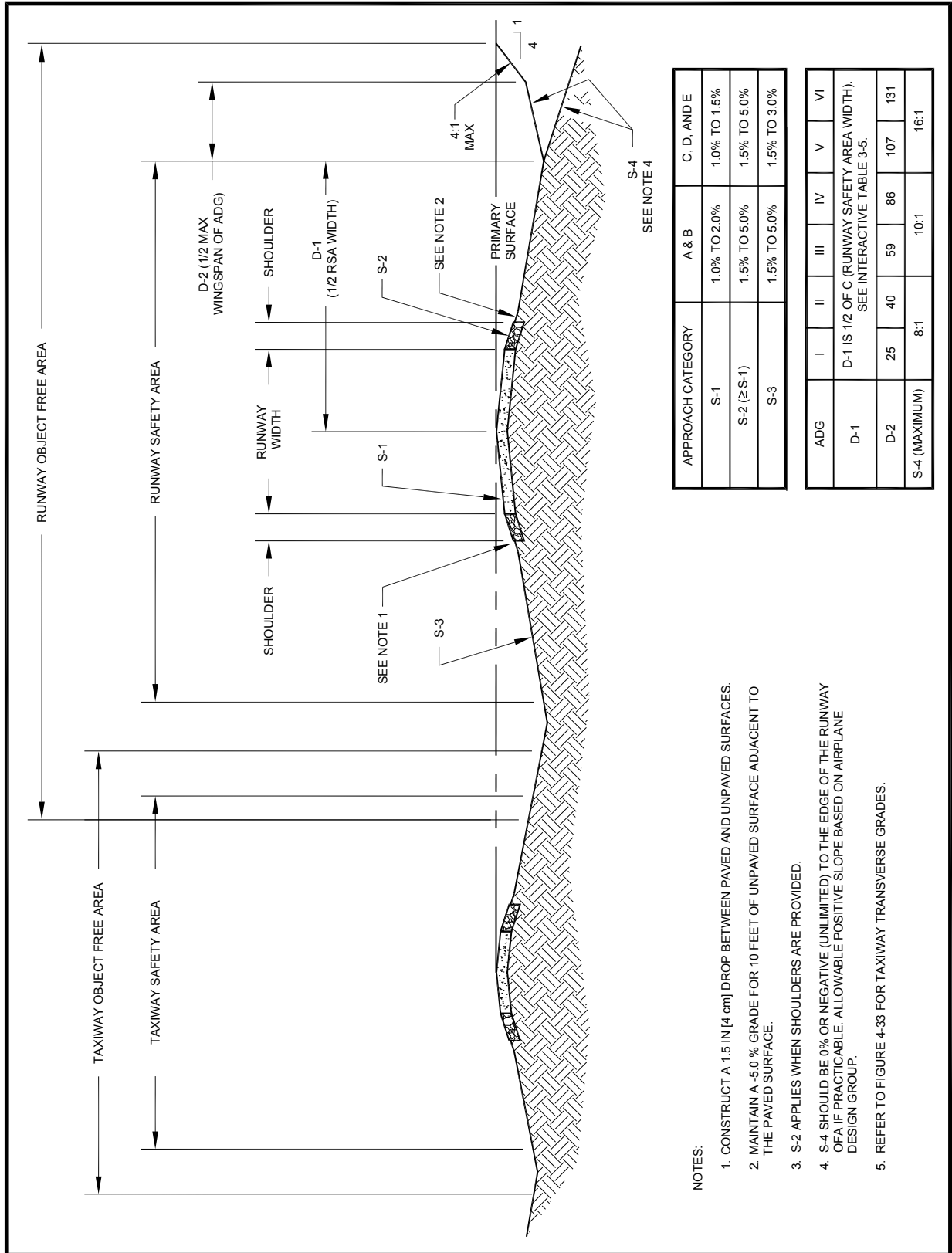
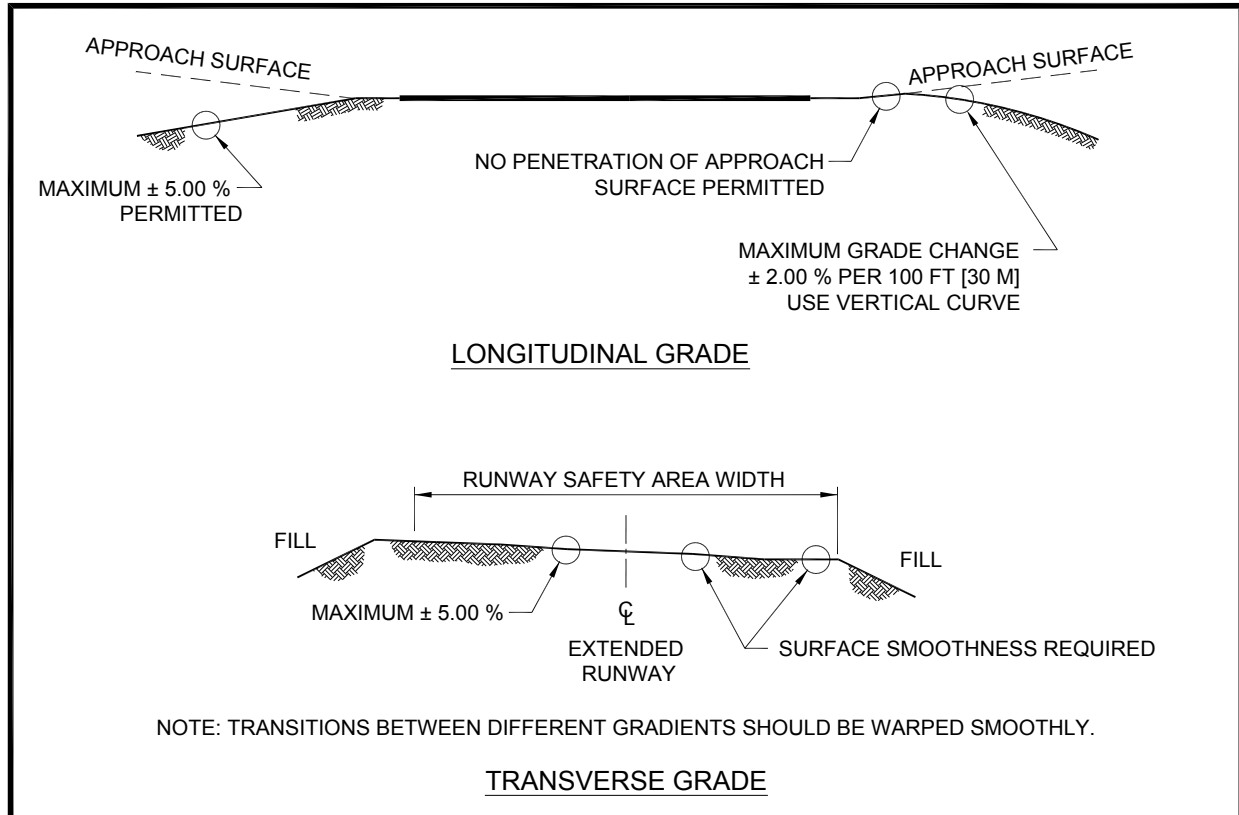


Figure 3-23. Transverse grade limitations



**Figure 3-24. RSA grade limitations beyond 200 feet (61 m) from the runway end**

**b. Runway width.** Runway width standards are the same as for paved runways. Runway safety area standards also apply.

**c. Grading.** Turf runways must be kept well drained or they will not be able to support an aircraft in wet conditions. It is recommended that turf runways be graded to provide at least a 2.0 percent slope away from the center of the runway for a minimum distance of 40 feet (12 m) on either side of the centerline of the landing strip and a 5.0 percent slope from that point to the edge of the RSA to provide rapid drainage. In order to provide adequate drainage yet still provide a low construction cost, it is recommended that drainage swales be constructed with a maximum of a 3.0 percent slope parallel to the runway and outside of the RSA. Such swales can then be mowed with standard mowing equipment while eliminating drainage pipe and structures.

**d. Compaction.** Turf runways should be compacted to the same standards as required for the RSA for paved runways (see paragraph 307.c).

**e. Vertical curves.** Grade changes should not exceed 3.0 percent and the length of the vertical curve must equal at least 300 feet (91 m) for each 1.0 percent change.

**f. Thresholds.** Thresholds should be permanently identified to ensure that airspace evaluation is valid for the runway. Turf runways that are mowed to fence lines with no distinct threshold location marked can be hazardous due to the adjacent fences, roads, trees, and power lines. One type of permanent marker is a threshold strip of concrete pavement, 60 feet (18.5 m)

wide by 10 feet (3 m) long, painted white. No portion of the concrete pavement should be more than 1.5 inches (38 mm) above the surrounding grade level. Frangible cones may also be used for this purpose. Ensure that approaches have clear 20:1 approach slopes starting at the threshold.

**g. Landing strip boundary markers.** Low mass cones, frangible reflectors, and Low Intensity Runway Lights (LIRL) may all be used to mark the landing strip boundary. Tires, barrels, and other high mass non-frangible items should not be used for this purpose. The maximum distance between such objects should not be more than 400 feet (122 m). The preferred interval is 200 feet (61 m). Boundary markers must be located outside of the RSA.

**h. Hold markings.** Hold position markings should be provided to ensure adequate runway clearance for holding aircraft.

**i. Types of turf.** Soil and climate determine the selection of grasses that may be grown. Grasses used for airport turf should have a deep, matted root system that produces a dense, smooth surface cover with a minimum of top growth. Grasses that are long-lived, durable, strong creepers and recover quickly from dormancy or abuse should be selected in preference to the quick growing but short lived, shallow-rooted, weak sod species. Wherever practical, seeding should be timed so that a period of at least six weeks of favorable growing conditions follows the time of germination before frost or drought occurs. AC 150/5370-10, Part 10 – Turfing, provides additional information on turf establishment.

### **315. Marking and lighting.**

**a. Runway holding position (holdline).** At airports with operating ATCTs, runway holding positions (holdlines) identify the location on a taxiway where a pilot is to stop when he/she does not have clearance to proceed onto the runway. At airports without operating control towers, these holdlines identify the location where a pilot should ensure there is adequate separation from other aircraft before proceeding onto the runway. The holdline standards, which assume a perpendicular distance from a runway centerline to an intersecting taxiway centerline, are in interactive Table 3-5. However, these distance standards may need to be increased and the marking be placed to take into account the largest aircraft (tail, body or wing tip) when the taxiway intersects the runway at an acute angle.

**b. Marking at intersecting runways.** Refer to AC 150/5340-1 for the current airport marking standards. Any marking issues concerning intersecting runways on an airport are to be resolved in the following manner:

(1) The marking requirements for the dominant or higher category runway will take precedence over the lower, or lesser, category runway(s).

(2) If the lesser (lower) category runway(s) cannot meet the marking standards because of requirements of the higher category runway, the airport owner must request an aeronautical study that will consider all marking options for the intersecting runways. Recommendations and marking modifications will be implemented according to the findings of the aeronautical study.

**c. Runway lighting.** Refer to the appropriate lighting ACs in the AC 150/5340 and AC 150/5345 series to properly design airfield and runway lighting. A listing of these ACs can be found in paragraph 108.

### **316. Parallel runway separation requirements.**

**a. Parallel runway separation--simultaneous Visual Flight Rules (VFR) operations.**

**(1) Standard.** For simultaneous landings and takeoffs using VFR, the minimum separation between centerlines of parallel runways is 700 feet (213 m).

**(2) Recommendations.** The minimum runway centerline separation distance recommended for ADG-V and VI runways is 1,200 feet (366 m). Air Traffic Control (ATC) practices, such as holding aircraft between the runways, frequently justify greater separation distances. Runways with centerline spacings under 2,500 feet (762 m) are normally treated as a single runway by ATC when wake turbulence is a factor.

**b. Parallel runway separation--simultaneous Instrument Flight Rules (IFR) operations.** To attain IFR capability for simultaneous (independent) landings and takeoff on parallel runways, the longitudinal (in-trail) separation required for single runway operations is replaced, in whole or in part, by providing lateral separation between aircraft operating to parallel runways. Subparagraphs (1) and (2) identify the minimum centerline separations for parallel runways. Where practical, parallel runway centerline separation of at least 5,000 feet (1524 m) is recommended. Placing the terminal area between the parallel runways minimizes taxi operations across active runways and increases operational efficiency of the airport. Terminal area space needs may dictate greater separations than required for simultaneous IFR operations.

**(1) Simultaneous Approaches.** Precision instrument operations require electronic NAVAIDs and monitoring equipment, ATC, and approach procedures.

**(a) Dual simultaneous precision instrument approaches** are normally approved on parallel runway centerline separation of 4,300 feet (1311 m). On a case-by-case basis, the FAA will consider proposals utilizing separations down to a minimum of 3,000 feet (914 m) where a 4,300 foot (1311 m) separation is impractical. This reduction of separation requires special high update radar, monitoring equipment, etc.

**(b) Triple simultaneous precision instrument approaches** for airports below 1,000 feet (305 m) elevation normally require parallel runway centerline separation of 5,000 feet (1524 m) between adjacent runways. Triple simultaneous precision instrument approaches for airport elevations at and above 1,000 feet (305 m) and reduction in separation are currently under study by the FAA. In the interim, the FAA will, on a case-by-case basis, consider proposals utilizing separations down to a minimum of 4,300 feet (1311 m) where a 5,000-foot (1524 m) separation is impractical or the airport elevation is at or above 1,000 feet (305 m). Reduction of separation may require special radar, monitoring equipment, etc.

**(c) Quadruple simultaneous precision instrument approaches** are currently under study by the FAA. In the interim, the FAA, on a case-by-case basis, will

consider proposals utilizing separations down to a minimum of 5,000 feet (1524 m). Quadruples may require special radar, monitoring equipment, etc.

(2) Simultaneous Departures or Approaches and Departures. Simultaneous departures do not always require radar Air Traffic Control Facilities (ATC-F). The following parallel runway centerline separations apply:

(a) Simultaneous Departures.

i. Simultaneous non-radar departures require a parallel runway centerline separation of at least 3,500 feet (1067 m).

ii. Simultaneous radar departures require a parallel runway centerline separation of at least 2,500 feet (762 m).

(b) Simultaneous Approach and Departure. Simultaneous radar-controlled approaches and departures require the following parallel runway centerline separations:

i. When the thresholds are not staggered, at least 2,500 feet (762 m).

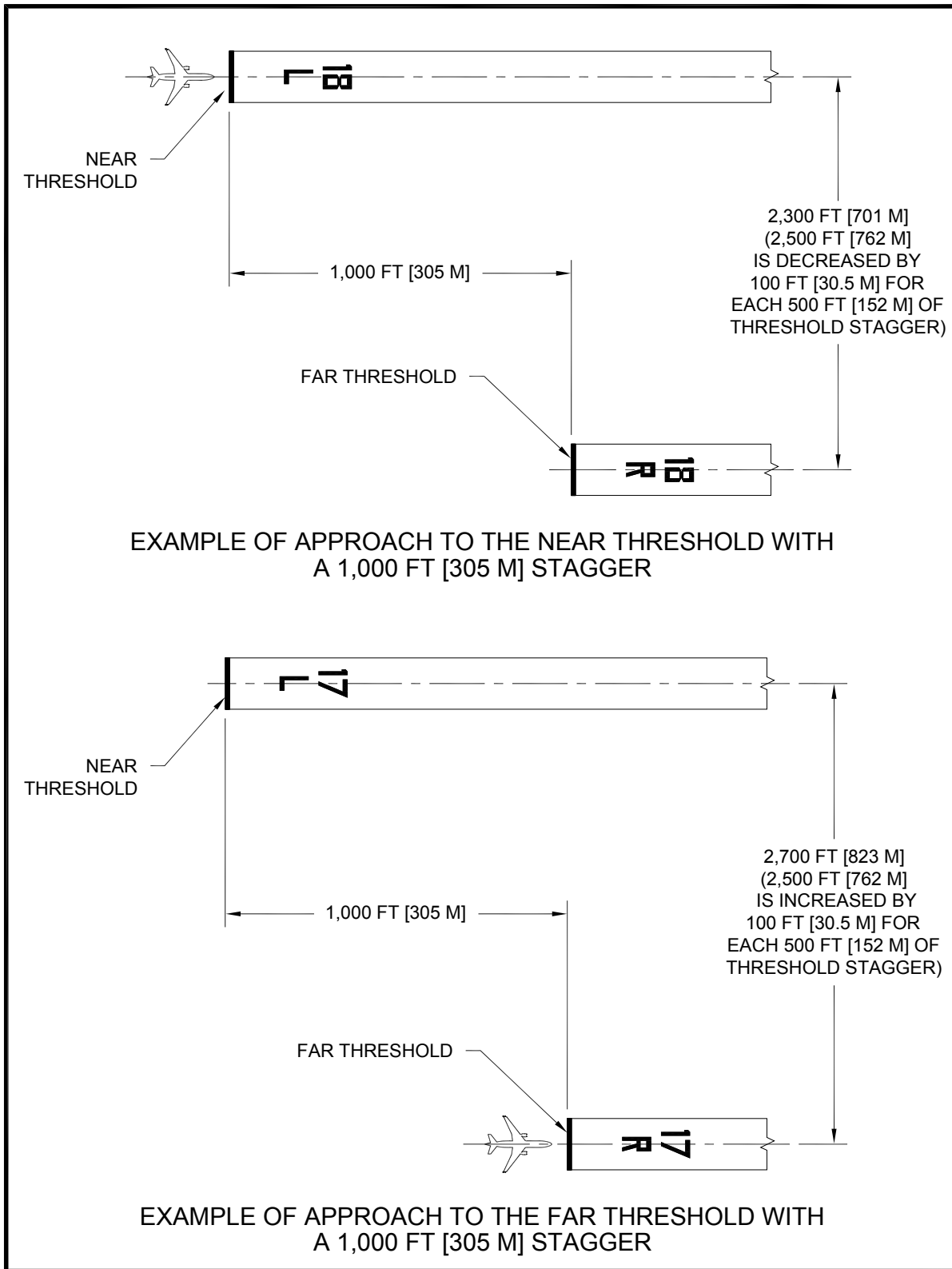
ii. When the thresholds are staggered and the approach is to the near threshold, the 2,500-foot (762 m) separation can be reduced by 100 feet (30 m) for each 500 feet (152 m) of threshold stagger to a minimum separation of 1,000 feet (305 m). For ADGs V and VI runways, a separation of at least 1,200 feet (366 m) is recommended. See [Figure 3-25](#) for a description of “near” and “far” thresholds.

iii. When the thresholds are staggered and the approach is to the far threshold, the minimum 2,500-foot (762 m) separation requires an increase of 100 feet (30 m) for every 500 feet (152 m) of threshold stagger. See [Figure 3-25](#).

### 317. Approach procedures.

a. **Background.** This paragraph applies to the establishment of new and revised authorized IAPs.

(1) This paragraph identifies airport landing surface requirements to assist airport operators in their evaluation and preparation of the airport landing surface to support new and revised IAPs. It also lists the airport data provided by the procedure sponsor that the FAA needs to conduct the airport airspace analysis specified in [Order JO 7400.2](#). The airport must be acceptable for IFR operations based on an Airport Airspace Analysis (AAA), under [Order JO 7400.2](#).



**Figure 3-25. Parallel runway separation, simultaneous radar controlled approach – staggered threshold**

(2) This paragraph reflects the requirements specified by Order 8260.3 when planning for IAPs capable of achieving normal landing minimums. This order also references other FAA requirements, such as a safety analysis to determine the need for approach lighting and other visual enhancements to mitigate the effects of a difficult approach environment. This is a consideration regardless of whether a reduction in approach minimums is desired.

(3) The tables provided in this paragraph are for planning purposes only and should be used in conjunction with the rest of the document. All pertinent requirements within this AC and other FAA documents, as well as local siting conditions, ultimately will determine the lowest minimums obtainable.

(4) Airport operators are always encouraged to consider an ALS to enhance the safety of an instrument procedure. In the absence of any identified benefits or safety enhancement from an approach light system, airport operators should at least consider installing lower cost visual guidance aids such as Runway End Identifier Lights (REIL) or Precision Approach Path Indicator (PAPI).

**b. Introduction.** To be authorized for a new IAP, the runway must have an instrument runway designation. Instrument runways are runway end specific. The runway end designation is based on the findings of an AAA study (refer to Order JO 7400.2). In addition, for all obligated National Plan of Integrated Airport Systems (NPIAS) airports, the instrument runway designation for the desired minimums must be depicted on the FAA approved ALP. If not depicted, a change to the ALP is required. As part of the ALP approval process, the FAA will conduct an AAA study to determine the runway's acceptability for the desired minimums.

**c. Action.** The airport landing surface must meet the standards specified in Table 3-4 for each specified runway, direction and have adequate airspace to support the IAP. When requesting an instrument procedure, the airport operator must specify the runway direction, the desired approach minimums, whether circling approach procedures are desired, and the survey needed to support the procedure. For all obligated NPIAS airports, the sponsor must also provide a copy of the FAA-approved ALP showing the instrument procedure(s) requested. An ALP is also recommended for all other airports.

**d. Airport aeronautical surveys.**

(1) Use the standards identified in AC 150/5300-16, AC 150/5300-17, and AC 150/5300-18 to survey and compile the appropriate data to support the development of instrument procedures.

(2) When the runway has or is planned to have an approach that has vertical guidance, use the Vertically Guided Airport Airspace Analysis Survey criteria in AC 150/5300-18.

(3) When the runway has or is planned to have an approach without vertical guidance, use the Non-Vertically Guided Airport Airspace Analysis Survey criteria in AC 150/5300-18.

**Table 3-4. Standards for Instrument Approach Procedures**

Visibility Minimums <sup>1</sup>	< 3/4 statute mile	3/4 to < 1 statute mile	≥ 1 statute mile straight-in	Circling <sup>2</sup>
HATh <sup>3</sup>	< 250 ft	≥ 250 ft	≥ 250 ft	≥ 350 ft
TERPS GQS <sup>4</sup>	Clear	Clear	Clear	Not applicable
PA final approach surfaces <sup>5</sup>	Clear	Not Required	Not Required	Not applicable
POFZ (PA & APV only)	Required	Not Required	Not Required	Not applicable
TERPS Chapter 3, Section 3	34:1 clear	20:1 clear	20:1 clear <sup>6</sup>	20:1 clear <sup>6</sup>
ALP <sup>7</sup>	Required	Required	Required	Recommended
Minimum Runway Length	4,200 ft (paved)	3,200 ft <sup>8,9</sup>	3,200 ft <sup>8,9</sup>	3,200 ft <sup>8,9</sup>
Runway Markings (See AC 150/5340-1)	Precision	Non-precision <sup>9</sup>	Non-precision <sup>9</sup>	Visual (Basic) <sup>9</sup>
Holding Position Signs & Markings (See AC 150/5340-1, AC 150/5340-18)	Precision	Non-precision <sup>9</sup>	Non-precision <sup>9</sup>	Visual (Basic) <sup>9</sup>
Runway Edge Lights <sup>10</sup>	HIRL / MIRL	HIRL / MIRL	MIRL / LIRL	MIRL / LIRL (Required only for night minimums)
Parallel Taxiway <sup>11</sup>	Required	Required	Recommended	Recommended
Approach Lights <sup>12</sup>	MALS, SSALS, or ALSF	Recommended <sup>13</sup>	Recommended <sup>13</sup>	Not Required
Applicable Runway Design Standards, e.g. OFZ	< 3/4-statute mile approach visibility minimums	≥ 3/4-statute mile approach visibility minimums	≥ 3/4-statute mile approach visibility minimums	Not Required
Threshold Siting Criteria To Be Met (Reference paragraph 303)	Table 3-2, row 7	Table 3-2, row 6	Table 3-2, rows 1-5	Table 3-2, rows 1-4
Survey Required <sup>14</sup>	VGS	VGS (PA & APV)	NVGS <sup>15</sup>	NVGS <sup>16</sup>
		NVGS		

**Notes:**

1. Visibility minimums are subject to the application of Order 8260.3 ("TERPS"), and associated orders or this table, whichever is higher. To qualify for each visibility (or circling), all requirements within the same column must be met or exceeded.
2. All runways authorized for circling must meet threshold siting (reference paragraph 303), OFZ (reference paragraph 308), and TERPS Chapter 3, Section 3 criteria.
3. Height Above Airport (HAA) for circling. The HATh/HAA indicated is for planning purposes; actual obtainable HATh/HAA is determined by TERPS and may be higher due to obstacles or other requirements. HATh less than 250 ft must comply with requirements in < 3/4 statute mile column regardless of published visibility.
4. GQS is applicable to PA and APV only. See Table 3-2, row 8.
5. Applicable to PA only, as defined by paragraph 102. If not clear, HATh must be increased to 250 ft or greater (as required by TERPS).
6. If not clear, obstacles must be lighted (see AC 70/7460-1) or procedure/circling runway restricted to day only. In certain circumstance, a VGSI may be used in lieu of obstruction lighting as defined in TERPS.
7. An ALP is only required for obligated airports in the NPIAS; it is recommended for all others.
8. Runways less than 3,200 ft are protected by Part 77 to a lesser extent. However, runways as short as 2,400 ft could support an instrument approach provided the lowest HATh is based on clearing any 200-ft (61 m) obstacle within the final approach segment.
9. Unpaved runways require case-by-case evaluation by the RAPT.
10. Runway edge lighting is required for night approach minimums. High intensity lights are required for RVR-based minimums.
11. A full-length parallel taxiway must lead to the threshold.
12. To achieve lower visibility minimums based on credit for lighting, a full approach light system (ALSF-1, ALSF-2, SSALS, or MALS) is required for visibility < 3/4 statute mile. Intermediate (MALS, SSALS, SSALS, SALS/SALS) or Basic (ODALS) systems will result in higher visibility minimums. An ALSF-1 or ALSF-2 is required for CAT II/III ILS.
13. ODALS, MALS, SSALS, and SALS are acceptable.
14. See AC 150/5300-18 for Vertically Guided Survey (VGS) and non-Vertically Guided Survey (NVGS) requirements.
15. For PA and APV only, the NVGS must be supplemented with the first 10,200 ft of the Vertically Guided Approach Surface.
16. Absence of the indicated survey does not preclude authorization to establish circling to a runway but may result in increased HATh and visibility.



**318. Aircraft Rescue and Fire Fighting (ARFF) access.**

Access roads are normally needed to provide unimpeded two-way access for rescue and fire-fighting equipment to potential accident areas. Connecting these access roads, to the extent practical, with the operational surfaces and other roads will facilitate ARFF operations which, for the purposes of this AC, include mutual aid vehicles, ambulances, and any other emergency operations and equipment.

**a. Recommendation.** It is recommended that the entire RSA and RPZ be accessible to rescue and fire-fighting vehicles such that no part of the RSA or RPZ is more than 330 feet (100 m) from either an all-weather road or a paved operational surface. Where an airport is adjacent to a body of water where access by rescue personnel from airport property is desirable, it is recommended that boat launch ramps with appropriate access roads be provided.

**b. Road design.** ARFF access roads are all weather roads designed to support rescue and fire-fighting equipment traveling at normal response speeds. Establish the widths of the access roads considering the type(s) of rescue and fire-fighting equipment available and planned at the airport. Use large radius turns to permit high center-of-gravity vehicles to maintain high speeds. To prevent vehicle tires from tracking foreign object debris (FOD) onto runways and taxiways, the first 300 feet (91 m) adjacent to a paved operational surface should be paved. Where an access road crosses a safety area, use the safety area standards for smoothness and grading control. For other design and construction features, use local highway specifications.

**c. Road usage.** ARFF access roads are special purpose roads that supplement but do not duplicate or replace sections of a multi-purpose road system. Restricting their use to rescue and fire-fighting access equipment precludes their being a hazard to air navigation.

**319. Jet blast.**

Jet blast can cause erosion along runway shoulders. Special considerations are needed for shoulders, blast pads, and in some cases blast fences. Refer to [Appendix 3](#) for information on the effects and treatment of jet blast.

**320. Runway design requirements matrix.**

**a. Separation standards.** Runway design and separation standards are presented in interactive [Table 3-5](#). The dimensional standards, and corresponding letters, for a typical airport layout are shown in [Figure 3-26](#). The separation distances may need to be increased with airport elevation to meet the ROFZ standards.

(1) Runway to holdline. The required runway to holdline separation is derived from landing and takeoff flight path profiles and the physical characteristics of aircraft. Additional holdlines may be required to prevent aircraft from interfering with the ILS LOC and GS operations.

(2) Runway to taxiway. Interactive [Table 3-5](#) provides the minimum runway to taxiway separation standards based on Airplane Design Group. These standards are determined by landing and takeoff flight path profiles and physical characteristics of aircraft. Note, however, that the dimensions in interactive [Table 3-5](#) assume the same design aircraft for the runway and taxiway. If a taxiway serves larger aircraft (e.g. air carrier aircraft taxiing between the terminal and another runway), the runway to taxiway separation distance is based on the ADG of the larger aircraft. Also, if there is a need for direction reversal between the runway and the parallel taxiway when using a high-speed exit, it is necessary to use [Table 3-6](#), which provides the minimum and recommended separation distances between a runway and parallel taxiway and runways for such turns based on Taxiway Design Group. In that case, use the greater value from interactive [Table 3-5](#) and [Table 3-6](#). See paragraph [409.c](#) for additional information on the effect of exit taxiway design on runway/taxiway separation.

(3) Runway to aircraft parking area. Runway to aircraft parking area separation is determined by the landing and takeoff flight path profiles and physical characteristics of aircraft. The runway to parking area separation standard precludes any part of a parked aircraft (tail, wingtip, nose, etc.) from being within the ROFA or penetrating the OFZ.

**321. On-airport farming.**

Where such use is permitted, crops and machinery are subject to all airport design criteria, including horizontal and vertical clearances associated with runways, taxiways/taxilanes, and aprons. In addition, see [AC 150/5200-33](#).

**Table 3-5. Runway design standards matrix**

*Aircraft Approach Category (AAC) and  
Airplane Design Group (ADG):  
(select from pull-down menu at right)*

ITEM	DIM <sup>1</sup>	Visibility Minimums			
		Visual	Not Lower than 1 mile	Not Lower than 3/4 mile	Lower than 3/4 mile
<b>Runway Design</b>					
Runway Length	A	Refer to paragraphs 302 and 304			
Runway Width	B				
Shoulder Width					
Blast Pad Width					
Blast Pad Length					
Crosswind Component					
<b>Runway Protection</b>					
Runway Safety Area (RSA)					
Length beyond departure end	R				
Length prior to threshold	P				
Width	C				
Runway Object Free Area (ROFA)					
Length beyond runway end	R				
Length prior to threshold	P				
Width	Q				
Runway Obstacle Free Zone (ROFZ)					
Length		Refer to paragraph 308			
Width		Refer to paragraph 308			
Precision Obstacle Free Zone (POFZ)					
Length					
Width					
Approach Runway Protection Zone (RPZ)					
Length	L				
Inner Width	U				
Outer Width	V				
Acres					
Departure Runway Protection Zone (RPZ)					
Length	L				
Inner Width	U				
Outer Width	V				
Acres					
<b>Runway Separation</b>					
<i>Runway centerline to:</i>					
Parallel runway centerline	H	Refer to paragraph 316			
Holding position					
Parallel Taxiway/Taxilane centerline	D				
Aircraft parking area	G				
Helicopter touchdown pad		Refer to AC 150/5390-2			

**Notes:**

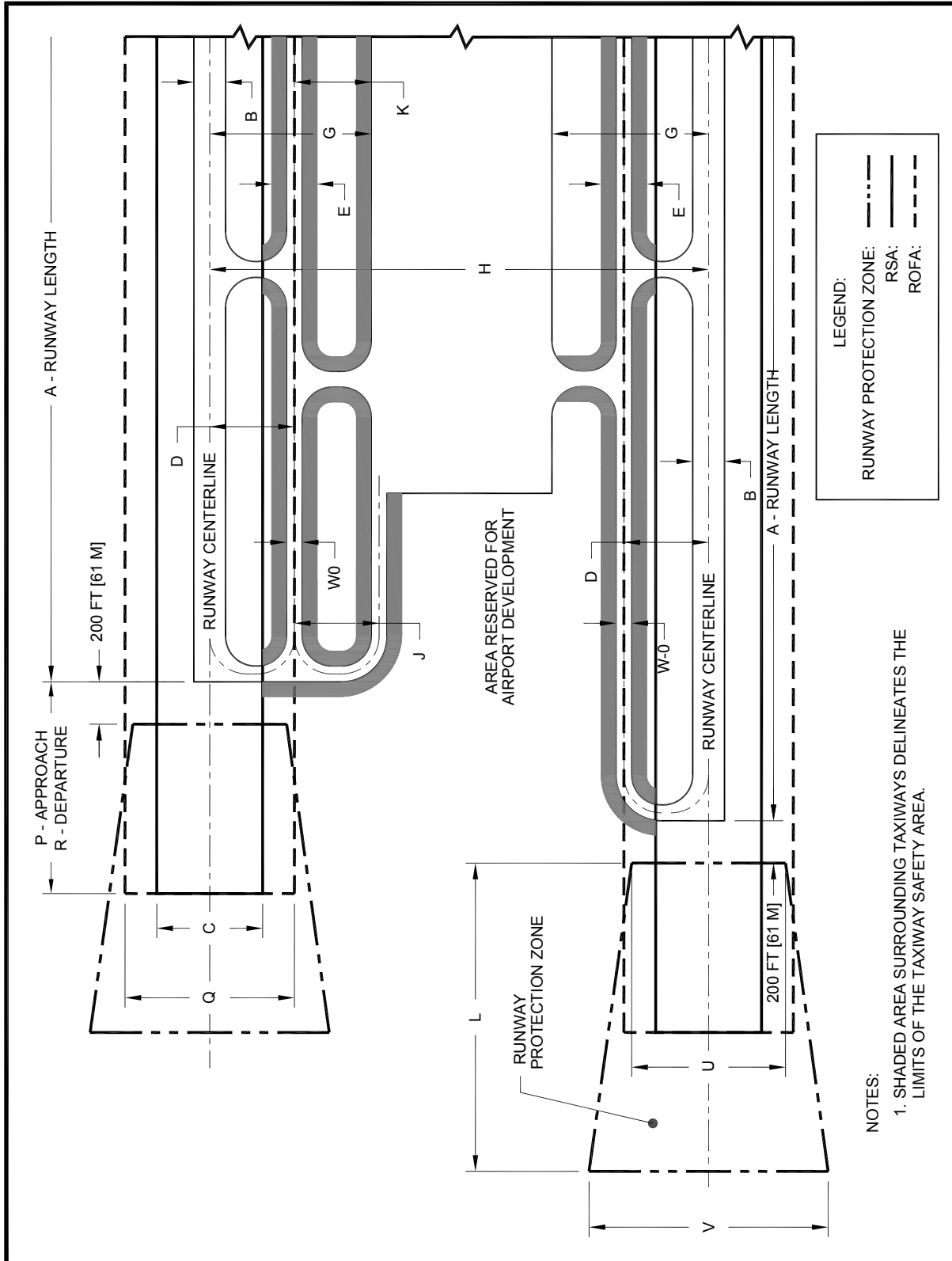
- Appendix 7 contains non-interactive tables for all RDCs.
- Values in the table are rounded to the nearest foot. 1 foot = 0.305 meters.

**Footnotes:**

1. Letters correspond to the dimensions in Figure 3-26.
2. The runway to taxiway/taxilane centerline separation standards are for sea level. At higher elevations, an increase to these separation distances may be required to keep taxiing and holding aircraft clear of the inner-transitional OFZ (refer to paragraph 308.c). Using this standard to justify a decrease in runway to taxiway/taxilane separation is not permitted.
3. The standard runway centerline to parallel taxiway centerline separation distance is 400 feet for airports at or below an elevation of 1,345 feet; 450 feet for airports between elevations of 1,345 feet and 6,560 feet; and 500 feet for airports above an elevation of 6,560 feet.
4. For approaches with visibility less than ½-statute mile, runway centerline to taxiway/taxilane centerline separation increases to 400 feet.
5. For approaches with visibility less than ½-statute mile, the separation distance increases to 500 feet.
6. For approaches with visibility less than ¾ statute mile, the separation distance may increase by an elevation adjustment. For approaches with visibility less than ½-statute mile, the separation distance increases to 550 feet.
7. This distance is increased 1 foot for each 100 feet above 5,100 feet above sea level.
8. This distance is increased 1 foot for each 100 feet above sea level.
9. The RSA length beyond the runway end begins at the runway end when a stopway is not provided. When a stopway is provided, the length begins at the stopway end.
10. The RSA length beyond the runway end may be reduced to that required to install an Engineered Materials Arresting System (EMAS) (the designed set-back of the EMAS included) designed to stop the design aircraft exiting the runway end at 70 knots.
11. This value only applies if that runway end is equipped with electronic or visual vertical guidance. If visual guidance is not provided, use the value for “length beyond departure end.”
12. For airplanes with maximum certificated takeoff weight of 150,000 lbs or less, the standard runway width is 100 feet, the shoulder width is 20 feet, and the runway blast pad width is 140 feet.
13. An RSA width of 400 feet is permissible.

**Table 3-6. Runway to taxiway separation for reverse turns from a high-speed exit based on Taxiway Design Group (TDG)**

	TDG						
	1	2	3	4	5	6	7
Runway centerline to taxiway/ taxilane centerline – minimum	250 ft (76 m)	265 ft (81 m)	350 ft (107 m)	427 ft (130 m)	427 ft (130 m)	484 ft (148 m)	484 ft (148 m)
Runway centerline to taxiway/ taxilane centerline - recommended	250 ft (76 m)	300 ft (91 m)	350 ft (107 m)	450 ft (137 m)	450 ft (137 m)	600 ft (183 m)	600 ft (183 m)



Note: Dimension letters are keyed to interactive [Table 3-5](#), [Table 4-1](#) and [Table 4-2](#).

**Figure 3-26. Typical airport layout**

### 322. Declared distances.

**a. Application.** Declared distances represent the maximum distances available and suitable for meeting takeoff, rejected takeoff, and landing distances performance requirements for turbine powered aircraft. The declared distances are TORA and TODA, which apply to takeoff; Accelerate Stop Distance Available (ASDA), which applies to a rejected takeoff; and Landing Distance Available (LDA), which applies to landing. A clearway may be included as part of the TODA, and a stopway may be included as part of the ASDA. By treating these distances independently, declared distances is a design methodology that results in declaring and reporting the TORA, TODA ASDA and LDA for each operational direction.

(1) Declared distances may be used to obtain additional RSA and/or ROFA prior to the runway's threshold (the start of the LDA) and/or beyond the stop end of the LDA and ASDA, to mitigate unacceptable incompatible land uses in the RPZ, to meet runway approach and/or departure surface clearance requirements, in accordance with airport design standards, or to mitigate environmental impacts. Declared distances may also be used as an incremental improvement technique when it is not practical to fully meet these requirements. However, declared distances may only be used for these purposes where it is impracticable to meet the airport design standards or mitigate the environmental impacts by other means, and the use of declared distances is practical.

(2) Declared distances may limit or increase runway use. The use of declared distances may result in a displaced runway threshold, and may affect the beginning and ending of the RSA, ROFA, and RPZ. For runways without published declared distances, the declared distances are equal to the physical length of the runway unless there is a displaced threshold. In such a case, the LDA is shortened by the length of the threshold displacement.

(3) Declared distances that are not equal to the physical length of the runway are discussed in the remainder of this section and must be approved by the FAA. Except when a stopway exists as part of the ASDA, the LDA ends at the same location as the end of the ASDA. A stopway cannot be part of the LDA. Note that except for the case of a landing to a displaced threshold, an aircraft is not prohibited from occupying any portion of the runway.

**b. RSA, ROFA, and RPZ lengths and related nomenclature.** The nomenclature referenced in the following paragraphs is used throughout the rest of this section and is always based upon the direction of operation.

(1) RSA, ROFA standards. The length "R" is specified in interactive [Table 3-5](#) as the required length of the RSA and ROFA beyond the runway departure end. The length "P" is specified in interactive [Table 3-5](#) as the required length of the RSA and ROFA prior to the threshold. A full dimension RSA and full dimension ROFA extend the length of the runway plus  $2 \times R$  when there is no stopway. Where a stopway exists, R is measured from the far end of the stopway based upon the takeoff direction, and the RSA and ROFA extend the full length of the runway plus the length of the stopway(s) plus  $2 \times R$ .

(2) Existing or proposed RSA and ROFA beyond the runway ends. As used in the [Figure 3-34](#), [Figure 3-35](#), [Figure 3-36](#), [Figure 3-37](#), [Figure 3-38](#), [Figure 3-41](#), and [Figure](#)

3-42, the RSA length “S” is the existing or proposed RSA beyond the runway ends. The ROFA length “T” is the existing or proposed ROFA beyond the runway ends.

**(3)** RPZ Lengths. The standard RPZ length “L” is the length specified in interactive Table 3-5 for both the Approach RPZ, which ends 200 ft (61 m) from the threshold based upon the landing direction, and the Departure RPZ, which begins 200 ft (61 m) from the runway end based upon the direction of takeoff. See Figure 3-16, Figure 3-17, and Figure 3-18.

**c. Background.** In applying declared distances in airport design, it is helpful to understand the relationship between aircraft certification, aircraft operating rules, airport data, and airport design. Aircraft certification provides the aircraft’s performance distances.

**(1)** The takeoff decision speed ( $V_1$ ), and the following distances to achieve or decelerate from  $V_1$  are established by the manufacturer and confirmed during certification testing for varying climatological conditions, operating weights, etc.:

(a) Takeoff run — the distance to accelerate from brake release to lift-off, plus safety factors. (See TORA, paragraph 322.d(1).)

(b) Takeoff distance — the distance to accelerate from brake release past lift-off to start of takeoff climb, plus safety factors. (See TODA, paragraph 322.d(2).)

(c) Accelerate-stop distance — the distance to accelerate from brake release to  $V_1$  and then decelerate to a stop, plus safety factors. (See ASDA, paragraph 322.d(3).)

(d) Landing distance — the distance from the threshold to complete the approach, touchdown, and decelerate to a stop, plus safety factors. (See LDA, paragraph 322.e(1).)

**(2)** Aircraft operating rules provide a minimum acceptable level of safety by controlling the aircraft maximum operating weights and limiting the aircraft’s performance distances as follows:

(a) TORA must not exceed the length of runway.

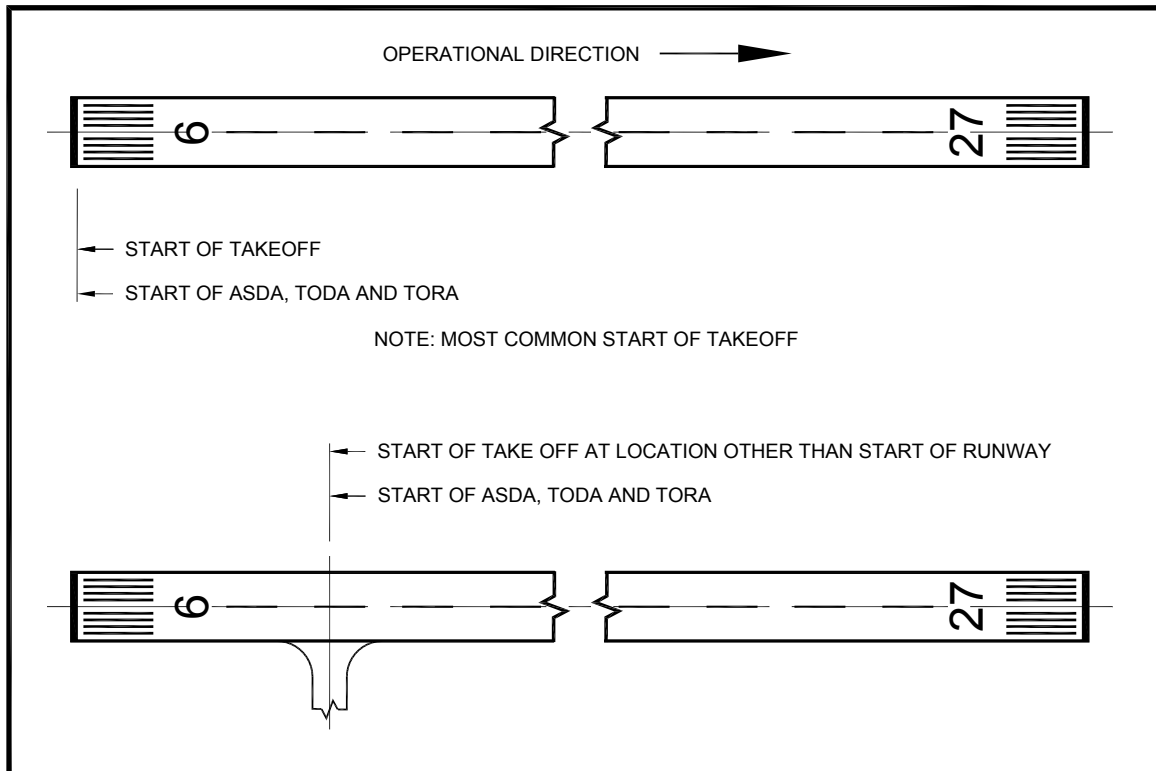
(b) TODA must not exceed the length of runway plus clearway.

(c) ASDA must not exceed the length of runway plus stopway.

(d) LDA must not exceed the length of runway.

**(3)** Airport data provide the runway length and/or the following declared distance information for calculating maximum operating weights and/or operating capability.

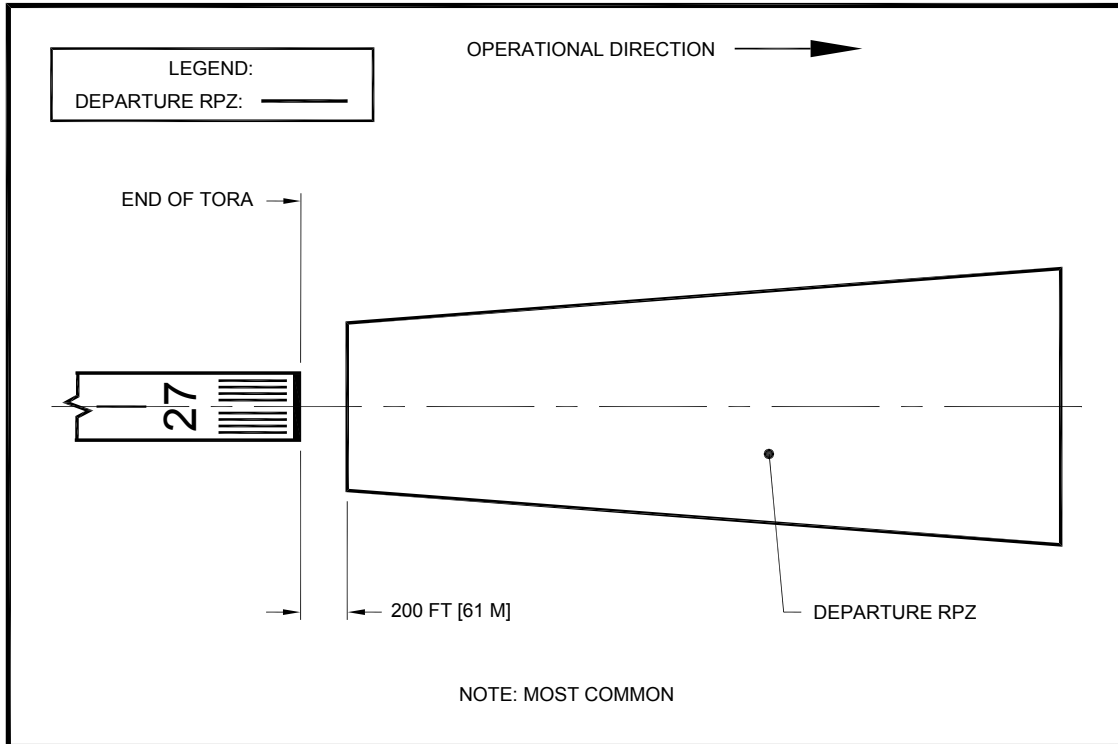
**d. For takeoff.** Start of takeoff ends of runway: The start of takeoff for ASDA, TORA and TODA will always be collocated. Neither, the threshold locations, the RPZs, nor the RSA and ROFA behind the start of takeoff, are considered in establishing the start of takeoff. The start of takeoff is most often at the beginning of the runway, but may also be located farther up the runway (see [Figure 3-27](#)). When TODA, ASDA and TORA are declared starting at such a location, start of takeoff may not start behind that point.



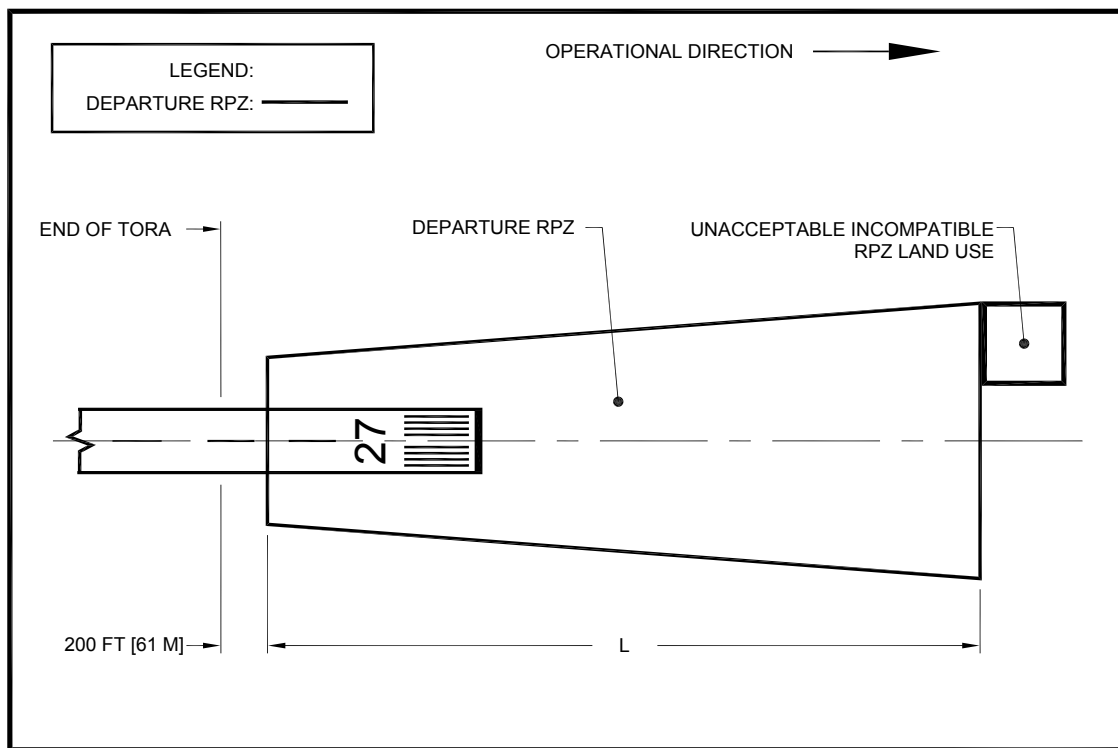
**Figure 3-27. Location of start of Accelerate-Stop Distance Available (ASDA), TODA, and TORA**

(1) TORA — the length of runway declared available and suitable for satisfying takeoff run requirements. The start of takeoff, the departure RPZ, and limitations resulting from a reduced TODA are to be considered in determining the TORA. When the full runway beyond the start of takeoff is available for the takeoff run, the departure end of the TORA is located at the end of the runway (see [Figure 3-28](#)). The TORA may be reduced such that it ends prior to the runway to resolve incompatible land uses in the departure RPZ, and/or to mitigate environmental effects. The departure RPZ begins 200 ft (61 m) from the end of the TORA and extends out a distance L (see [Figure 3-28](#) and [Figure 3-29](#)). Since TORA can never be longer than the TODA, whenever the TODA is shortened to less than the runway length to mitigate penetrations to the departure surface, the TORA is limited to the length of the TODA (see [Figure 3-30](#)). Additionally, if a clearway exists and it begins prior to the runway end, the TORA ends at the beginning of the clearway (see [Figure 3-31](#)).

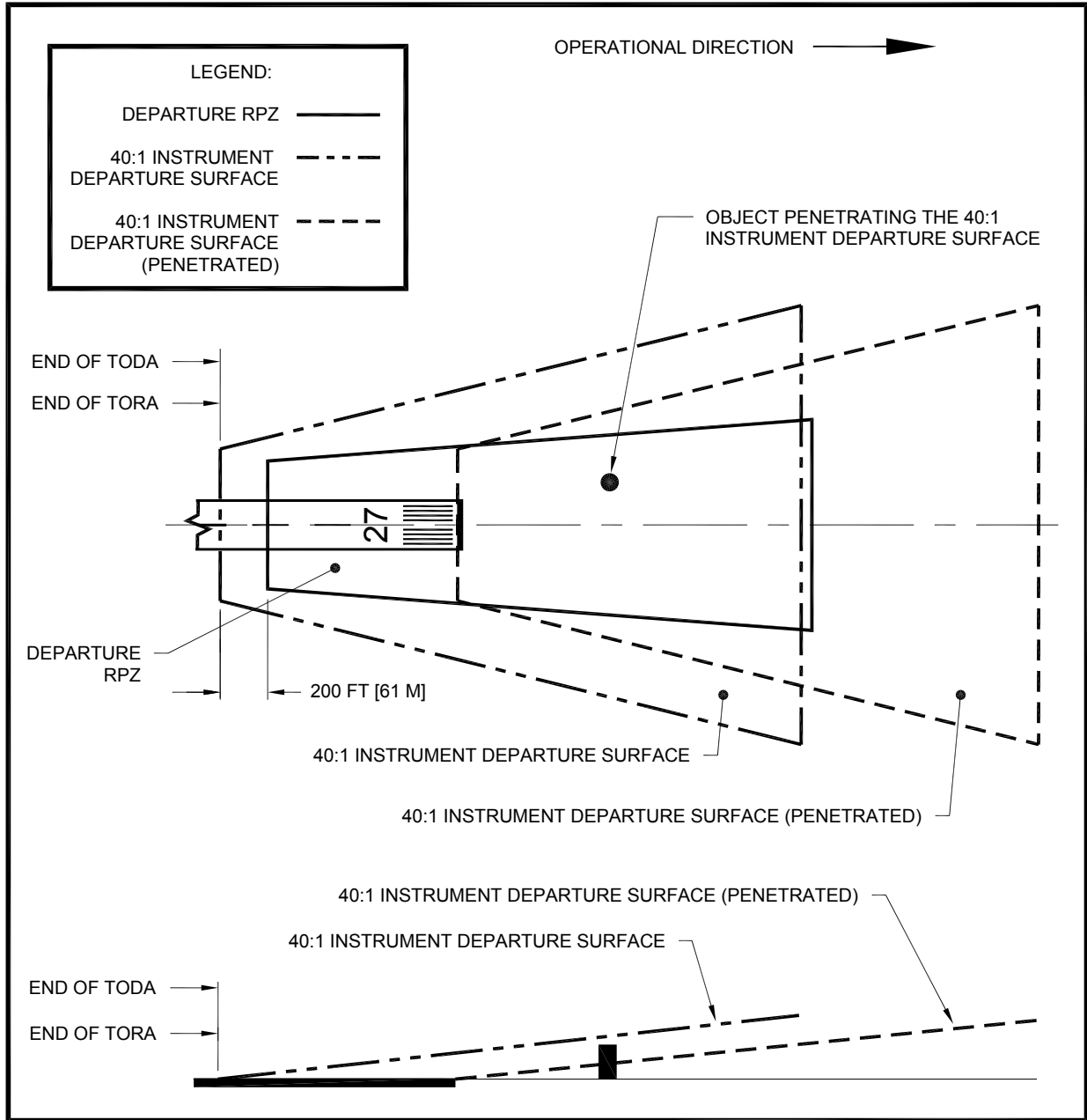




**Figure 3-28. Normal location of departure end of TORA**



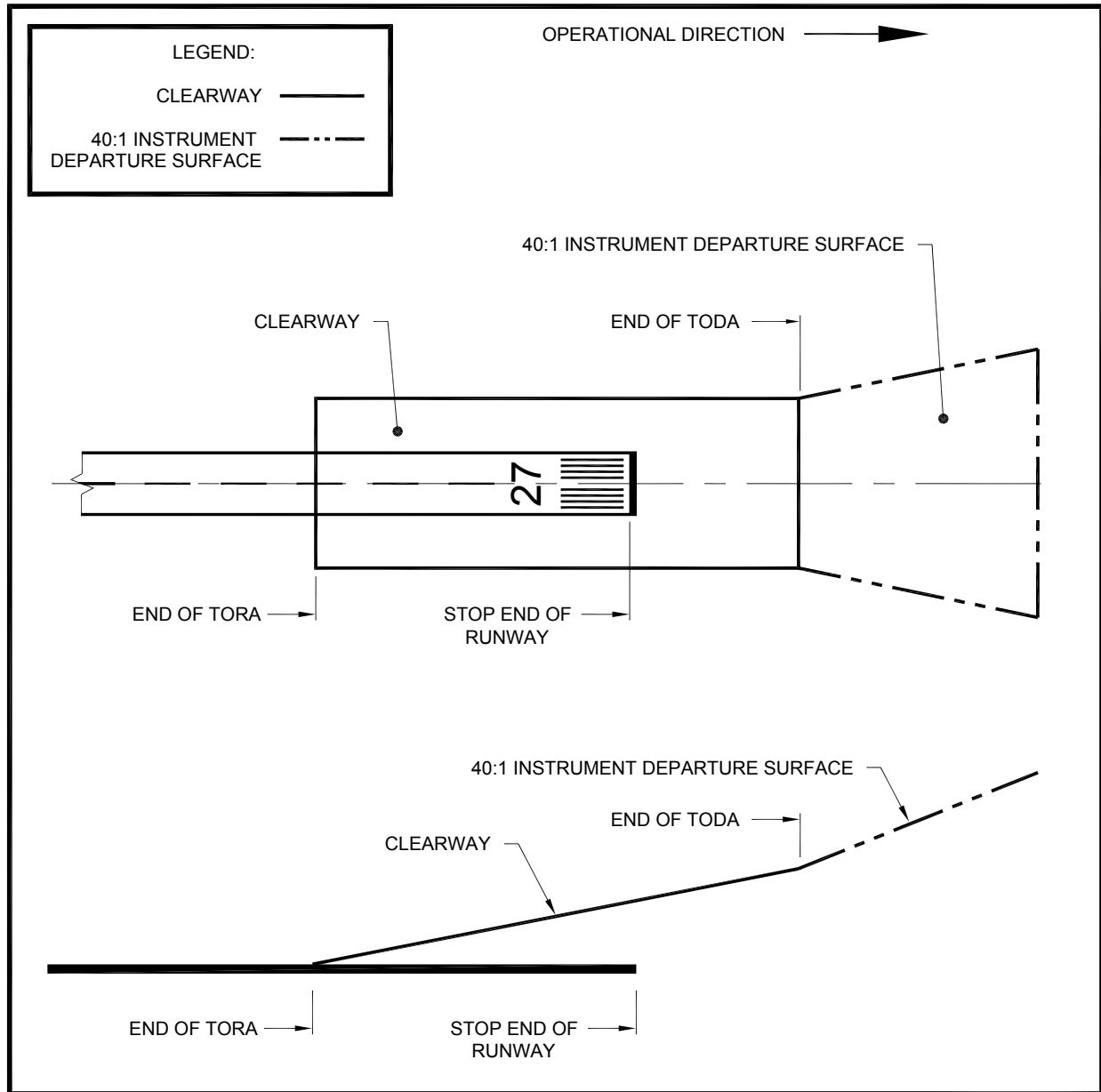
**Figure 3-29. Departure end of TORA based on departure RPZ located to mitigate unacceptable incompatible land use**



**Notes:**

1. The penetration to the instrument departure surface has been mitigated by the decreased length of the TODA.
2. TORA has been limited by TODA. TORA can never be longer than TODA.

**Figure 3-30. TODA shortened to mitigate penetration to the departure surface resulting in shortened TORA**

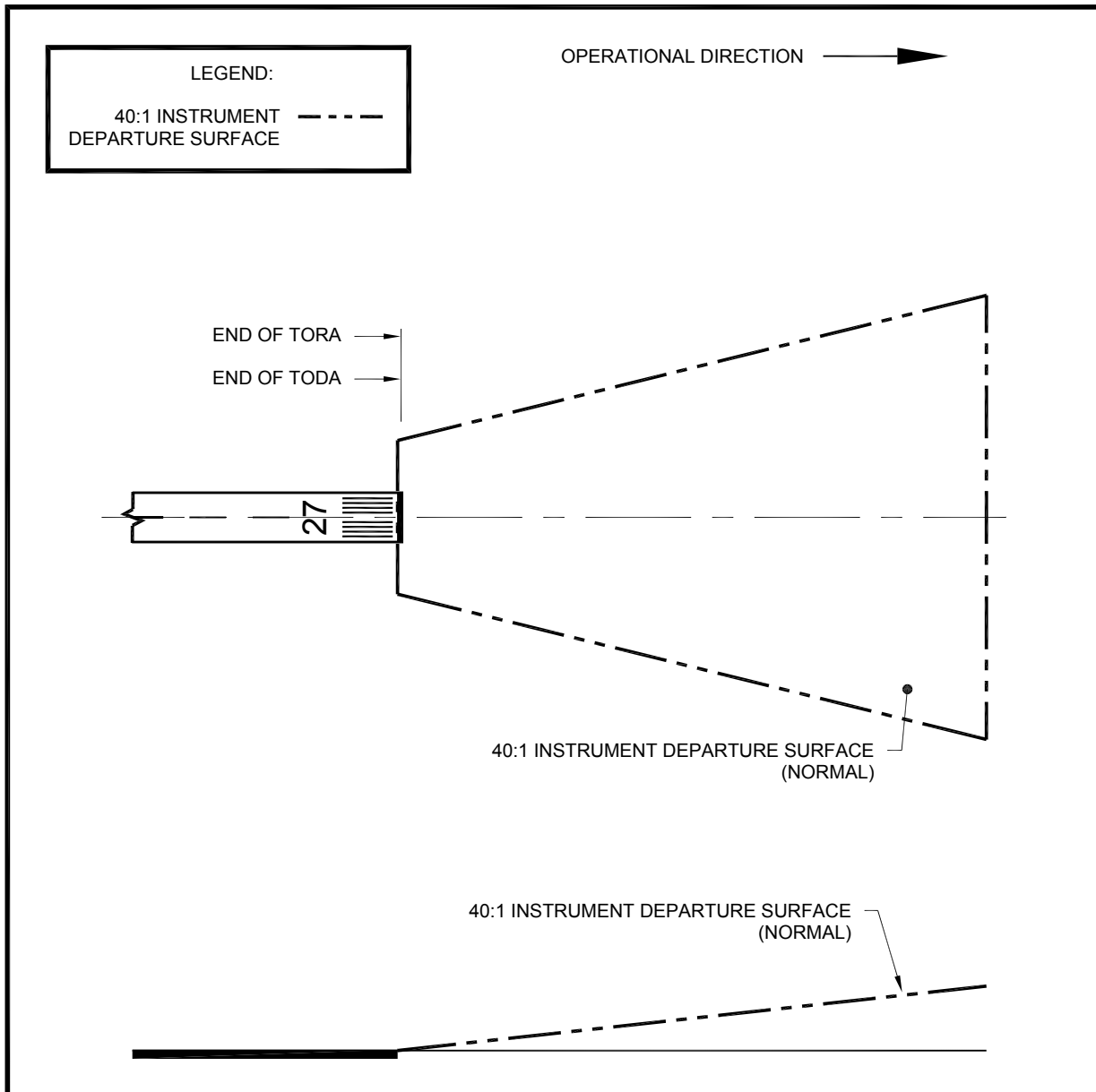


**Figure 3-31. TODA extended by use of a clearway, shortened TORA**

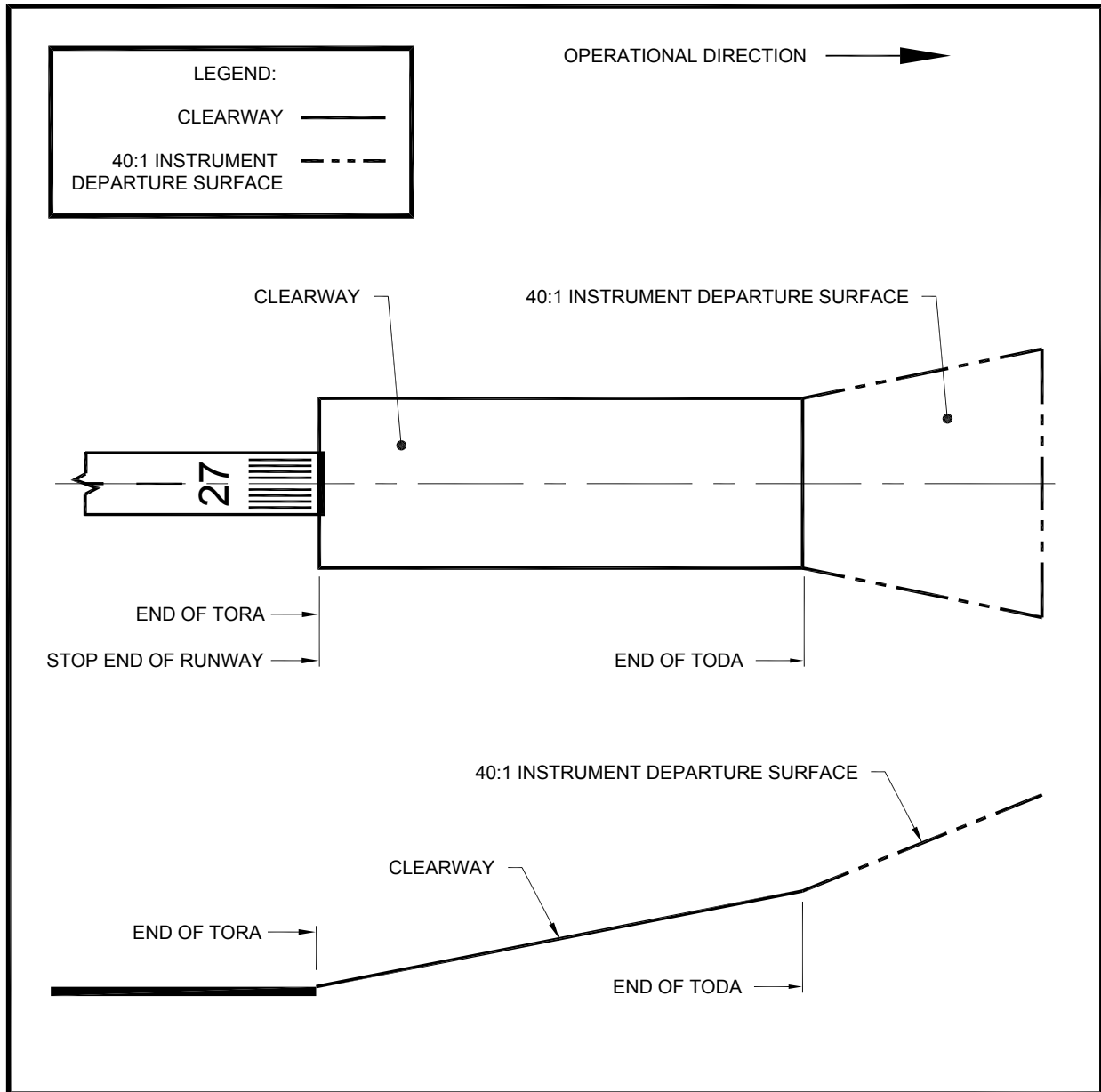
**(2) TODA.**

(a) General. The TORA plus the length of any remaining runway or clearway beyond the departure end of the TORA available for satisfying takeoff distance requirements. The start of takeoff, departure surface requirements, and any clearway are considered in determining the TODA. When only the full runway beyond the start of takeoff is available for takeoff distance, the departure end of the TODA is located at the end of the runway (see [Figure 3-32](#)). The TODA may be limited from extending to the runway end to mitigate penetrations to the 40:1 instrument departure surface (where applicable). (See [Figure 3-30](#).)

This is only one method of mitigating penetrations to the departure surface. The TODA may also extend beyond the runway end through the use of a clearway (see [Figure 3-31](#) and [Figure 3-33](#)). The full length of the TODA may not be usable for a particular operation, and may be limited by obstacles in the departure area and aircraft performance. As such, the usable TODA length is determined by the aircraft operator before each takeoff and requires knowledge of each controlling obstacle in the departure area.



**Figure 3-32. Normal location of departure end of TODA (no clearway)**



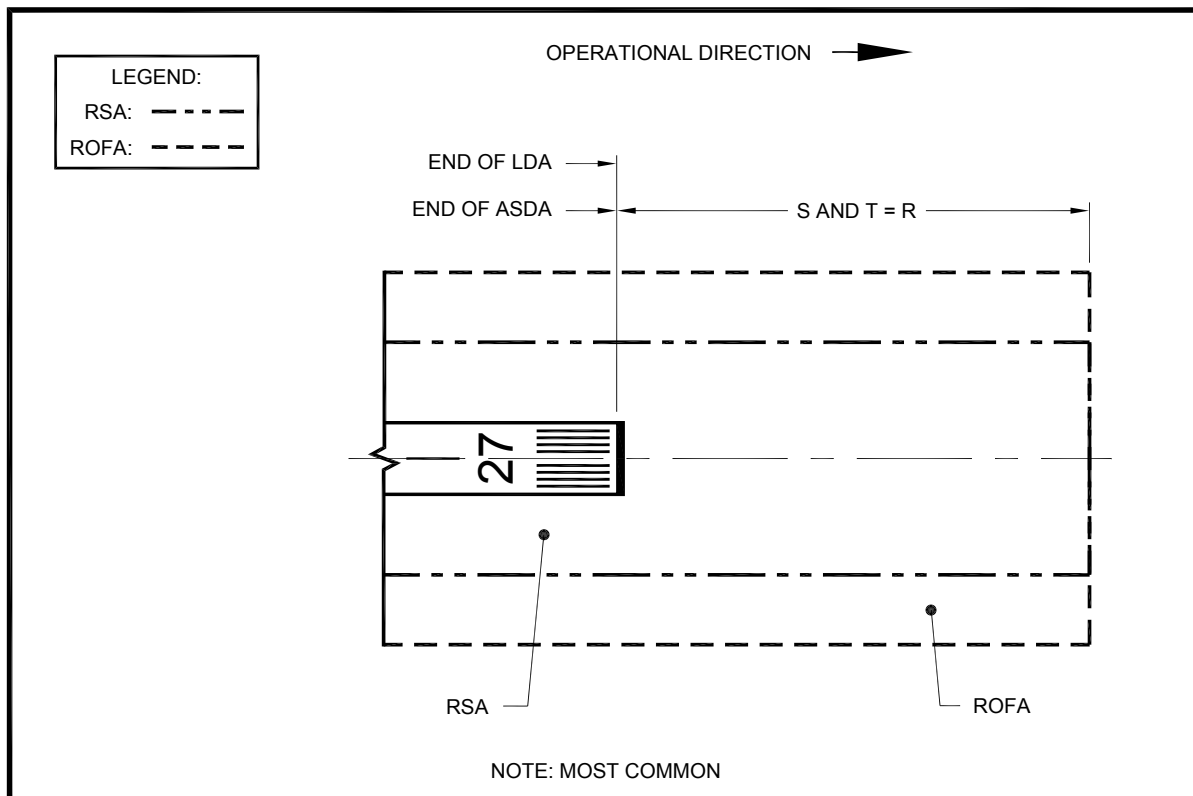
**Figure 3-33. TODA extended by use of a clearway, normal TORA**

(b) Clearway. A clearway may only be included as part of TODA. It is located at the departure end of the TORA. When the TORA does not extend to the end of the runway a clearway (if any) must extend beyond the runway end. Any portion of the runway extending into the clearway is unavailable and/or unsuitable for takeoff run and takeoff distance computations. However, the length of the clearway is added to the TORA for takeoff distance calculations. A clearway increases the allowable airplane operating takeoff weight without increasing runway length. See paragraph [311](#).

**(3) ASDA.**

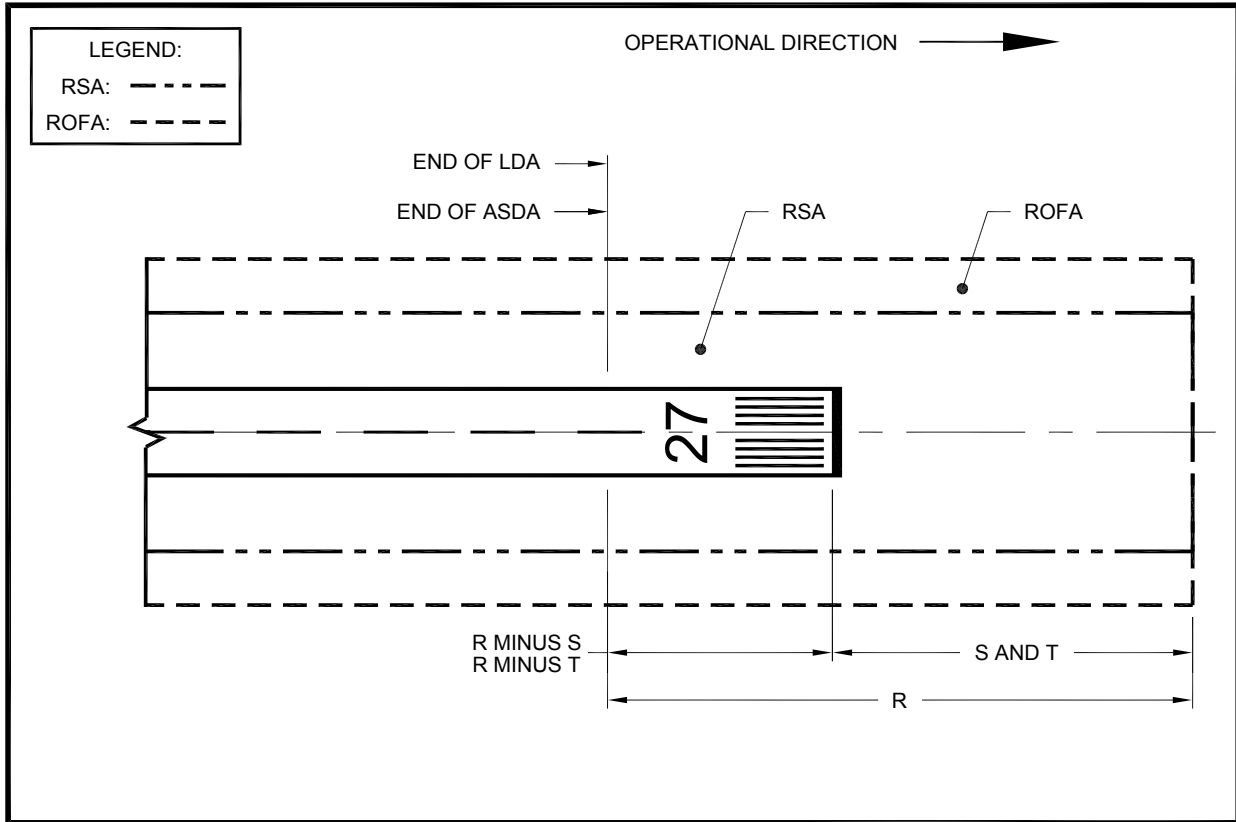
(a) General. The ASDA extends the length of runway plus stopway (if any) declared available and suitable for satisfying accelerate-stop distance requirements for a rejected takeoff. At the start of takeoff, the RSA and ROFA beyond the ASDA are considered in determining the ASDA. When only the full runway beyond the start of takeoff is available for completing a rejected takeoff, the stop end of the ASDA is located at the end of the runway, with the standard RSA and ROFA length  $R$  beyond the runway end (see [Figure 3-34](#)). When the standard RSA length  $R$  beyond the end of the runway is not obtainable, additional RSA may be obtained beyond the ASDA by reducing the ASDA as illustrated in [Figure 3-35](#). Where it has been decided that declared distances will also be used to provide ROFA not obtainable beyond the runway end and  $T$  is less than  $S$ , additional ROFA and RSA beyond the ASDA may be obtained by reducing the ASDA as illustrated in [Figure 3-36](#). When a runway includes a stopway, the RSA and ROFA extend  $R$  beyond the stopway (see [Figure 3-37](#)). It may be necessary to use EMAS in conjunction with declared distances. The portion of runway beyond the ASDA is unavailable and/or unsuitable for ASDA computations.

(b) Stopway. A stopway may only be included as part of ASDA. See the definition of a stopway in paragraph [102.zzz](#).

**Notes:**

1. When a stopway exists, see [Figure 3-37](#) for the stop end of the ASDA.
2.  $S$  denotes the existing or proposed length of the RSA beyond the runway end.
3.  $T$  denotes the existing or proposed length of the ROFA beyond the runway end.

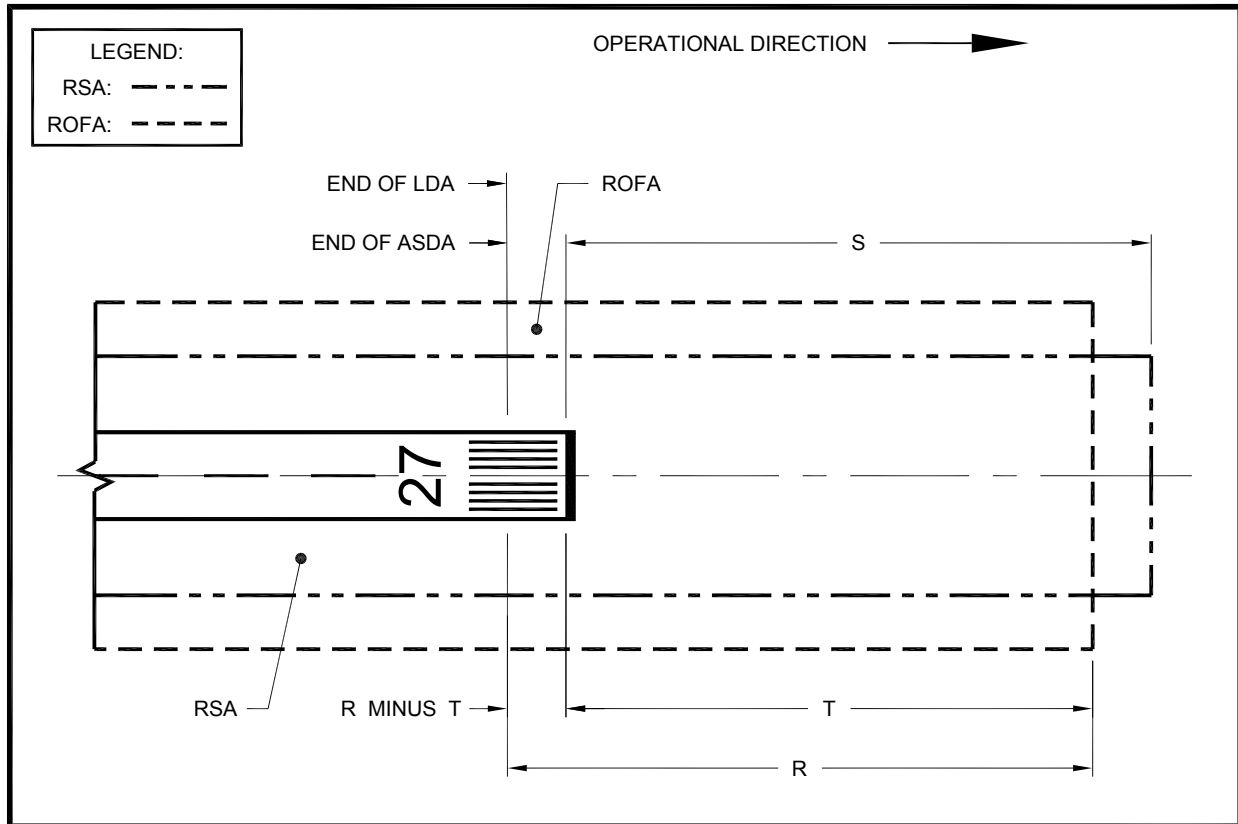
**Figure 3-34. Normal location of stop end of ASDA and Landing Distance Available (LDA)**



**Notes:**

1. When a stopway exists, see [Figure 3-37](#) for the stop end of the ASDA.
2. S denotes the existing or proposed length of the RSA beyond the runway end.
3. T denotes the existing or proposed length of the ROFA beyond the runway end.
4. When declared distances are used as an incremental improvement and R is not obtainable beyond the LDA, this dimension may equal the length of RSA obtainable beyond the ASDA.
5. When declared distances are used as an incremental improvement and R is not obtainable beyond the LDA/ASDA, this dimension may equal the length of RSA obtainable beyond the LDA/ASDA minus S.

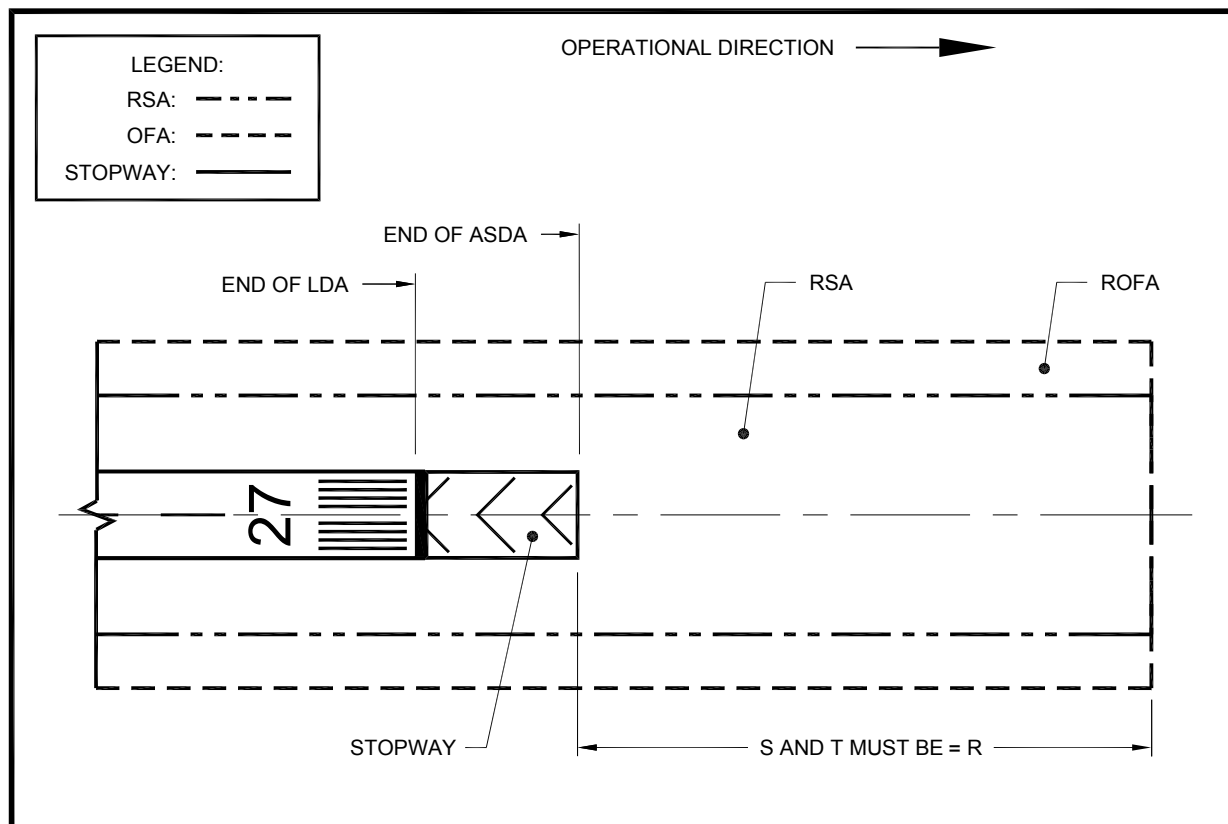
**Figure 3-35. Stop end of ASDA and LDA located to provide additional RSA**

**Notes:**

1. When a stopway exists, see [Figure 3-37](#) for the stop end of the ASDA.
2. S denotes the existing or proposed length of the RSA beyond the runway end.
3. T denotes the existing or proposed length of the ROFA beyond the runway end.
4. When declared distances are used as an incremental improvement and R is not obtainable beyond the LDA/ASDA, this dimension may equal the length of ROFA obtainable beyond the LDA/ASDA.
5. When declared distances are used as an incremental improvement and R is not obtainable beyond the LDA/ASDA, this dimension may equal the length of ROFA obtainable beyond the LDA/ASDA minus T.

**Figure 3-36. Stop end of ASDA and LDA located to provide additional Runway Object Free Area (ROFA)**



**Notes:**

1. S denotes the existing or proposed length of the RSA beyond the runway end.
2. T denotes the existing or proposed length of the ROFA beyond the runway end.

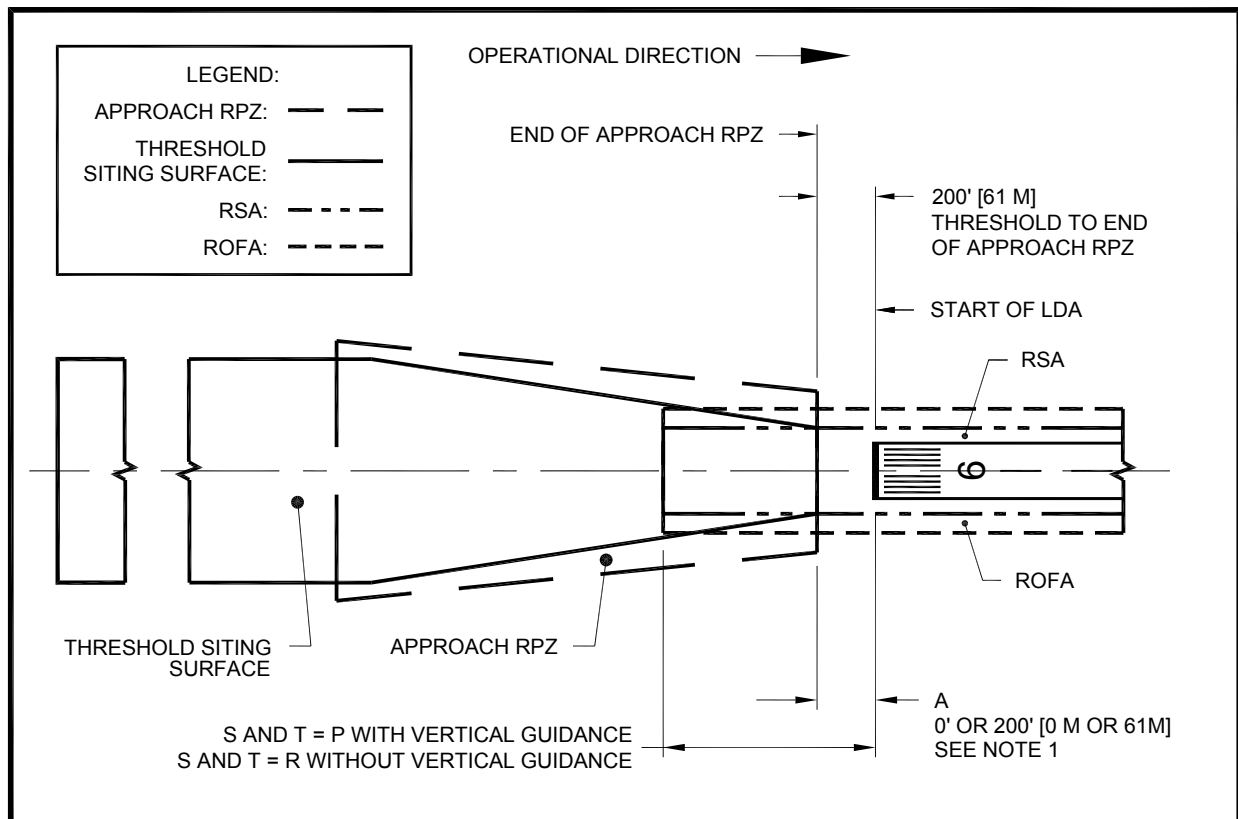
**Figure 3-37. Stop end of ASDA located based on use of a stopway**

**e. For landing.**

(1) LDA — the length of runway declared available and suitable for satisfying landing distance requirements. The threshold siting criteria, the approach RPZ, the RSA and ROFA prior to the threshold and beyond the LDA are considerations in establishing this distance.

(a) The beginning of the LDA. The LDA begins at the threshold. When the RSA, ROFA, approach RPZ and threshold siting requirements are met the threshold is normally placed at the beginning of the runway. (See [Figure 3-38](#)). When these requirements are not met the threshold may be displaced. When there are multiple reasons to displace a threshold, each displacement requirement is calculated. The longest displacement is selected. All other criteria are then reevaluated from the calculated threshold location to ensure that they are not violated, such as new obstacle penetrations due to the splay of the approach surface that is associated with the new threshold. The threshold may be displaced to obtain additional RSA and ROFA, to mitigate unacceptable incompatible land uses in the RPZ, to meet approach surface requirements, and to mitigate environmental effects (see [Figure 3-38](#), [Figure 3-39](#), [Figure 3-40](#), [Figure 3-41](#) and [Figure 3-42](#)).

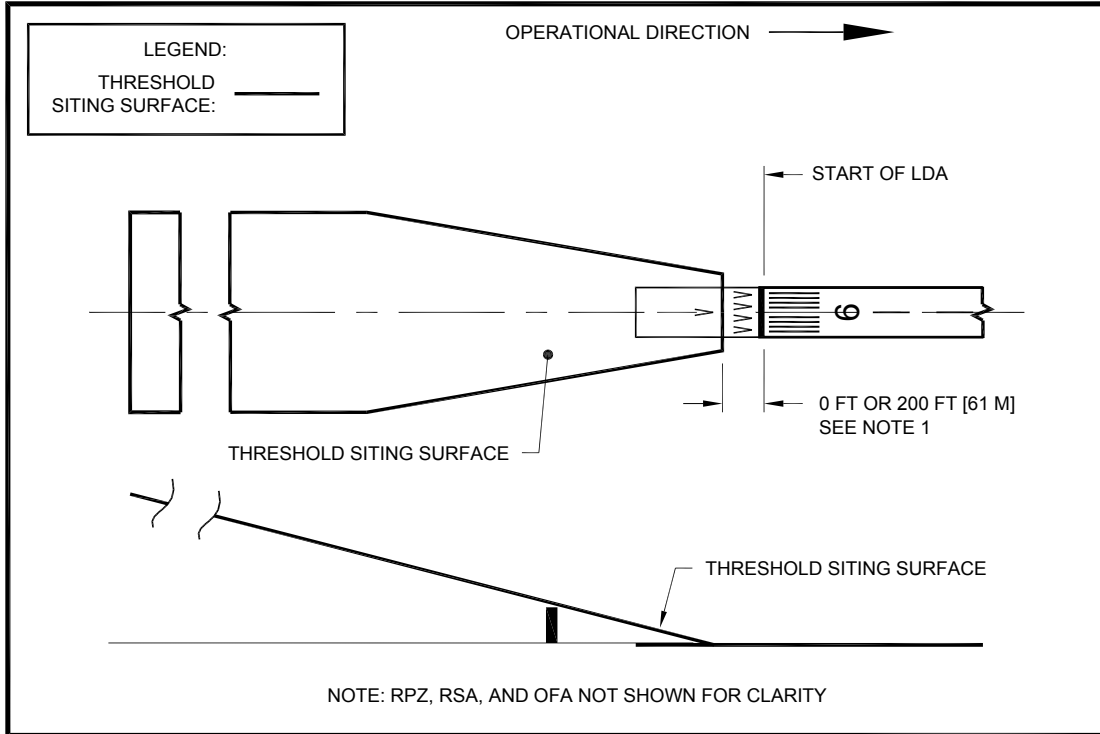
(b) The end of the LDA. When the LDA extends to the end of the runway, the full dimension RSA and ROFA extend beyond the runway end by length R. Except when a stopway exists as part of the ASDA, the LDA ends at the same location as the end of the ASDA. A stopway cannot be part of the LDA. When the full dimension RSA/ROFA length R beyond the runway end is not obtainable, additional RSA may be obtained beyond the LDA by reducing the LDA as illustrated in [Figure 3-35](#). Where it has been decided that declared distances will also be used to provide ROFA not obtainable beyond the runway end and T is less than S, additional RSA ROFA beyond the LDA may be obtained by reducing the LDA as illustrated by [Figure 3-36](#). EMAS may also be used to meet RSA standards. It may be necessary to use EMAS in conjunction with declared distances. The portion of runway beyond the LDA is unavailable for LDA computations (see [Figure 3-35](#) and [Figure 3-36](#)).



**Notes:**

1. See [Table 3-2](#).
2. S denotes the existing or proposed length of the RSA beyond the runway end.
3. T denotes the existing or proposed length of the ROFA beyond the runway end.

**Figure 3-38. Normal start of LDA**



Note: See Table 3-2.

Figure 3-39. Start of LDA at displaced threshold based on Threshold Siting Surface (TSS)

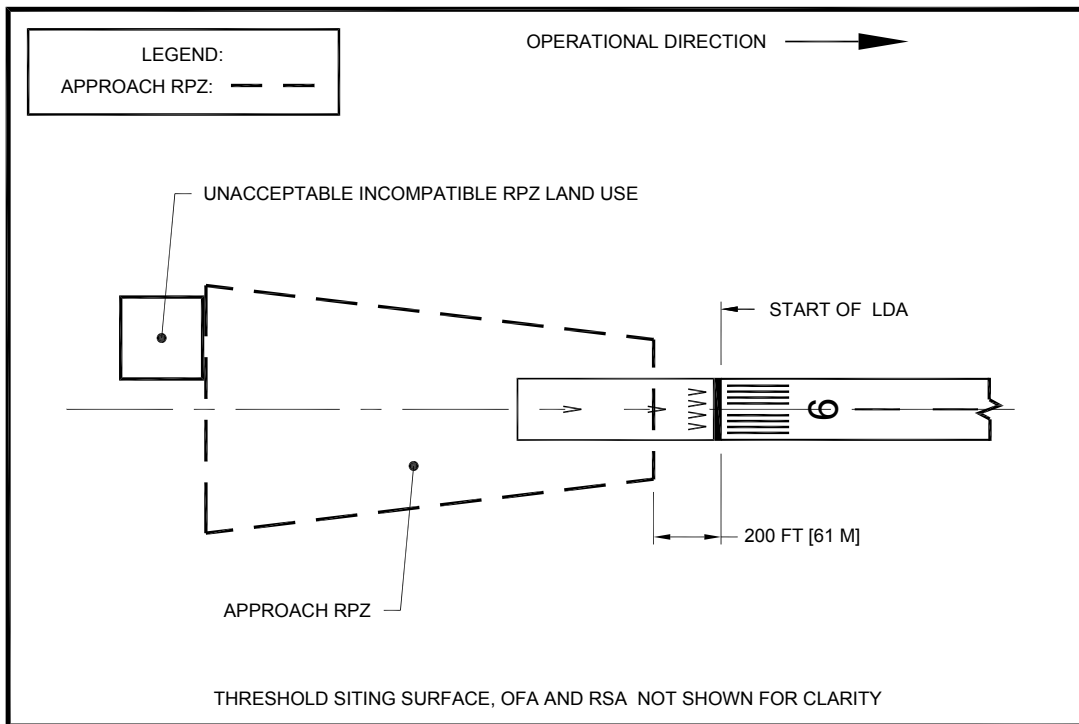
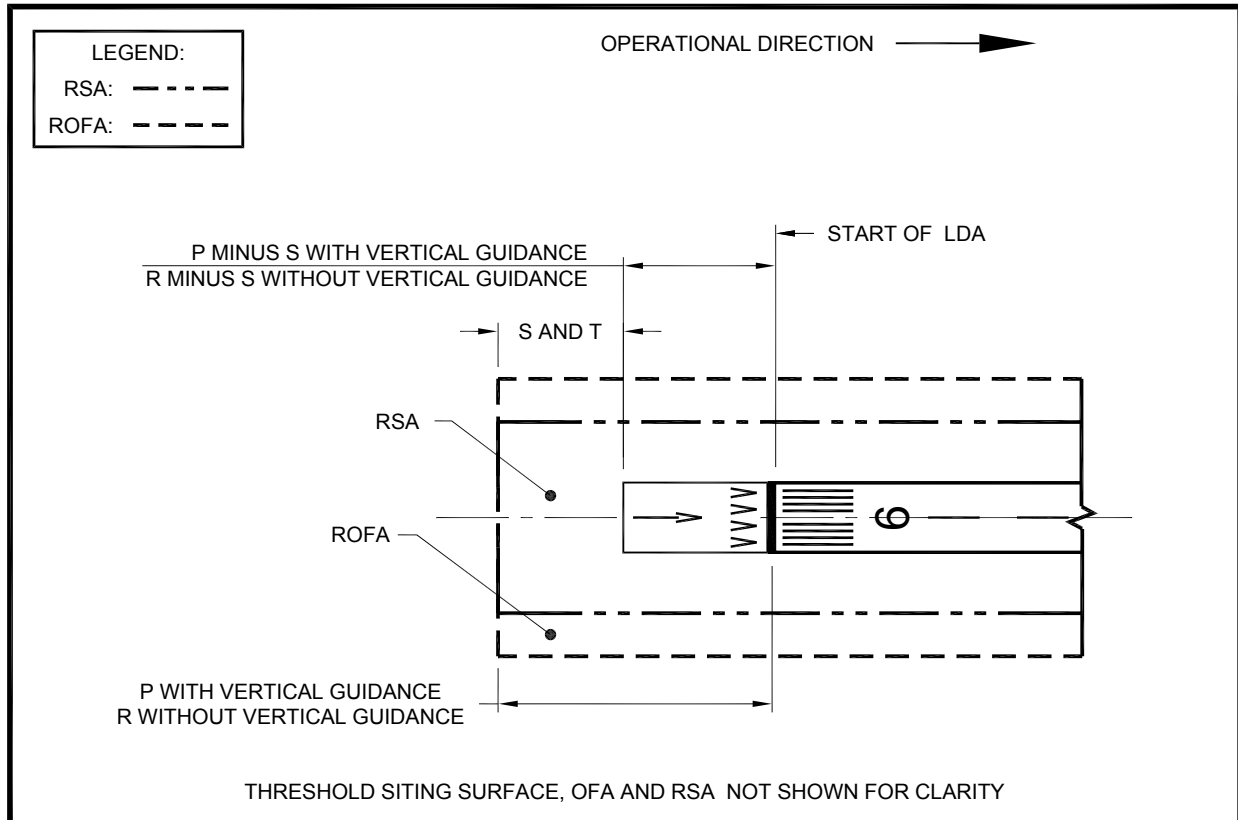


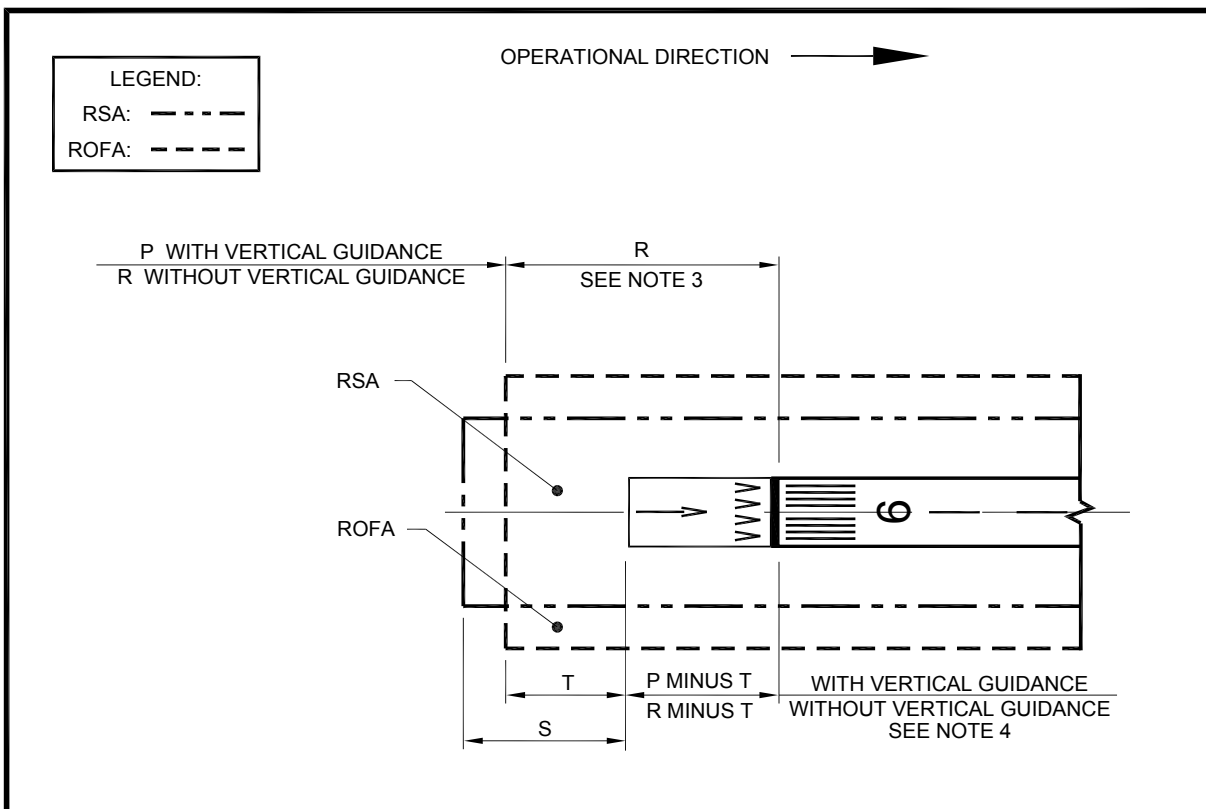
Figure 3-40. Start of LDA at displaced threshold based on approach RPZ located to mitigate unacceptable incompatible land use

**Notes:**

1. S denotes the existing or proposed length of the RSA beyond the runway end.
2. T denotes the existing or proposed length of the ROFA beyond the runway end.
3. When declared distances are used as an incremental improvement and the applicable P or R is not obtainable prior to the LDA, this dimension may equal the length of RSA obtainable prior to the LDA.
4. When declared distances are used as an incremental improvement and the applicable P or R is not obtainable prior to the LDA, this dimension may equal the length of RSA prior to the LDA minus S.

**Figure 3-41. Start of LDA at displaced threshold located to provide additional RSA**

**f. Notification.** The clearway and stopway lengths, if provided, and declared distances (TORA, TODA, ASDA, and LDA) will be provided by the airport owner for inclusion in the Airport Master Record (FAA Form 5010), A/FD (and in the Aeronautical Information Publication, for international airports) for each operational runway direction. Declared distances must be published for all international airports and Part 139 certificated airports, even when the distances are simply equal to the runway length in both directions. When the threshold is sited for small airplanes, report LDA as “LDA for airplanes of 12,500 lbs (5700 kg) or less maximum certificated takeoff weight.”

**Notes:**

1. S denotes the existing or proposed length of the RSA beyond the runway end.
2. T denotes the existing or proposed length of the ROFA beyond the runway end.
3. When declared distances are used as an incremental improvement and the applicable P or R is not obtainable prior to the LDA, this dimension may equal the length of ROFA obtainable prior to the LDA.
4. When declared distances are used as an incremental improvement and the applicable P or R is not obtainable prior to the LDA, this dimension may equal the length of ROFA prior to the LDA minus T.

**Figure 3-42. Start of LDA at displaced threshold located to provide additional ROFA**

**g. Documenting declared distances.** Record all standards that require a threshold displacement, and indicate the controlling threshold displacement; the reason for a takeoff starting farther up the runway based upon the takeoff direction (if applicable), and all reasons for limiting the TORA, TODA ASDA and LDA to less than the runway length (if applicable). Document the controlling limitations and the reason for the ASDA or TODA extending beyond the runway end. Where a limitation is removed, check to determine that there are no other limiting conditions before extending a respective distance. For obligated airports, provide the information to the responsible FAA Airports office and show the declared distances on the approved ALP.

### 323. Approach and Departure Reference Codes.

The runway to taxiway separation should be planned and designed per paragraph 320 for new infrastructure. However, for existing conditions the Approach and Departure Reference Codes (APRC and DPRC) describe the current operational capabilities of a runway and adjacent taxiways where no special operating procedures are necessary. In contrast, the RDC is based on

planned development and has no operational application. The APRC and DPRC may change over time as improvements are made to the runway, taxiways, and NAVAIDs.

**a. Approach Reference Code (APRC).** Like the RDC, the APRC is composed of three components: AAC, ADG, and visibility minimums. Visibility minimums are expressed as RVR values in feet of 1600, 2400, 4000, and 5000 (nominally corresponding to lower than 1/2 mile, lower than 3/4 mile but not lower than 1/2 mile, not lower than 3/4 mile, and not lower than one mile, respectively). The third component for a runway operated under visual approach conditions (including circling approaches) only should read “VIS.” Certain critical standards, as detailed in [Table 3-4](#), determine which aircraft can operate on taxiways adjacent to a runway under particular meteorological conditions with no special operational procedures necessary. A runway may have more than one APRC, such as D/V/1600 and D/VI/2400. [Table 3-7](#) summarizes the relationship between runway to taxiway separation and APRC.

**b. Departure Reference Code (DPRC).** The DPRC represents those aircraft that can take off from a runway while any aircraft are present on adjacent taxiways, under particular meteorological conditions with no special operational procedures necessary. It is similar to the APRC, but is composed of two components, AAC and ADG. A runway may have more than one DPRC, such as B-III and D-II. [Table 3-8](#) summarizes the minimum runway to taxiway separation for each DPRC.

**Table 3-7. Approach Reference Code (APRC)**

Visibility Minimums	Runway to Taxiway Separation (ft)									
	≥150	≥200	≥225	≥240	≥250	≥300	≥350	≥400	≥500	≥550
Visual	B/I(S)/VIS	B/I(S)/VIS	B/I/VIS	B/II/VIS	B/II/VIS	B/III/VIS D/II/VIS	B/III/VIS	D/IV/VIS D/V/VIS	D/VI/VIS	D/VI/VIS
Not lower than 1 mile	B/I(S)/5000	B/I(S)/5000	B/I/5000	B/II/5000	B/II/5000	B/III/5000 D/II/5000	B/III/5000	D/IV/5000 D/V/5000	D/VI/5000	D/VI/5000
Not lower than 3/4 mile	B/I(S)/4000	B/I(S)/4000	B/I/4000	B/II/4000	B/II/4000	B/III/4000 D/II/4000	B/III/4000	D/IV/4000 D/V/4000	D/VI/4000	D/VI/4000
Lower than 3/4 mile but not lower than 1/2 mile		B/I(S)/2400	B/I/4000 B/I(S)/2400	B/II/4000	B/I/2400	B/III/4000 <sup>1</sup> D/II/4000 B/II/2400	B/III/2400	D/IV/2400 D/V/2400	D/VI/2400	D/VI/2400
Lower than 1/2 mile								D/V/2400 D/IV/1600	D/VI/2400 D/V/1600	D/VI/1600

**Notes:** (S) denotes small aircraft

Entries for Approach Category D also apply to Approach Category E. However, there are no Approach Category E aircraft currently in the civil fleet.

For ADG-VI aircraft with tail heights of less than 66 feet (20 m), ADG-V separation standards may be used.

**1. How to use this table:**

Each APRC entry denotes a combination of Aircraft Approach Category, Airplane Design Group, and visibility condition under which landing operations may be conducted without operational mitigations. Within an APRC, operations may be conducted by airplanes up to the AAC and ADG, and down to the visibility conditions noted. In this example, with visibility minimums of lower than 3/4 mile but not lower than 1/2 mile, the applicable APRCs are B/III/4000, D/II/4000, and B/II/2400. This means that following aircraft may land:

- Within Approach Categories A & B, Airplane Design Groups I(S), I, II, & III, down to 3/4 mile visibility.
- Within Approach Categories C & D, Airplane Design Groups I & II, down to 3/4 mile visibility.
- Within Approach Categories A & B, Airplane Design Groups I(S), I & II, down to 1/2 mile visibility.

**Table 3-8. Departure Reference Code (DPRC)**

<b>Runway to Taxiway Separation (ft)</b>					
<b>≥ 150</b>	<b>≥ 225</b>	<b>≥ 240</b>	<b>≥ 300</b>	<b>≥ 400</b>	<b>≥ 500</b>
B/I(S)	B/I	B/II	B/III D/II	D/IV D/V <sup>1</sup>	D/VI <sup>2</sup>

**Notes:** (S) denotes small aircraft

Entries for Approach Category D also apply to Approach Category E. However, there are no Approach Category E aircraft currently in the civil fleet.

- Example: With a runway to taxiway separation of 300 feet, the following airplanes may depart:
  - Within Approach Categories A & B, Airplane Design Groups I(S), I, II, & III.
  - Within Approach Categories C & D, Airplane Design Groups I & II.
  - Thus, an airplane of Approach Category C, Airplane Design Group III requires a runway to taxiway separation of 400 feet for departure.
- For unrestricted operations by ADG-VI airplanes, a runway to taxiway separation of 500 feet is required. However, ADG-VI airplanes may depart with aircraft on the parallel taxiway where the runway to taxiway separation is as little as 400 feet as long as **no ADG-VI aircraft** occupy the parallel taxiway beyond 1500 feet of the point of the start of takeoff roll.  
When there is snow, ice or slush contamination on the runway, ADG-VI airplanes may depart with aircraft on the parallel taxiway where the runway to taxiway separation is as little as 400 feet as long as **no aircraft** occupy the parallel taxiway beyond 1500 feet of the point of the start of takeoff roll.

**324. to 399. Reserved.**

**Page intentionally left blank.**



## Chapter 4. Taxiway and Taxilane Design

### 401. General.

This chapter presents the design standards for taxiways and taxilanes. It provides guidance on recommended taxiway and taxilane layouts to enhance safety by avoiding runway incursions. Taxiway turns and intersections are designed to enable safe and efficient taxiing by airplanes while minimizing excess pavement. Existing taxiway geometry should be improved whenever feasible, with emphasis on “hot spots.” To the extent practicable, the removal of existing pavement may be necessary to correct confusing layouts.

**a. Taxiway Design Group (TDG).** Previous guidance on taxiway design was based only on Airplane Design Groups (ADG). ADGs are based on wingspan and tail height, but not the dimensions of the aircraft undercarriage. The design of pavement fillets must consider such undercarriage dimensions. Thus, the following guidance establishes TDGs, based on the overall Main Gear Width (MGW) and the Cockpit to Main Gear Distance (CMG). Some airplanes have special steering characteristics (e.g. steerable main gear). In such cases, use the “effective CMG” provided by the manufacturer. See [Figure 1-1](#).

#### **b. Design method.**

**(1) Taxi Method.** Taxiways are designed for “cockpit over centerline” taxiing with pavement being sufficiently wide to allow a certain amount of wander. The allowance for wander is provided by the Taxiway Edge Safety Margin (TESM), which is measured from the outside of the landing gear to the taxiway edge. Adequate pavement fillets should be provided on turns to ensure the prescribed TESH is maintained when the pilot guides the aircraft around turns while the cockpit follows the centerline. “Judgmental oversteering,” where the pilot must intentionally steer the cockpit outside the marked centerline, while allowing aircraft to operate on existing taxiways designed for smaller aircraft, should not be used as a design technique intended to reduce paving costs. When constructing new taxiways, upgrade other intersections along the associated route to eliminate judgmental oversteering whenever feasible. This will allow pilots to use a consistent taxi method throughout the airport.

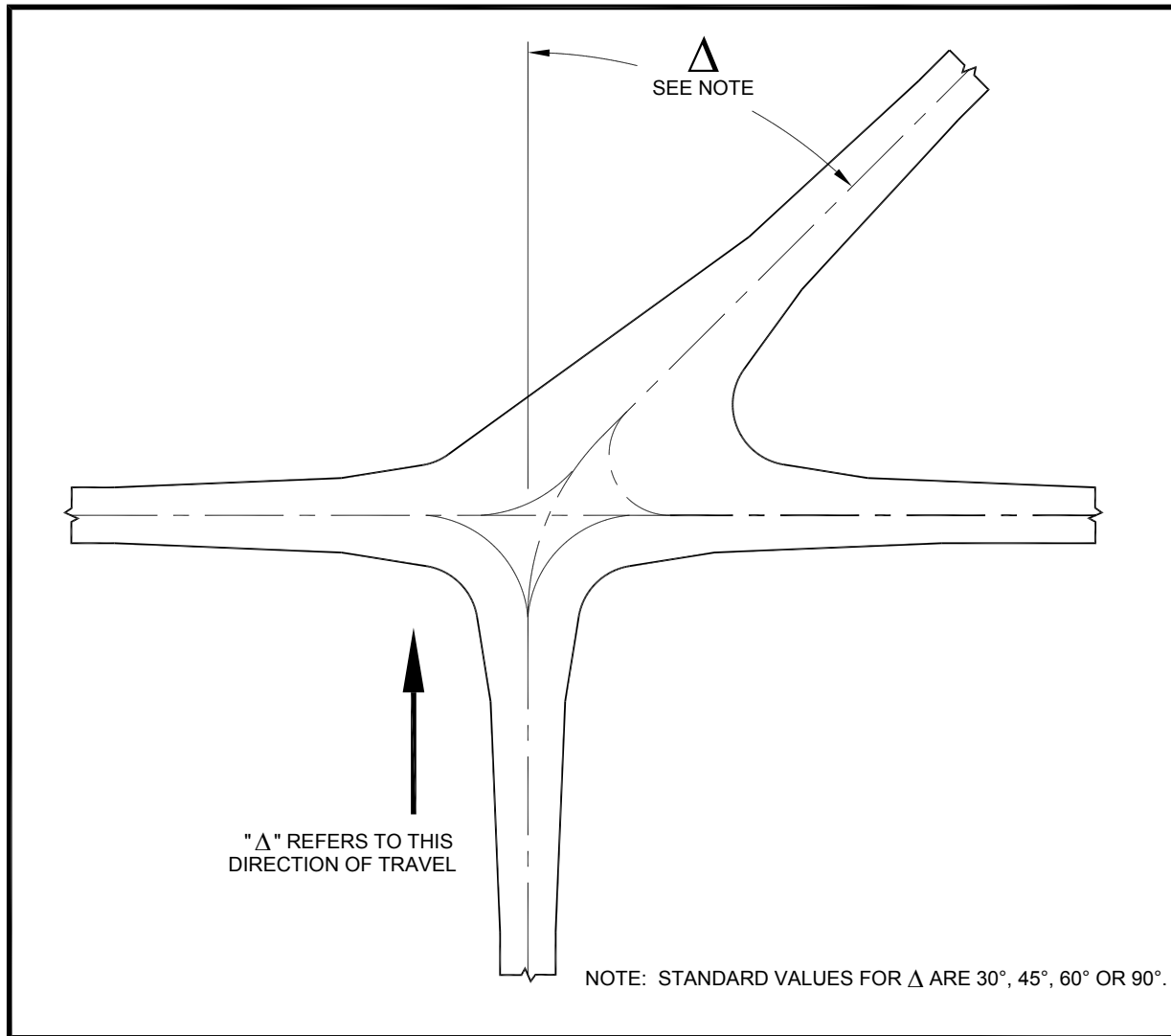
**(2) Steering Angle<sup>2</sup>.** Taxiways should be designed such that the nose gear steering angle is no more than 50 degrees, the generally accepted value to prevent excessive tire scrubbing. This will not always be possible, however, such as in the case of the construction of a crossover taxiway between existing parallel taxiways.

**(3) Three-Node Concept.** Good airport design practices keep taxiway intersections simple by reducing the number of taxiways intersecting at a single location and allows for proper placement of airfield markings, signage and lighting. Complex intersections

---

<sup>2</sup> Where dimensions in this AC are based on nose gear steering angle, all calculations of nose gear steering angle assume that the nose gear is directly under or forward of the cockpit. Where the nose gear is aft of the cockpit, the actual nose gear steering angle will be slightly less. This conservative design allows for the slight slippage experienced by the nose gear in cornering.

increase the possibility of pilot error. The “three-node concept” means that a pilot is presented with no more than three choices at an intersection – ideally, left, right and straight ahead. See [Figure 4-1](#).



**Figure 4-1. Three-node taxiway intersection**

(4) **Intersection Angles.** Design turns to be 90 degrees wherever possible. For intersections, standard angles (deltas) of 30, 45, 60, 90, 120, 135, and 150 degrees are preferred. Angles other than standard will require specific design based on the criteria in paragraphs [401.b](#). See paragraph [406.b](#) for guidance on fillet design. See [Figure 4-1](#).

(5) **Runway Incursions.** As noted in paragraph [203](#), the airport designer must keep basic concepts in mind to reduce the probability of runway incursions through proper airport geometry. This is particularly important when designing a taxiway system. Some of these basic concepts that apply to taxiway design are detailed below. Examples of confusing intersections to be avoided are shown in [Figure 4-4](#) and [Figure 4-5](#). Intersections prone to

wrong-runway takeoffs are not recommended for construction. These and other existing nonstandard conditions should be corrected as soon as practicable.

(a) Increase Pilot Situational Awareness. A pilot who knows where he/she is on the airport is less likely to enter a runway improperly. Complexity leads to confusion. Keep taxiway systems simple, using the “three-node” concept.

(b) Avoid wide expanses of pavement. Taxiway to runway interface encompassing wide expanses of pavement is not recommended. Wide pavements require placement of signs far from a pilot’s eye and reduce the conspicuity of other visual cues. Under low visibility conditions or due to pilot focus on the centerline, signs can be missed. This is especially critical at runway entrance points. Where a wide expanse of pavement is unavoidable, such as a crossover providing for a 180 degree turn between parallel taxiways, avoid direct access to a runway.

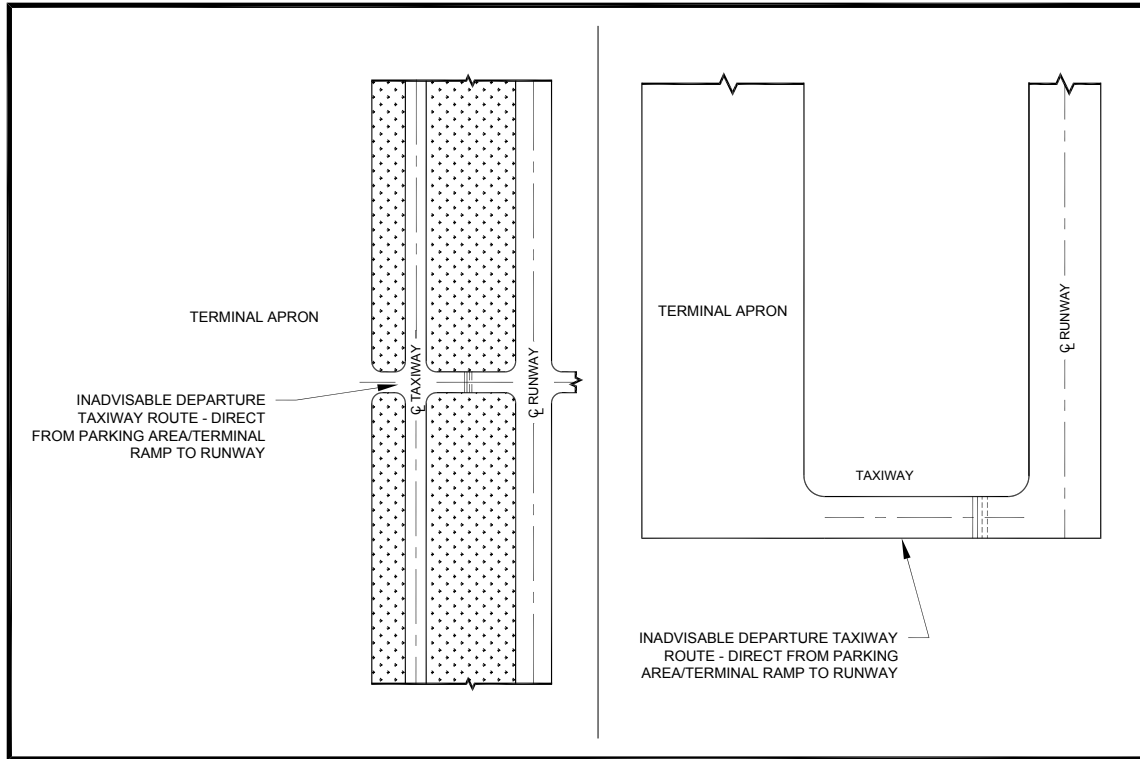
(c) Limit runway crossings. The airport designer can reduce the opportunity for human error by reducing the need for runway crossings. The benefits of such design are twofold – through a simple reduction in the number of occurrences, and through a reduction in air traffic controller workload.

(d) Avoid “high energy” intersections. These are intersections in the middle third of the runways. By limiting runway crossings to the outer thirds of the runway, the portion of the runway where a pilot can least maneuver to avoid a collision is kept clear.

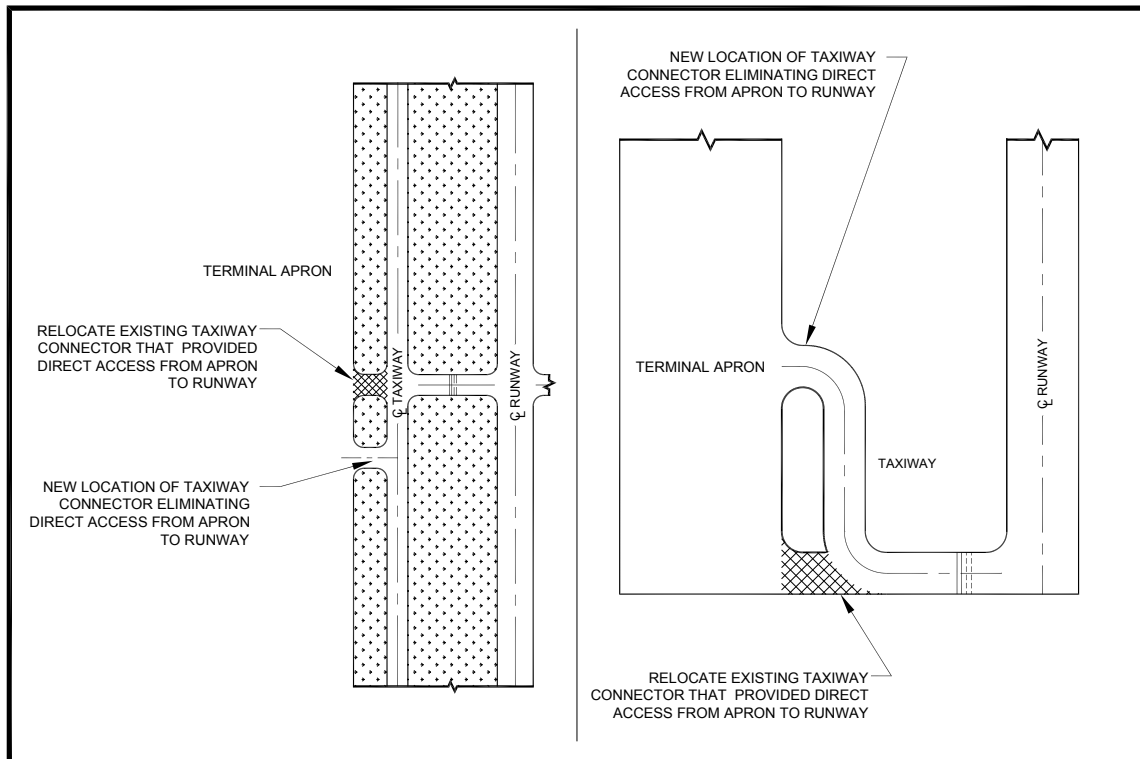
(e) Increase visibility. Right angle intersections, both between taxiways and between taxiways and runways, provide the best visibility to the left and right for a pilot. Acute angle runway exits provide for greater efficiency in runway usage, but should not be used as runway entrance or crossing points. A right angle turn at the end of a parallel taxiway is a clear indication of approaching a runway.

(f) Avoid “dual purpose” pavements. Runways used as taxiways and taxiways used as runways can lead to confusion. A runway should always be clearly identified as a runway and only a runway.

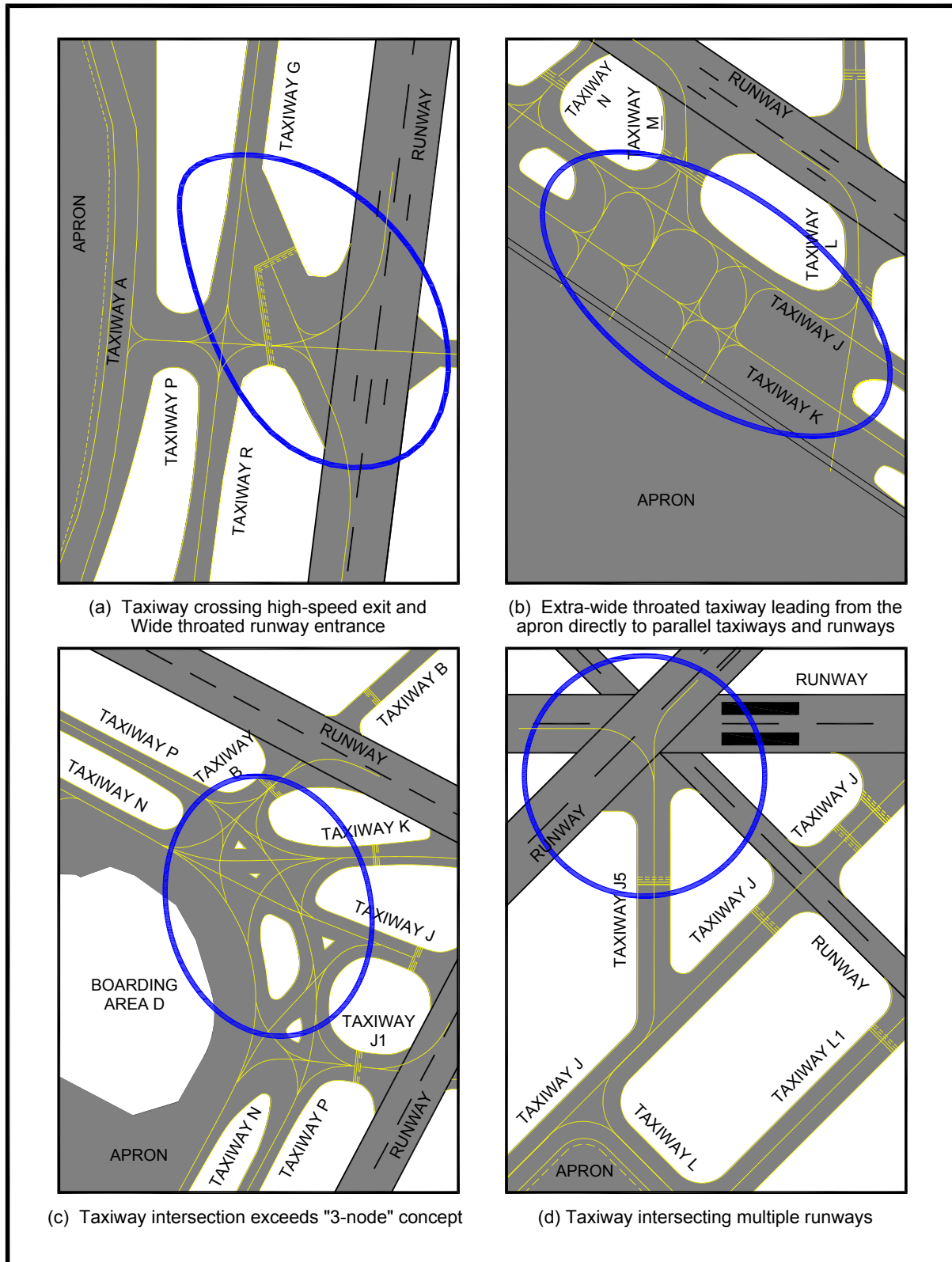
(g) Indirect Access. Do not design taxiways to lead directly from an apron to a runway without requiring a turn. Such configurations can lead to confusion when a pilot typically expects to encounter a parallel taxiway but instead accidentally enters a runway. See [Figure 4-2](#) and [Figure 4-3](#).



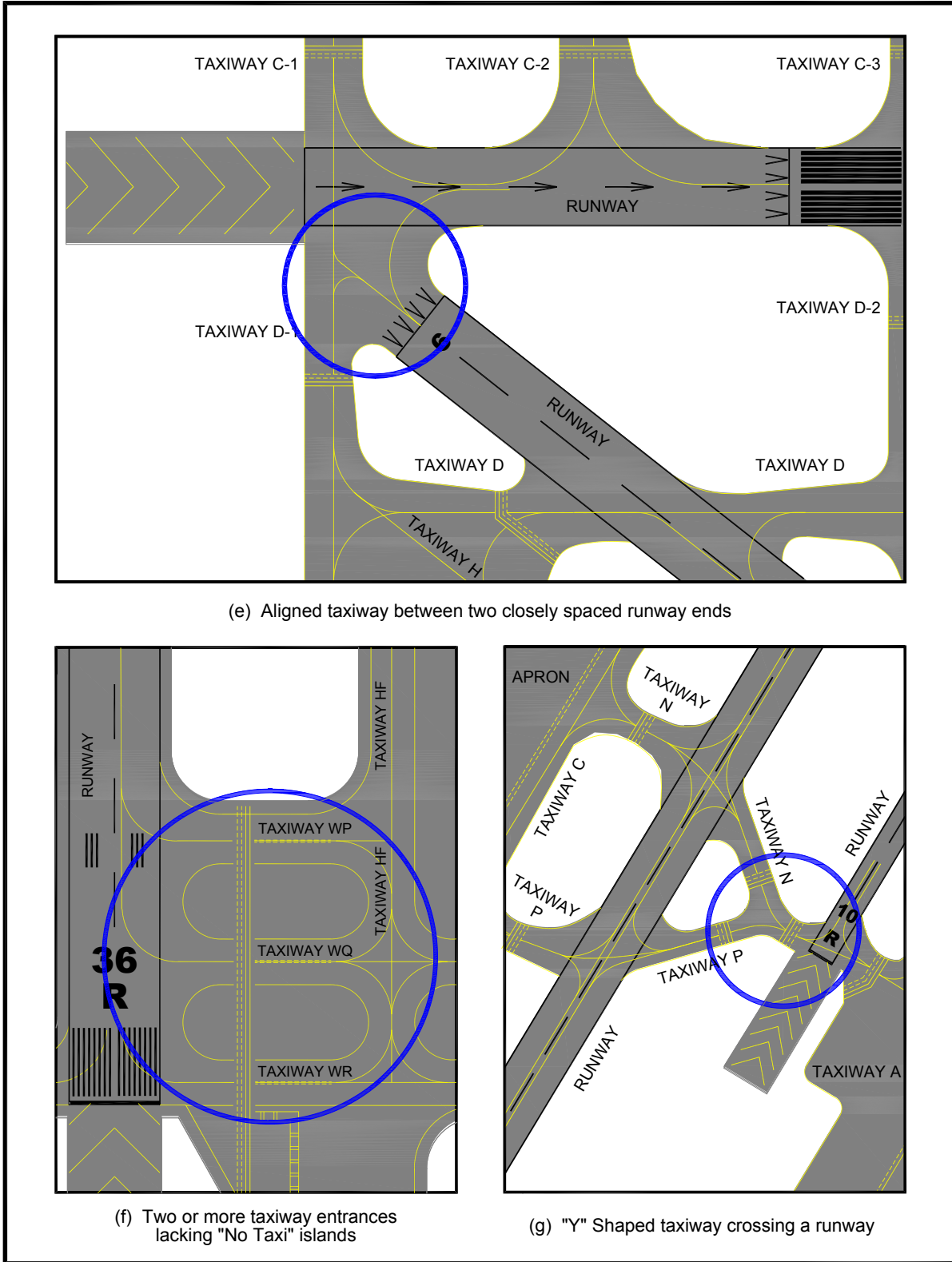
**Figure 4-2. Not recommended taxiway design**



**Figure 4-3. Proper taxiway design**



**Figure 4-4. Taxiway designs that are not recommended (examples a, b, c, d)**



**Figure 4-5. Taxiway designs that are not recommended (examples e, f, g)**

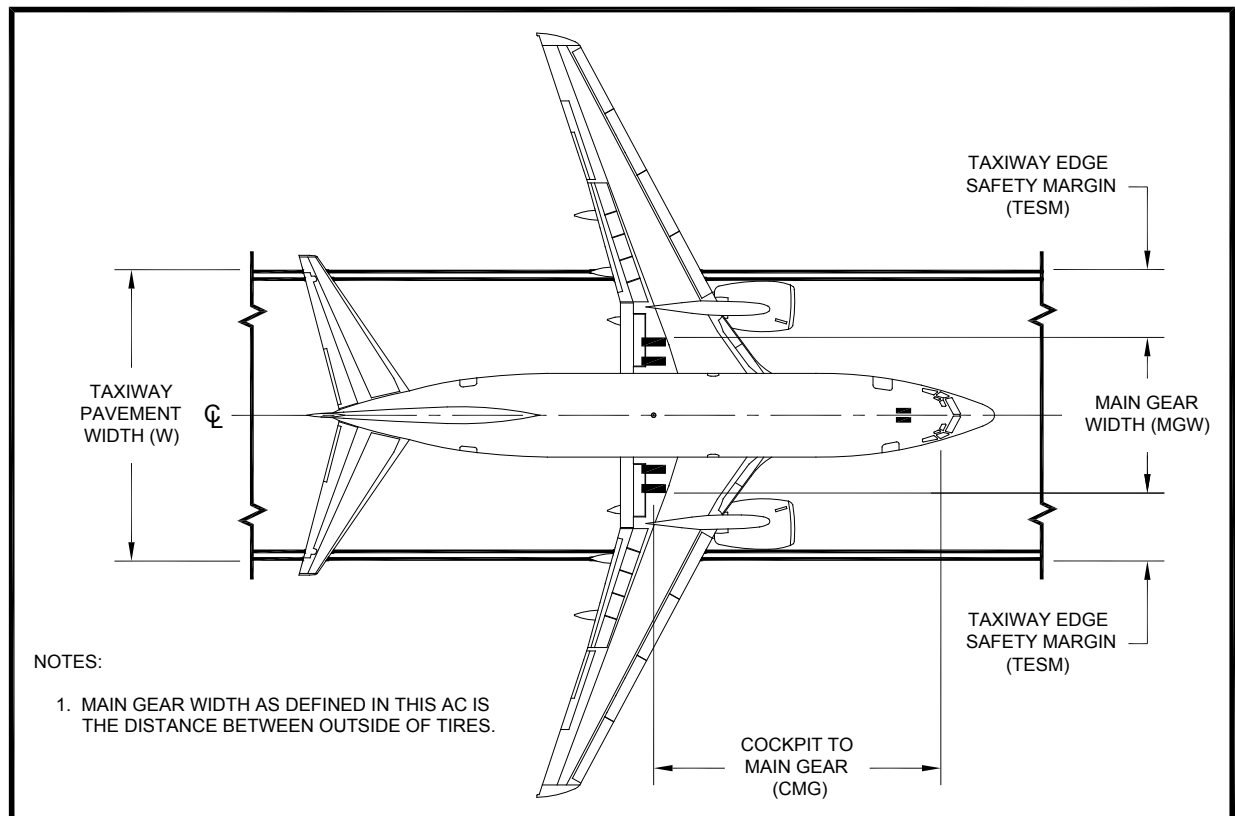
(h) Hot Spots. Redesign of hot spots identified in the FAA Airport Diagrams that may increase the risk of runway incursions is a priority when the associated runway or taxiway is subject to reconstruction or rehabilitation. Other non-standard taxiway design elements should be corrected as soon as practicable.

(6) Coordination. An efficient taxiway system can only be designed with knowledge of operational requirements. Coordination with the airport's Airport Traffic Control Tower (ATCT) personnel is essential, especially at busier airports with parallel runways and multiple aprons, and where departure queues are common and inbound and outbound traffic could conflict.

(7) Operational Requirement. Changes in taxiway geometry in response to Air Traffic operational needs must be analyzed for possible effects on runway incursions. Coordinate with the Safety Risk Management (SRM) team when analyzing proposed taxiway geometry. See Order 5200.11 for projects within the movement area.

#### 402. Taxiway definitions.

See paragraph 102 for detailed definitions.



**Notes:**

1. For dimension TESH and dimension W values, see Table 4-2.
2. See Appendix 1 for CMG and MGW data.

**Figure 4-6. Taxiway Edge Safety Margin (TESM) on straight segment**

**403. Taxiway/taxilane width.**

Pavement width requirements for taxiing airplanes are based on TDG, which in turn is based on the dimensions of the airplane's undercarriage, that is, the MGW and the CMG. The minimum width for straight segments and the geometry of pavement fillets on turns ensure that the required TESM is maintained for all maneuvers. Fillet dimensions for each TDG are summarized in [Table 4-3](#), [Table 4-4](#), [Table 4-5](#), [Table 4-6](#), [Table 4-7](#), [Table 4-8](#), [Table 4-9](#) and [Table 4-10](#), which represent TDG 1A, 1B, etc., respectively, for standard taxiway intersection angles. Use standard taxiway intersection angles when possible. Non-standard intersection angles will require modeling airplane movement. See paragraph [406.b\(2\)](#).

**404. Taxiway/taxilane clearance requirements.**

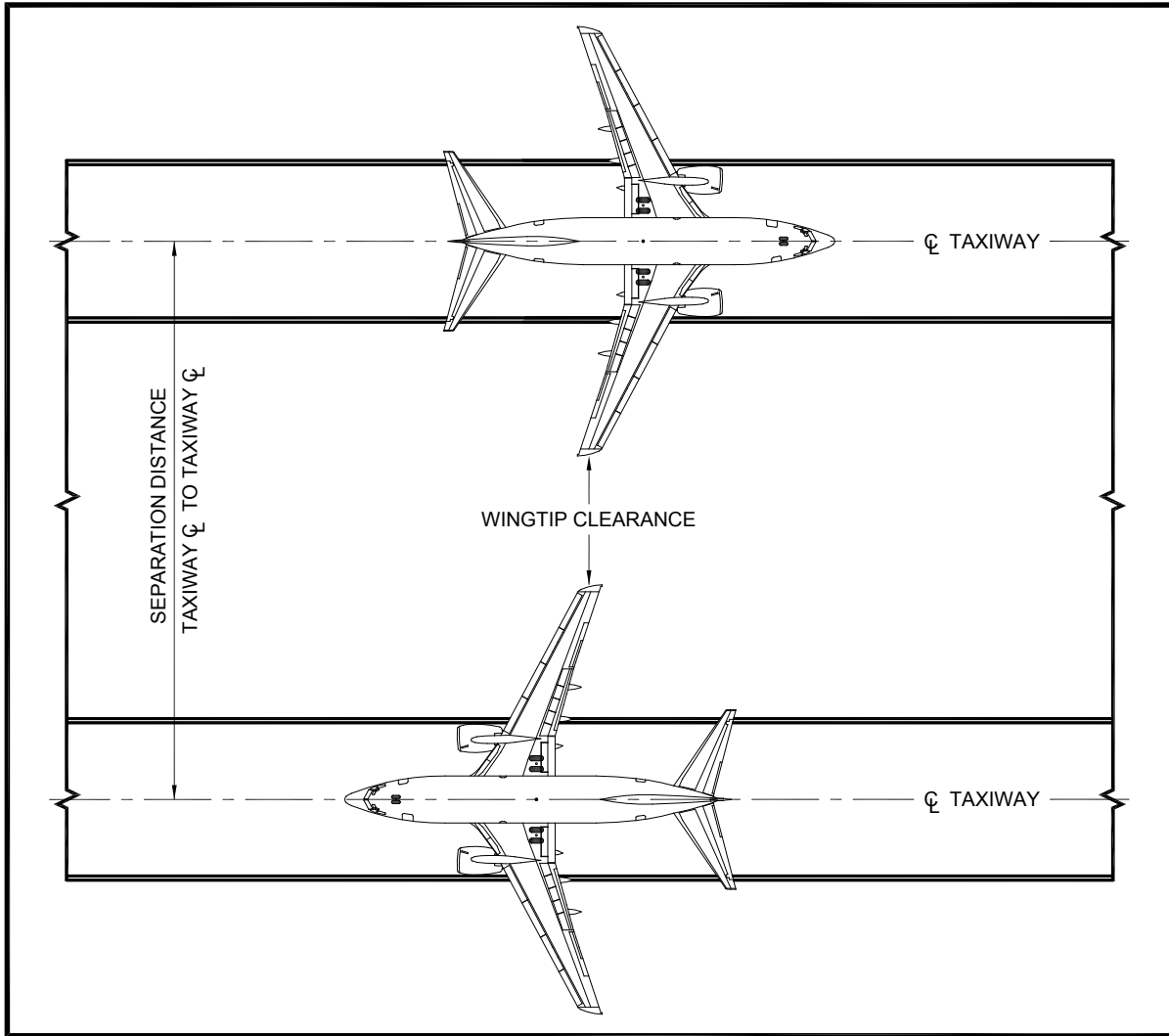
**a. Taxiway separations.** The required distance between a taxiway/taxilane centerline and other objects is based on the required wingtip clearance, which is a function of the wingspan, and is thus determined by ADG. The need for ample wingtip clearance is driven by the fact that the pilots of most modern jets cannot see their aircraft's wingtips. The required distance between a taxiway/taxilane centerline and another taxiway/taxilane centerline, however, may be a function of the TDG because of turning requirements.

(1) Taxiway to taxiway centerline separation, as shown in [Figure 4-7](#) and [Table 4-1](#), is equal to 1.2 times the maximum wingspan of the ADG plus 10 feet (3 m). This gives a wingtip clearance of 0.2 times the wingspan plus 10 feet (3 m). For taxiways built to different ADGs, use the wingtip clearance required by the higher ADG. However, this separation may need to be increased based on TDG, as shown in [Figure 4-23](#) and [Table 4-2](#). The minimum radius to prevent excessive tire scrubbing is one which results in a maximum nosewheel steering angle (B) of 50 degrees. Refer to [Engineering Brief No. 78](#), Linear Equations for Evaluating the Separation of Airplane Design Groups on Parallel Taxiways and Taxiways to Fixed/Movable Objects, for existing taxiways where it is not practicable to meet the standard for the full ADG.

(2) Taxiway centerline to object separation, as shown in [Figure 4-8](#) and [Table 4-1](#), is equal to 0.7 times the maximum wingspan of ADG, plus 10 feet (3 m), resulting in the same wingtip clearance as noted above. Applying this separation to both sides of the taxiway centerline defines the Taxiway/Taxilane Object Free Area (OFA) (see paragraph [404.b](#)). Refer to [Engineering Brief No. 78](#) for existing taxiways and objects where it is not practicable to meet the standard for the full ADG.

(3) Parallel taxilane to taxilane centerline separation is equal to 1.1 times the maximum wingspan of ADG plus 10 feet (3 m), as shown in [Figure 4-9](#). This gives a wingtip clearance of 0.1 times the wingspan plus 10 feet (3 m). Reduced clearances are acceptable because taxi speed is very slow outside the movement area, taxiing is precise and special operator guidance techniques and devices are normally present. Refer to [Engineering Brief No. 78](#) for existing taxilanes where it is not practicable to meet the standard for the full ADG.





**Figure 4-7. Wingtip clearance - parallel taxiways**

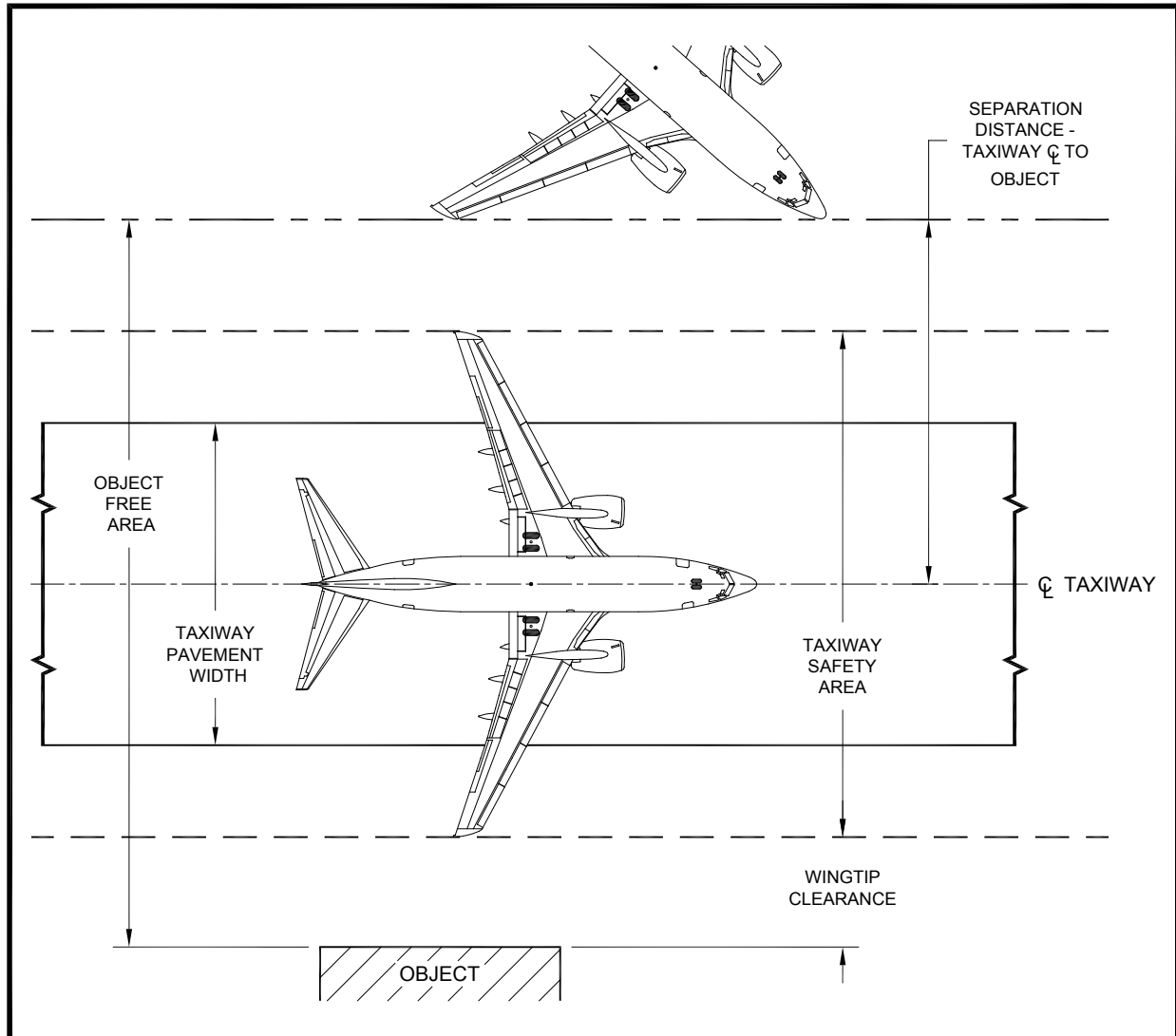
**Table 4-1. Design standards based on Airplane Design Group (ADG)**

ITEM	DIM (See Figure 3-26)	ADG					
		I	II	III	IV	V	VI
<b>TAXIWAY PROTECTION</b>							
TSA	E	49 ft (15 m)	79 ft (24 m)	118 ft (36 m)	171 ft (52 m)	214 ft (65 m)	262 ft (80 m)
Taxiway OFA		89 ft (27 m)	131 ft (40 m)	186 ft (57 m)	259 ft (79 m)	320 ft (98 m)	386 ft (118 m)
Taxilane OFA		79 ft (24 m)	115 ft (35 m)	162 ft (49 m)	225 ft (69 m)	276 ft (84 m)	334 ft (102 m)
<b>TAXIWAY SEPARATION</b>							
<i>Taxiway Centerline to Parallel Taxiway/Taxilane Centerline</i> <sup>1</sup>	J	70 ft (21 m)	105 ft (32 m)	152 ft (46.5 m)	215 ft (65.5 m)	267 ft (81 m)	324 ft (99 m)
<i>Taxiway Centerline to Fixed or Movable Object</i>	K	44.5 ft (13.5 m)	65.5 ft (20 m)	93 ft (28.5 m)	129.5 ft (39.5 m)	160 ft (48.5 m)	193 ft (59 m)
<i>Taxilane Centerline to Parallel Taxilane Centerline</i> <sup>1</sup>		64 ft (19.5 m)	97 ft (29.5 m)	140 ft (42.5 m)	198 ft (60 m)	245 ft (74.5 m)	298 ft (91 m)
<i>Taxilane Centerline to Fixed or Movable Object</i>		39.5 ft (12 m)	57.5 ft (17.5 m)	81 ft (24.5 m)	112.5 ft (34 m)	138 ft (42 m)	167 ft (51 m)
<b>WINGTIP CLEARANCE</b>							
Taxiway Wingtip Clearance		20 ft (6 m)	26 ft (8 m)	34 ft (10.5 m)	44 ft (13.5 m)	53 ft (16 m)	62 ft (19 m)
Taxilane Wingtip Clearance		15 ft (4.5 m)	18 ft (5.5 m)	27 ft (6.5 m)	27 ft (8 m)	31 ft (9.5 m)	36 ft (11 m)

**Note: 1.** These values are based on wingtip clearances. If direction reversal between parallel taxiways is needed, use this dimension or the dimension specified in [Table 4-14](#) or [Table 4-15](#), whichever is largest.

**Table 4-2. Design standards based on Taxiway Design Group (TDG)**

ITEM	DIM (See Figure 4-6)	TDG							
		1A	1B	2	3	4	5	6	7
Taxiway Width	W	25 ft (7.5 m)	25 ft (7.5 m)	35 ft (10.5 m)	50 ft (15 m)	50 ft (15 m)	75 ft (23 m)	75 ft (23 m)	82 ft (25 m)
Taxiway Edge Safety Margin	TESM	5 ft (1.5 m)	5 ft (1.5 m)	7.5 ft (2 m)	10 ft (3 m)	10 ft (3 m)	15 ft (4.6m)	15 ft (4.6m)	15 ft (4.6m)
Taxiway Shoulder Width		10 ft (3 m)	10 ft (3 m)	15 ft (3 m)	20 ft (6 m)	20 ft (6 m)	30 ft (9 m)	30 ft (9 m)	40 ft (12 m)
Taxiway/Taxilane Centerline to Parallel Taxiway/Taxilane Centerline w/ 180 Degree Turn	J	See <a href="#">Table 4-14</a>							
<b>TAXIWAY FILLET DIMENSIONS</b>		<a href="#">Table 4-3</a>	<a href="#">Table 4-4</a>	<a href="#">Table 4-5</a>	<a href="#">Table 4-6</a>	<a href="#">Table 4-7</a>	<a href="#">Table 4-8</a>	<a href="#">Table 4-9</a>	<a href="#">Table 4-10</a>



**Figure 4-8. Wingtip clearance from taxiway**

(4) Taxilane centerline to object separation, as shown in [Figure 4-9](#), is equal to 0.6 times the maximum wingspan of ADG plus 10 feet (3 m), resulting in the same wingtip clearance noted above. Applying this separation to both sides of the taxilane centerline defines the Taxilane OFA (see [paragraph 404.b](#)). Refer to [Engineering Brief No. 78](#) for existing taxilanes and objects where it is not practicable to meet the standard for the full ADG.

(5) Parallel taxiways/taxilanes for dissimilar ADGs. For parallel taxiways/taxilanes serving dissimilar ADGs, the width of the OFA is determined by determining the OFA dimensions for each taxiway/taxilane separately, with the wingtip clearance between them based on the larger ADG or higher use (taxiway versus taxilane).

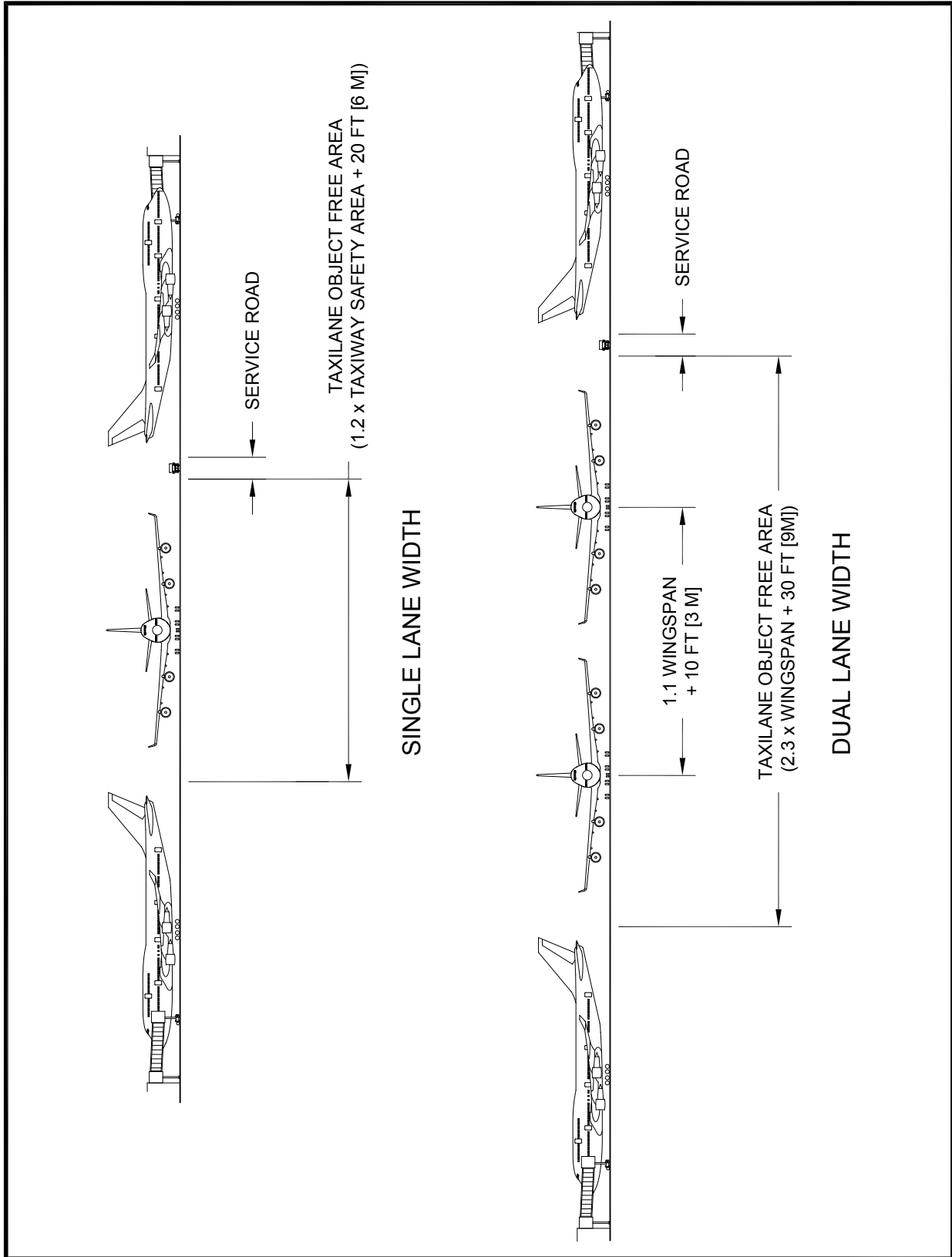
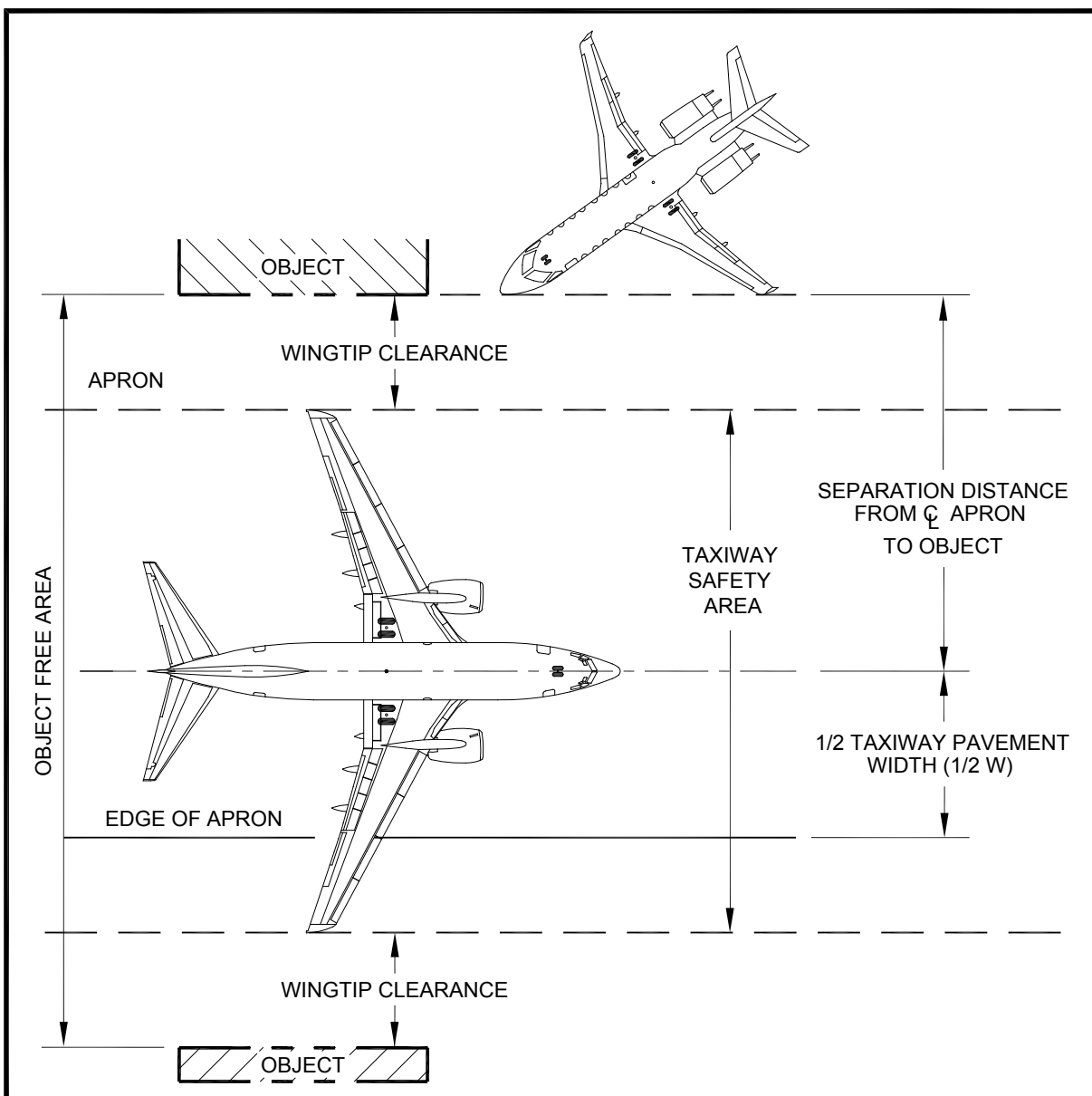


Figure 4-9. Wingtip clearance from taxiway

**b. Taxiway and Taxilane Object Free Area (TOFA).** The taxiway and taxilane OFAs are centered on the taxiway and taxilane centerlines as shown in [Figure 4-8](#), [Figure 4-9](#), and [Figure 4-10](#).

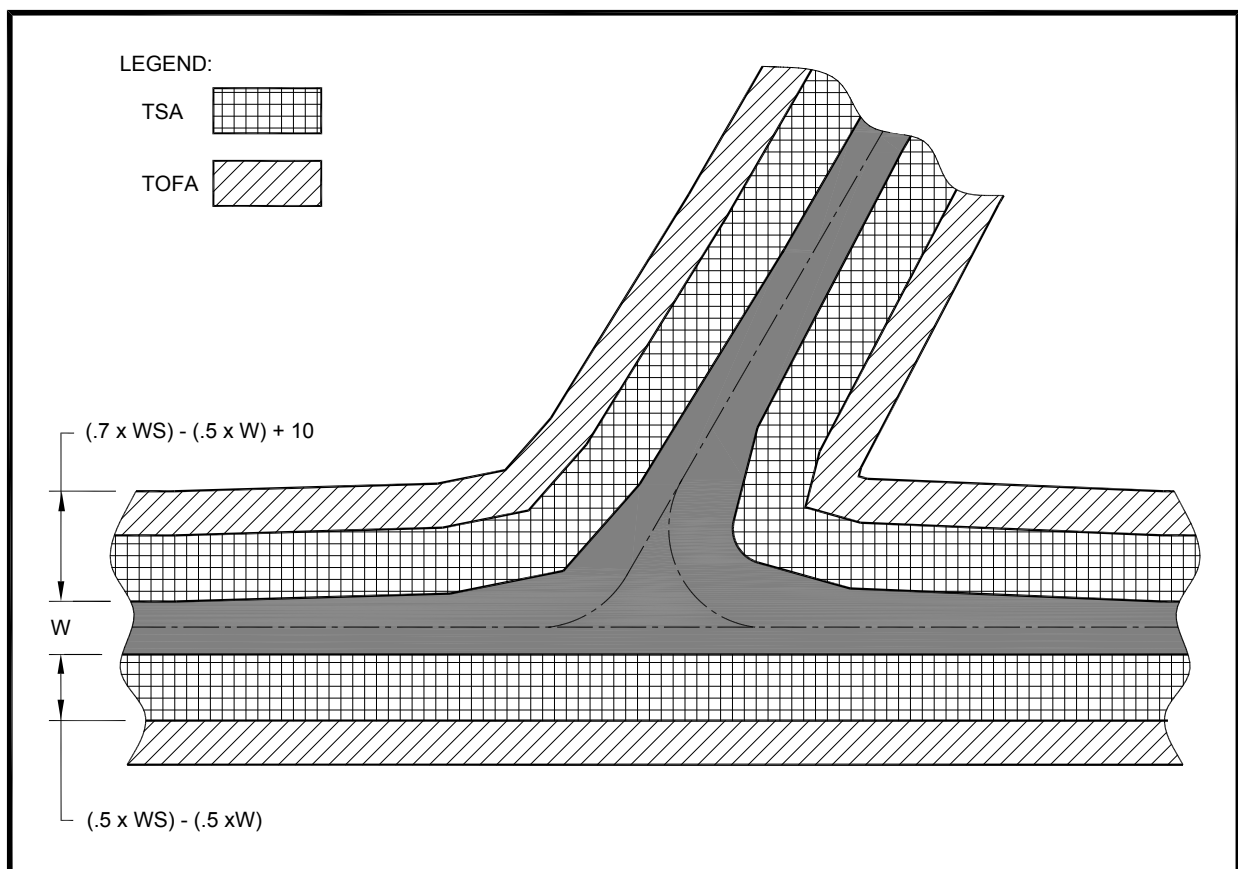


**Figure 4-10. Wingtip clearance from apron taxiway**

(1) The taxiway and taxilane OFA clearing standards prohibit service vehicle roads, parked aircraft, and other objects, except for objects that need to be located in the OFA for air navigation or aircraft ground maneuvering purposes. Vehicles may operate within the OFA provided they give right of way to oncoming aircraft by either maintaining a safe distance ahead or behind the aircraft or by exiting the OFA to let the aircraft pass. Provide vehicular exiting areas along the outside of the OFA where required. [Table 4-1](#) specifies the standard dimensions for OFAs.

(2) The width of the OFA must be increased at intersections and turns. OFA standards must be met for a distance of  $[(0.7 \times WS) - (0.5 \times W) + 10]$  feet from the taxiway/taxilane edge, based on standard fillet design, where WS is the maximum wingspan of the ADG and W is the taxiway width. (See [Figure 4-11.](#))

c. **Taxiway/Taxilane Safety Area (TSA).** The TSA is centered on the taxiway/taxilane centerline. To provide room for rescue and fire-fighting operations, the TSA width equals the maximum wingspan of the ADG. [Table 4-1](#) presents TSA dimensional standards. The width of the TSA must be increased at intersections and turns where curved taxiway or taxilane centerline pavement markings, reflectors, or lighting are provided. TSA standards must be met for a distance of  $[(0.5 \times WS) - (0.5 \times W)]$  feet from the taxiway/taxilane edge, based on standard fillet design, where WS is the maximum wingspan of the ADG and W is the taxiway width. (See [Figure 4-11.](#))



**Figure 4-11. TSA and TOFA at taxiway intersections**

- d. **Design standards.** The TSA must be:
- (1) cleared and graded and have no potentially hazardous ruts, humps, depressions, or other surface variations;
  - (2) drained by grading or storm sewers to prevent water accumulation;

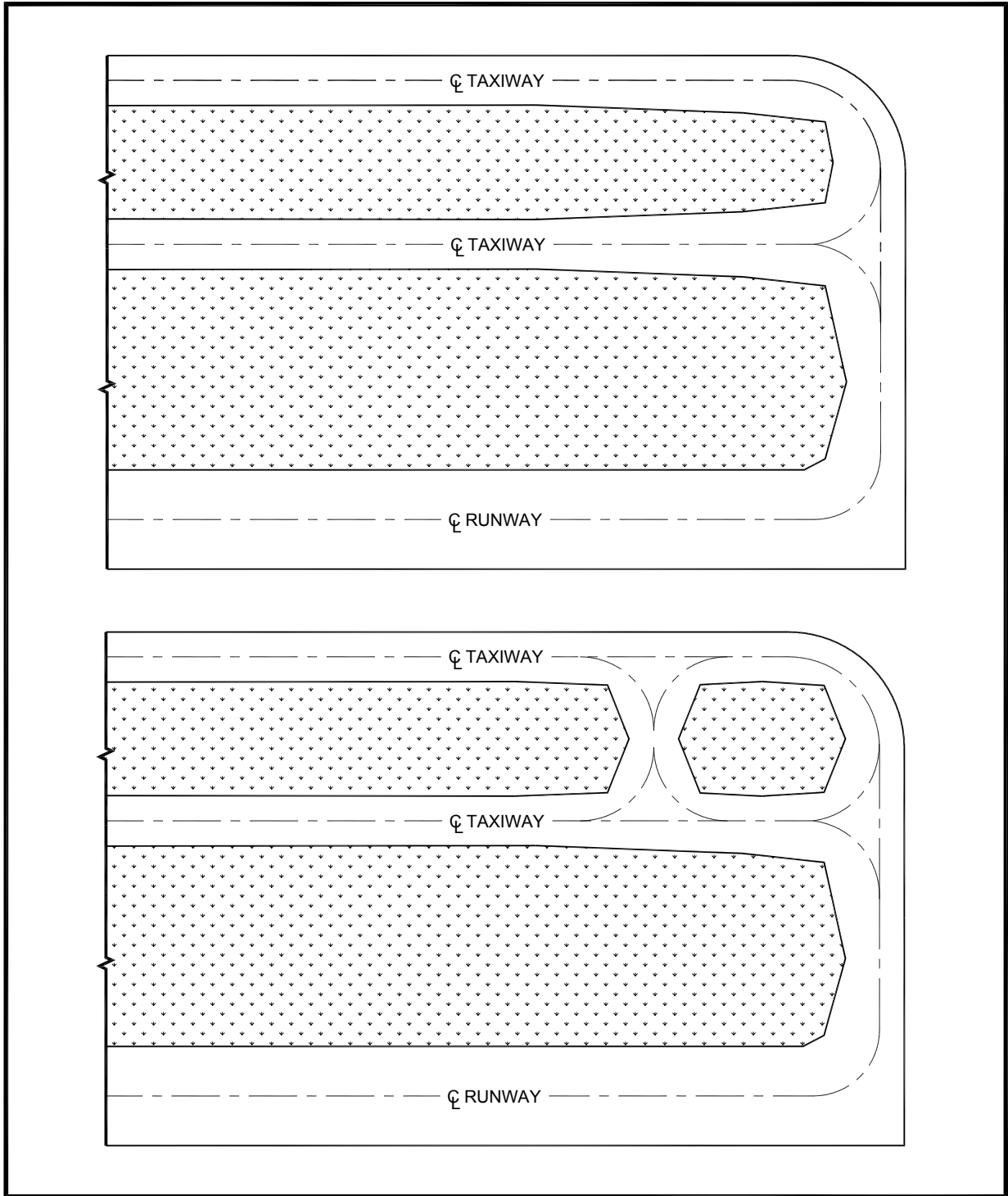
(3) capable, under dry conditions, of supporting snow removal equipment, Aircraft Rescue and Fire Fighting (ARFF) equipment, and the occasional passage of aircraft without causing structural damage to the aircraft; and

(4) free of objects, except for objects that need to be located in the TSA because of their function. Objects higher than 3 inches (76 mm) above grade must be constructed on Low Impact Resistant (LIR) supports (frangible mounted structures) of the lowest practical height with the frangible point no higher than 3 inches (76 mm) above the grade adjacent to any foundation. Other objects, such as manholes, should be constructed at grade. In no case may their height exceed 3 inches (76 mm) above grade.

e. **Construction standards.** Specifications for compaction of TSAs are provided in AC 150/5370-10, Item P-152, Excavation, Subgrade and Embankment.

#### **405. Parallel taxiways.**

A parallel taxiway eliminates using the runway for taxiing, thus increasing capacity and protecting the runway under low visibility conditions. In addition, a full length parallel taxiway is required for instrument approach procedures with visibility minimums below one mile and recommended for all other conditions. To accommodate high density traffic, airport planners should consider multiple access points to runways through the use of multiple parallel taxiways. For example, to facilitate Air Traffic Control (ATC) handling when using directional flow releases, e.g., south departure, west departure, etc., aircraft may be selectively queued on dual (or even triple) parallel taxiways. A dual parallel taxiway provides the ability for airplanes to taxi behind an airplane holding at a runway holdline. A dual parallel taxiway Figure 4-12 need not extend the full length of runway. The need for a parallel taxiway may be fulfilled by a series of taxiways generally parallel to the runway, allowing taxiing between each end of the runway without crossing the runway that they are generally parallel to, and providing an unobstructed view of the runway. See paragraphs 409.c and 409.d, interactive Table 3-5, and Table 3-6 regarding runway to taxiway separation requirements.



**Figure 4-12. Parallel taxiways**



**a. Taxiway to taxiway separation.** The required separation distance between parallel taxiways is generally determined by the ADG, as summarized in Table 4-1. However, the required separation may be determined by TDG because of the required turn radius, as shown in Table 4-2.

**b. Runway to Taxiway Separation.** See paragraph 409.c for additional information on the effect of exit taxiway design on runway/taxiway separation.

#### **406. Curves and intersections.**

**a. Cockpit over centerline.** Curves and intersections should be designed for cockpit over centerline steering. Taxiway intersections designed for cockpit over centerline steering enable rapid movement of traffic with minimal risk of aircraft excursions from the pavement surface. See Figure 4-13, Figure 4-14, Figure 4-15; and Table 4-3 and the subsequent seven tables representing TDG 1A, 1B, etc., respectively. The bottom half of Figure 4-13 shows the methodology for the design of taxiway fillets, and Appendix 8 provides a detailed explanation. The fillet geometry is determined by the longest CMG, widest MGW theoretical airplane in the TDG, along with the TESM for the TDG. The radius of the outer edge of the pavement is determined by the shortest CMG, widest MGW theoretical airplane in the TDG and each TDG below, along with the TESM associated with each TDG. See Table 4-11 and Figure 4-16. The nose gear is never the critical gear, as the outer taxiway edge is always defined by an aircraft with equal MGW but shorter CMG.

#### **b. Fillet design.**

**(1) General.** Pavement fillets at taxiway intersections are designed for the entire selected TDG and must accommodate all aircraft of all lesser TDGs. Figure 4-13, Figure 4-14, Figure 4-15, and Figure 4-24 illustrate the dimensions necessary to provide the minimum pavement necessary for taxiway fillets. Table 4-3 and the subsequent seven tables provide values for the variables in Figure 4-13, Figure 4-14, and Figure 4-15, for taxiway intersections with standard angles of 30, 45, 60, 90, 120, 135, and 150 degrees. The designs also apply to taxiway-apron intersections. Plan taxiway intersections to require a turn of no more than 90 degrees whenever possible. Obtuse angle turns require a much larger fillet to accommodate the main gear. The design should consider constructability and maintenance, and it will often be preferable to construct more pavement than the minimum required to maintain the TESM. The use of Computer Aided Design (CAD) software for this purpose is acceptable. However, excess fillet pavement and islands between areas where pavement is not required should be marked as unusable, and lighting and signs should be installed where they would be installed if the excess pavement did not exist. This allows installation of lighting and signs that would otherwise be far from a pilot's eye.

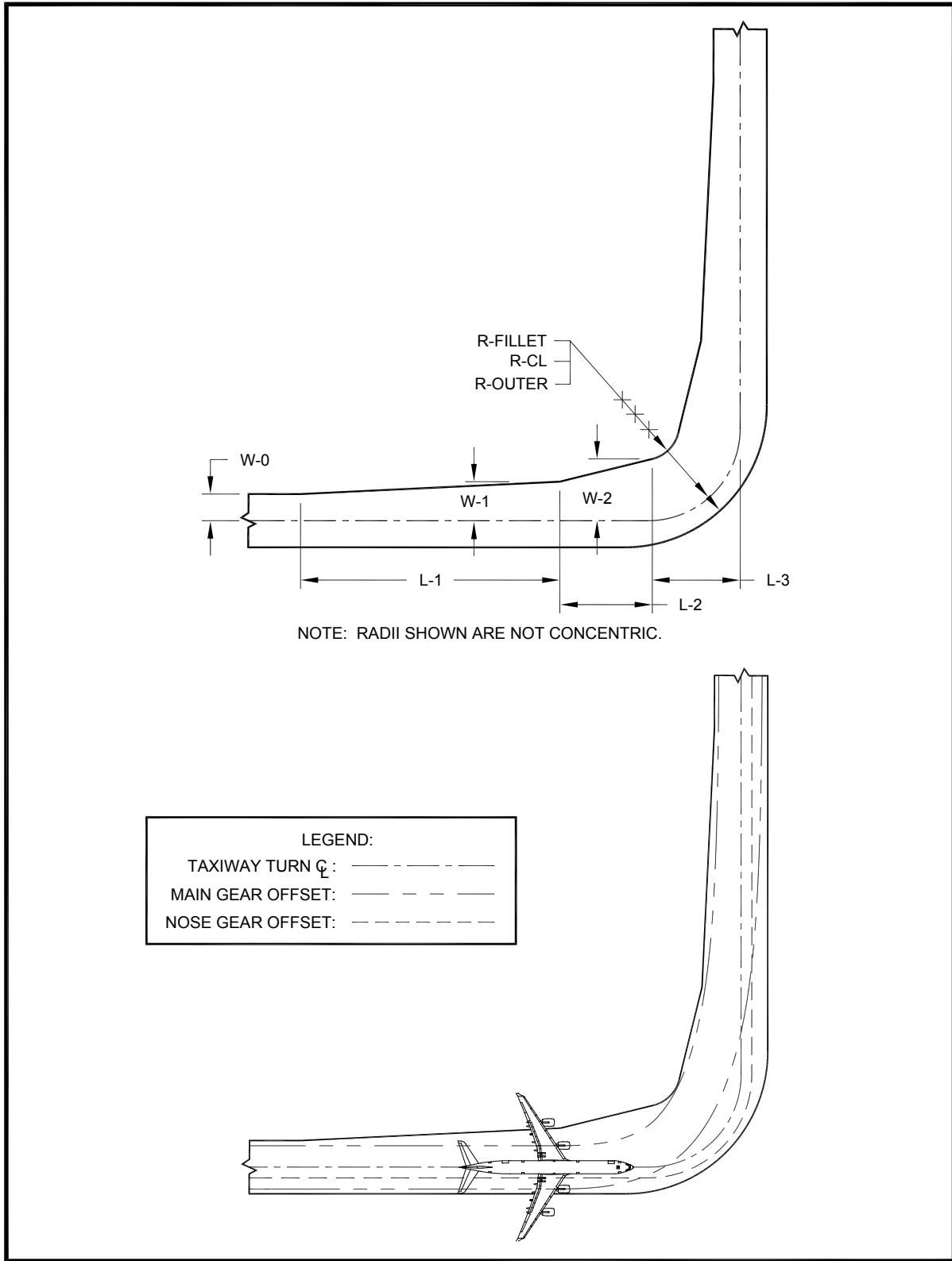
**(2) Modeling airplane movements.** It will not always be feasible to construct taxiway intersections using standard angles and associated fillets. In such cases, airplane movements must be modeled using CAD software. When modeling airplane ground maneuvering, design for the entire TDG, checking all critical combinations of CMG, MGW and TESM for the TDG indicated in Table 4-11. Ensure that the TESM is maintained. To allow for the asymptotic nature of an airplane realigning with the taxiway centerline when exiting a turn,

the TESM may be reduced by 6 inches (15 cm) only for the purposes of calculating the length of the required lead-in taper. Guidance on the design of pavement fillets is provided in Appendix 8. Design tools that may help in designing taxiway intersections are available on the FAA web site at: [http://www.faa.gov/airports/engineering/airport\\_design/](http://www.faa.gov/airports/engineering/airport_design/).

(a) Existing construction. When upgrading an existing intersection to accommodate cockpit over centerline taxiing, it may be more efficient to construct larger fillets rather than relocate existing centerline lighting. See also paragraph 411.

(b) Closely spaced turns. The standard fillet designs shown are based on an airplane being aligned with the taxiway centerline at the start of a turn. When turns are close enough together such that the lead-in (see dimension L-1 in Figure 4-13, Figure 4-14, Figure 4-15, and Figure 4-24) from one turn overlaps the lead-in to another turn, this is an indication that the airplane would not be aligned with the taxiway centerline at the start of the subsequent turn. Such conditions often occur at right-angle runway exits/entrances where the runway to taxiway separation is based on ADG but the taxiways are designed based on TDG. See paragraph 408.a(2).

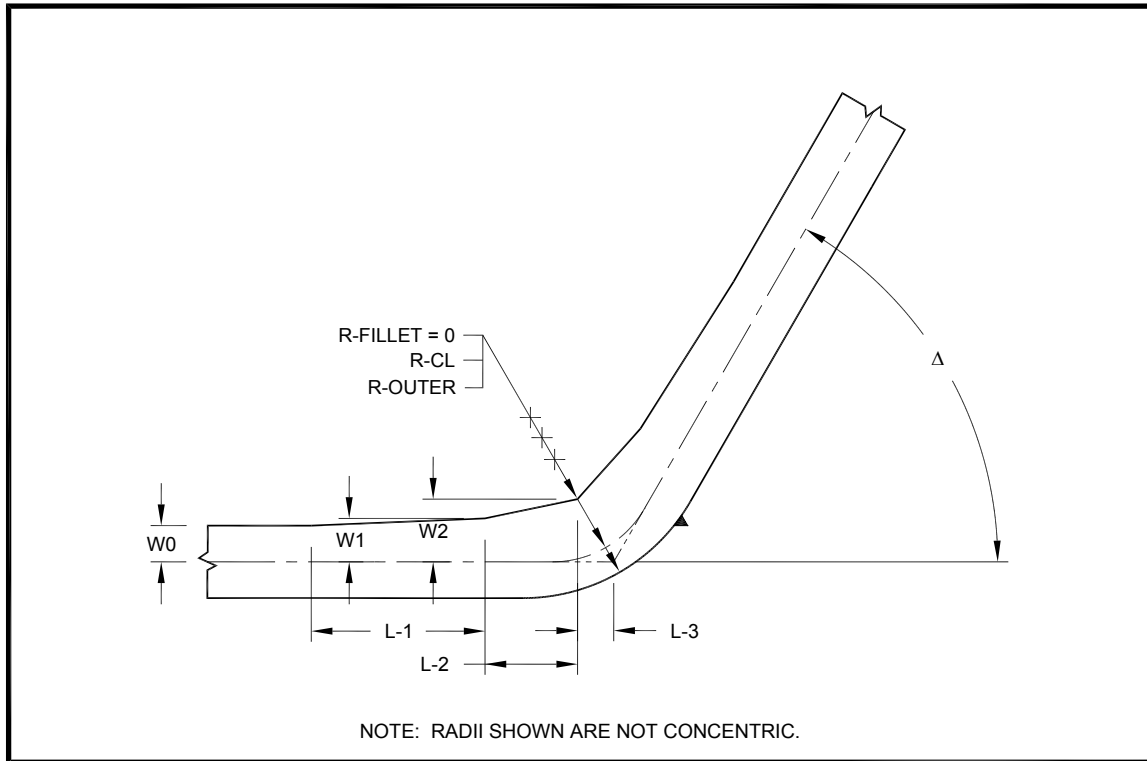
**c. Three-Node Concept.** All new taxiway intersections and existing intersections designated as “hot spots” on the FAA Airport Diagrams are to be constructed in accordance with the three-node design principle. Adherence to this principle keeps taxiway intersections simple by reducing the number of taxiways intersecting at a single location and allows for proper placement of airfield markings, signage and lighting. Complex intersections increase the possibility of pilot error. To the extent practicable, all existing taxiway intersections (not designated as hot spots) should also be reconfigured in accordance with the three-node design principle during the next capital project opportunity at that location. See Figure 4-1.



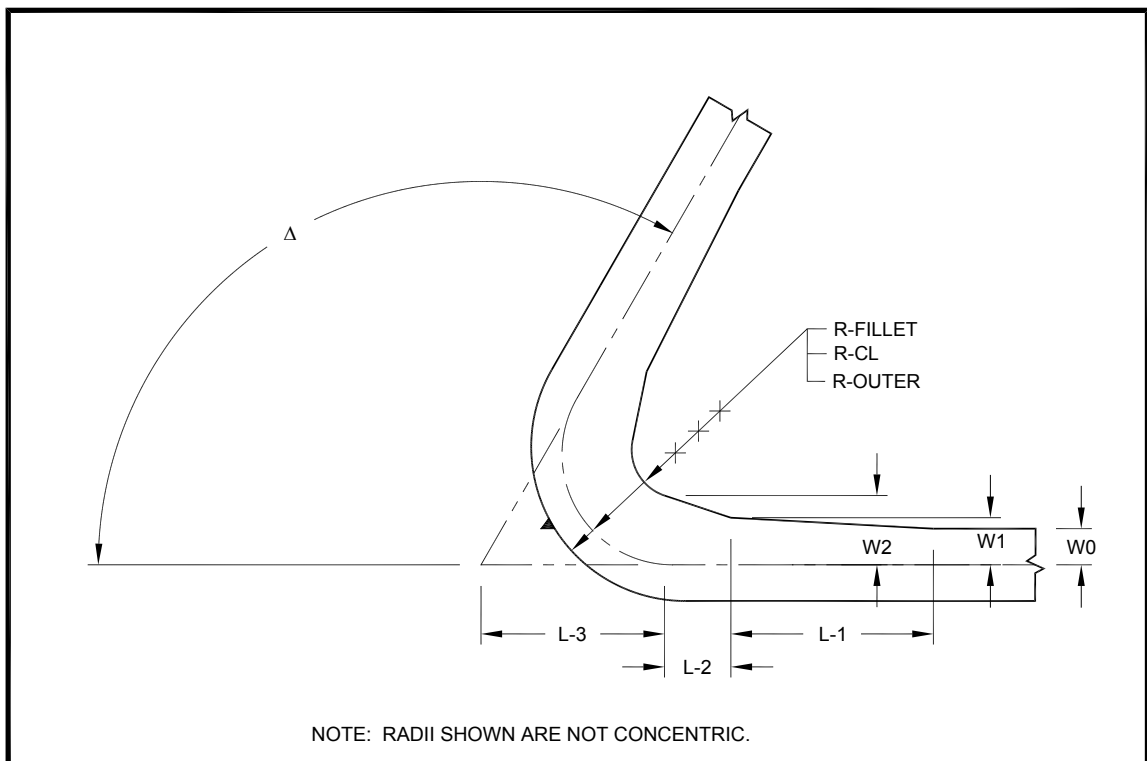
NOTE: RADII SHOWN ARE NOT CONCENTRIC.

**Note:** Offsets are shown in one direction, but offsets, and therefore fillets, are symmetrical.

**Figure 4-13. Taxiway turn - 90 degree delta**



**Figure 4-14. Taxiway turn - less than 90 degree delta**



**Figure 4-15. Taxiway turn - greater than 90 degree delta**

**Table 4-3. Standard intersection details for TDG 1A**

<b>TDG 1A</b>							
Dimension (See <a href="#">Figure 4-13</a> , <a href="#">Figure 4-14</a> , and <a href="#">Figure 4-15</a> )							
$\Delta$ (degrees)	30	45	60	90	120	135	150
W-0 (ft)	12.5	12.5	12.5	12.5	12.5	12.5	12.5
W-1 (ft)	16	18	20	21	22	23	24
W-2 (ft)	16	18	20	21	22	23	24
L-1 (ft)	39	46	52	53	55	56	56
L-2 (ft)	0	0	0	0	0	0	0
L-3 (ft)	4	8	12	21	39	56	89
R-Fillet (ft)	0	0	0	0	0	0	0
R-CL (ft)	50	50	50	25	25	25	25
R-Outer (ft)	62	62	62	37	37	37	37

**Note:** Values in the table are rounded to the nearest foot. 1 foot = 0.305 meters.

**Table 4-4. Standard intersection details for TDG 1B**

<b>TDG 1B</b>							
Dimension (See <a href="#">Figure 4-13</a> , <a href="#">Figure 4-14</a> , and <a href="#">Figure 4-15</a> )							
$\Delta$ (degrees)	30	45	60	90	120	135	150
W-0 (ft)	12.5	12.5	12.5	12.5	12.5	12.5	12.5
W-1 (ft)	20	23	26	17	18	18	18
W-2 (ft)	20	23	26	32	30	30	31
L-1 (ft)	106	120	130	90	96	97	97
L-2 (ft)	0	0	0	50	40	40	40
L-3 (ft)	5	10	15	32	79	114	180
R-Fillet (ft)	0	0	0	0	20	20	20
R-CL (ft)	50	50	50	40	50	50	50
R-Outer (ft)	62	62	62	52	62	62	62

**Note:** Values in the table are rounded to the nearest foot. 1 foot = 0.305 meters.

**Table 4-5. Standard intersection details for TDG 2**

<b>TDG 2</b>							
Dimension (See <u>Figure 4-13</u> , <u>Figure 4-14</u> , and <u>Figure 4-15</u> )							
$\Delta$ (degrees)	30	45	60	90	120	135	150
W-0 (ft)	17.5	17.5	17.5	17.5	17.5	17.5	17.5
W-1 (ft)	29	35	26	26	27	26	28
W-2 (ft)	29	35	40	48	48	50	54
L-1 (ft)	192	228	183	185	192	183	194
L-2 (ft)	0	0	60	75	65	75	71
L-3 (ft)	8	14	23	48	117	170	279
R-Fillet (ft)	0	0	0	0	25	25	25
R-CL (ft)	75	75	75	60	75	75	80
R-Outer (ft)	92	92	92	77	92	92	97

**Note:** Values in the table are rounded to the nearest foot. 1 foot = 0.305 meters.

**Table 4-6. Standard intersection details for TDG 3**

<b>TDG 3</b>							
Dimension (See <u>Figure 4-13</u> , <u>Figure 4-14</u> , and <u>Figure 4-15</u> )							
$\Delta$ (degrees)	30	45	60	90	120	135	150
W-0 (ft)	25	25	25	25	25	25	25
W-1 (ft)	30	32	32	33	34	33	35
W-2 (ft)	37	42	47	54	52	55	56
L-1 (ft)	152	170	174	175	185	179	191
L-2 (ft)	50	55	65	80	65	75	65
L-3 (ft)	10	17	27	54	125	183	288
R-Fillet (ft)	0	0	0	0	25	25	25
R-CL (ft)	75	75	75	60	75	80	80
R-Outer (ft)	100	100	100	85	100	105	105

**Note:** Values in the table are rounded to the nearest foot. 1 foot = 0.305 meters.

**Table 4-7. Standard intersection details for TDG 4**

TDG 4							
Dimension (See <u>Figure 4-13</u> , <u>Figure 4-14</u> , and <u>Figure 4-15</u> )							
Δ (degrees)	30	45	60	90	120	135	150
W-0 (ft)	25	25	25	25	25	25	25
W-1 (ft)	32	33	35	35	37	36	37
W-2 (ft)	43	52	60	72	68	70	72
L-1 (ft)	258	286	297	300	316	303	316
L-2 (ft)	100	112	120	145	115	133	121
L-3 (ft)	12	21	35	72	188	274	433
R-Fillet (ft)	0	0	0	0	50	50	50
R-CL (ft)	110	110	110	95	115	120	120
R-Outer (ft)	135	135	135	120	140	145	145

**Note:** Values in the table are rounded to the nearest foot. 1 foot = 0.305 meters.

**Table 4-8. Standard intersection details for TDG 5**

TDG 5							
Dimension (See <u>Figure 4-13</u> , <u>Figure 4-14</u> , and <u>Figure 4-15</u> )							
Δ (degrees)	30	45	60	90	120	135	150
W-0 (ft)	37.5	37.5	37.5	37.5	37.5	37.5	37.5
W-1 (ft)	44	47	48	49	50	50	50
W-2 (ft)	55	63	71	82	75	76	76
L-1 (ft)	254	287	300	310	317	321	320
L-2 (ft)	100	100	110	125	100	100	100
L-3 (ft)	15	26	41	82	201	289	451
R-Fillet (ft)	0	0	0	0	50	50	50
R-CL (ft)	110	110	110	95	115	120	120
R-Outer (ft)	350	285	195	162	160	165	160

**Note:** Values in the table are rounded to the nearest foot. 1 foot = 0.305 meters.

**Table 4-9. Standard intersection details for TDG 6**

TDG 6							
Dimension (See <a href="#">Figure 4-13</a> , <a href="#">Figure 4-14</a> , and <a href="#">Figure 4-15</a> )							
$\Delta$ (degrees)	30	45	60	90	120	135	150
W-0 (ft)	37.5	37.5	37.5	37.5	37.5	37.5	37.5
W-1 (ft)	44	46	49	55	56	56	55
W-2 (ft)	60	71	81	95	92	98	100
L-1 (ft)	313	347	387	433	440	436	430
L-2 (ft)	160	170	160	145	130	140	150
L-3 (ft)	16	29	47	95	230	338	537
R-Fillet (ft)	0	0	0	0	50	50	50
R-CL (ft)	150	150	150	115	140	150	150
R-Outer (ft)	350	285	250	180	185	194	192

**Note:** Values in the table are rounded to the nearest foot. 1 foot = 0.305 meters.

**Table 4-10. Standard intersection details for TDG 7**

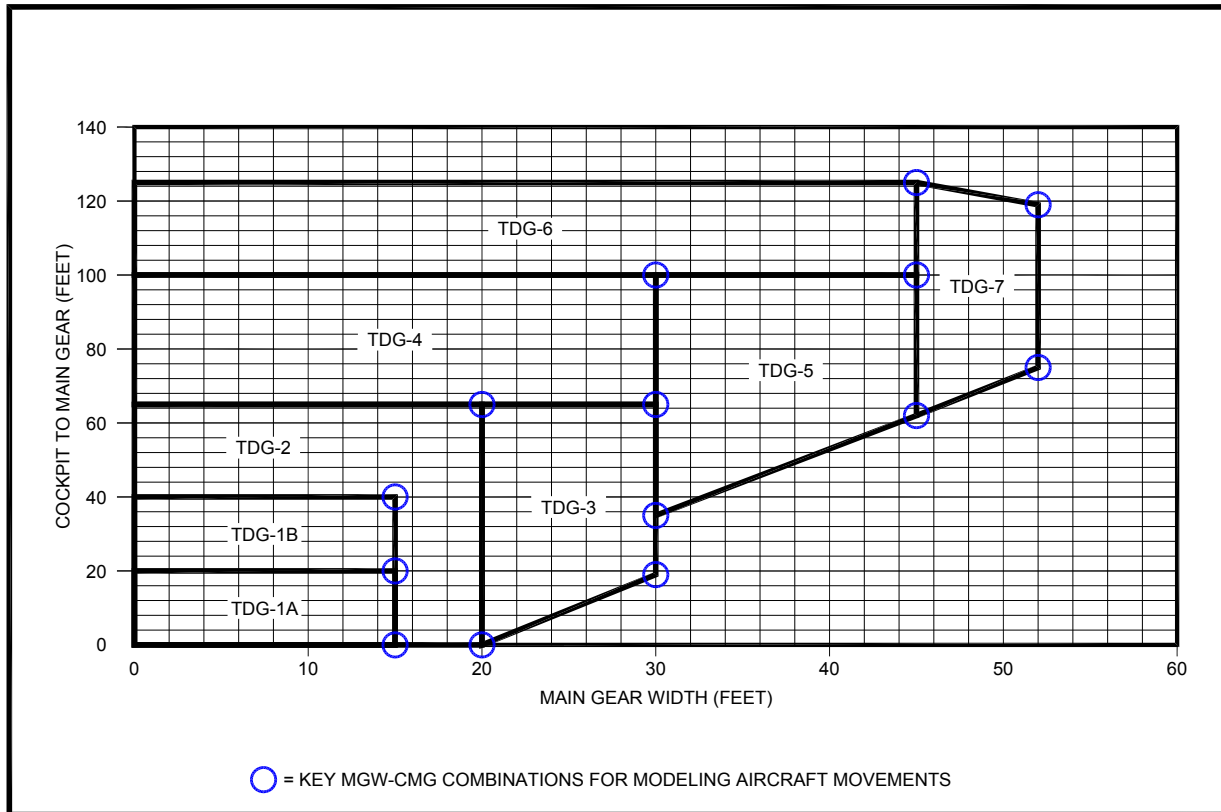
TDG 7							
Dimension (See <a href="#">Figure 4-13</a> , <a href="#">Figure 4-14</a> , and <a href="#">Figure 4-15</a> )							
$\Delta$ (degrees)	30	45	60	90	120	135	150
W-0 (ft)	41	41	41	41	41	41	41
W-1 (ft)	46	48	51	55	56	56	55
W-2 (ft)	63	73	82	95	92	98	100
L-1 (ft)	283	314	352	395	400	400	390
L-2 (ft)	160	170	160	145	130	140	150
L-3 (ft)	17	30	47	95	230	338	537
R-Fillet (ft)	0	0	0	0	50	50	50
R-CL (ft)	150	150	150	115	140	150	150
R-Outer (ft)	400	335	275	190	195	200	196

**Note:** Values in the table are rounded to the nearest foot. 1 foot = 0.305 meters.



**Table 4-11. MGW-CMG combinations**

TDG	TESM	MGW-CMG Combination				
1A	5	15-20	15-0			
1B	5	15-40	15-0			
2	7.5	20-65	20-0			
3	10	30-65	30-19			
4	10	30-100	30-19			
5	15	45-100	45-62	30-34		
6	15	45-125	45-62	30-34		
7	15	45-125	52-119	52-75	45-62	30-34



**Figure 4-16. Key MGW-CMG combinations for modeling aircraft movements**

**407. Runway/taxiway intersections.**

**a. Right angle.** Right-angle intersections are the standard for all runway/taxiway intersections, except where there is a need for high-speed exit taxiways and for taxiways parallel to crossing runways. Right-angle taxiways provide the best visual perspective to a pilot approaching an intersection with the runway to observe aircraft in both the left and right directions. They also provide the optimum orientation of the runway holding position signs so they are visible to pilots. FAA studies indicate the risk of a runway incursion increases exponentially on angled (less than or greater than 90 degrees) taxiways used for crossing the runway.

**b. Acute angle.** Acute angles should not be larger than 45 degrees from the runway centerline. A 30-degree taxiway layout should be reserved for high speed exit taxiways. The use of multiple intersecting taxiways with acute angles creates pilot confusion and improper positioning of taxiway signage.

**c.** Taxiways must never coincide with the intersection of two runways. Taxiway configurations with multiple taxiway and runway intersections in a single area create large expanses of pavement making it difficult to provide proper signage, marking and lighting. These expansive pavement areas and numerous markings for taxiway (yellow) and runway (white) centerline and edge markings lead to pilot disorientation.

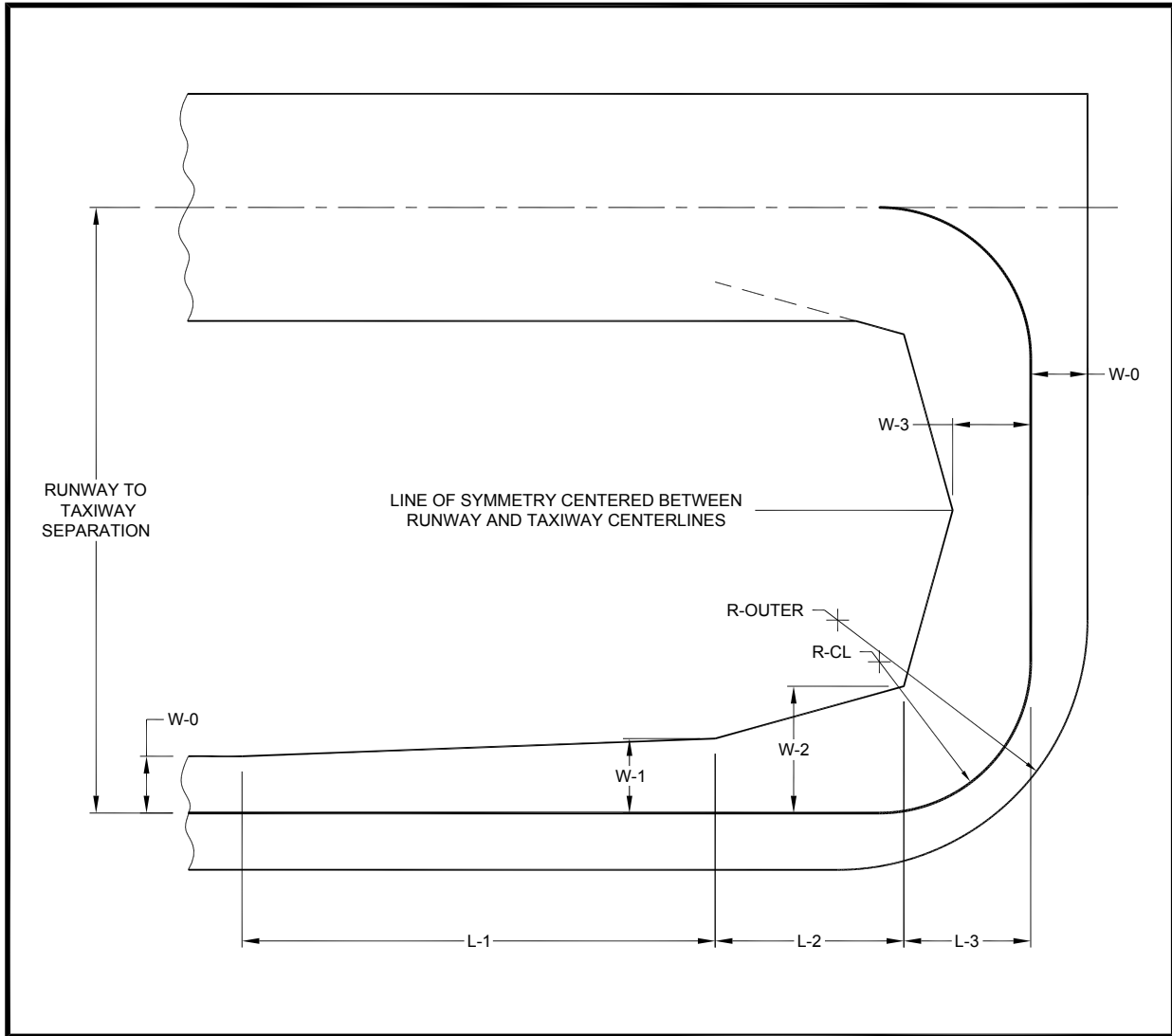
**408. Entrance taxiways.**

**a. Dual Use.** Each runway end must be served by an entrance taxiway, which also serves as the final exit taxiway for operations in the opposite direction. Connect entrance taxiways to the runway end at a right angle. Right-angle taxiways provide the best visual perspective to a pilot approaching an intersection with the runway to observe aircraft in both the left and right directions, on the runway and on approach. This design feature is critical at airports with or without control towers. The right-angle also provides for the optimum orientation of the runway holding position signs so they are visible to the taxiing aircraft.

**(1)** Two standard 90 degree turns resulting in a steering angle of 50 degrees or less: When the runway to taxiway separation is large enough to maintain a 50 degree or less steering angle through two standard 90 degree turns, a runway entrance taxiway is simply two standard 90 degree turns symmetrical about a line midway between the runway and taxiway centerlines.

**(2)** When two standard 90 degree turns would result in a steering angle of more than 50 degrees: When the runway to taxiway separation is narrow, it will be necessary to increase the turn radius and fillets. Table 4-12 provides necessary dimensions for common combinations of ADG, TDG, and runway to taxiways separation where the design requires other than two standard 90 degree turns. See Figure 4-17. An example of this condition is a right angle runway exit or entrance where the runway to taxiway separation is based on ADG-IV but the taxiways are designed for TDG-6. Drawings of such common combinations of TDG and runway to taxiway separation, with acceptable fillet design are available in DXF format on the

FAA web site at are available in DXF format on the FAA web site at: [http://www.faa.gov/airports/engineering/airport\\_design/](http://www.faa.gov/airports/engineering/airport_design/).



**Figure 4-17. Entrance taxiway**

**Table 4-12. Dimensions for runway entrance/exit taxiways (where the two 90-degree turns are nonstandard)**

Dimension (see <a href="#">Figure 4-17</a> )	TDG													
	2				4			5	6				7	
Runway Centerline to Taxiway Centerline Distance	240	250	300	350	300	350	400	400	400	450	500	550	500	550
W-0 (ft)	17.5	17.5	17.5	17.5	25	25	25	37.5	37.5	37.5	37.5	37.5	41	41
W-1 (ft)	27	27	26	26	34	38	37	49	53	53	54	54	55	55
W-2 (ft)	50	50	49	49	62	77	75	84	102	105	101	99	100	99
W-3 (ft)	28	27	25	24	49	43	38	52	63	58	53	50	54	52
L-1 (ft)	190	186	185	185	288	322	316	312	414	429	432	433	394	398
L-2 (ft)	75	75	75	75	125	128	130	125	175	164	155	150	154	150
L-3 (ft)	50	50	49	49	119	77	75	84	102	92	93	93	94	93
R-Fillet	0	0	0	0	90	0	0	0	0	0	0	0	0	0
R-CL (ft)	65	65	65	65	110	105	100	100	135	130	125	120	125	120
R-Outer	82	82	82	82	138	130	129	165	200	192	190	186	200	198

**b. Configuration.** The standard design of a runway entrance taxiway is at a right angle to the runway at the end of a runway where the threshold and beginning of takeoff coincide. Intersection angles of other than 90 degrees do not provide the best view of the runway and approach for a pilot at the holding position. A displaced threshold may require the holding position to be located along the parallel taxiway due to a need to keep aircraft out of the Precision Obstacle Free Zone (POFZ) and approach surfaces. This can lead to runway incursions when pilots do not expect to encounter the holding position away from its traditional location. The centerline radius and minimum fillet dimensions should comply with [Table 4-3](#) and the subsequent seven tables for TDG 1A, 1B, etc., respectively. The outer edge of an entrance taxiway must be curved. When multiple parallel taxiways extend to the end of the runway, the outer edge of the outer parallel taxiway must be curved.

**c. Design.** Do not design entrance taxiways to provide direct access from an apron, as shown in [Figure 4-2](#). Instead, configure taxiways as shown in [Figure 4-3](#). Design the entrance taxiway width based on [Table 4-2](#). The curved outer common edge, as discussed in paragraph [408.b](#) above, provides a visual clue to help pilots avoid landing on a parallel taxiway. Each entrance taxiway should have its own taxiway designator, markings and elevated signage. Existing entrance taxiways with non-standard design elements are to be corrected in accordance with this standard during the next capital project opportunity at that location. Designated hot-spot locations should receive priority attention. Ideally, the length of the entrance taxiway should allow the longest fuselage of a TDG, at the hold line, to fully line-up perpendicular to the

runway centerline to enhance visibility of runway operations and to improve the conspicuity of the runway markings and signs.

#### **409. Exit taxiways.**

Exit taxiways should permit free flow to the parallel taxiway or at least to a point where the aircraft is completely clear of the hold line.

**a. Exit angle.** Runway exit taxiways are classified as “right angle” or “acute angle.” When the design peak hour traffic is less than 30 operations (landings and takeoffs), a properly located right-angled exit taxiway will achieve an efficient flow of traffic. A decision to provide a right-angled exit taxiway or acute-angled exit taxiway rests upon an analysis of the existing and contemplated traffic. Advantages of a right angle exit taxiway are that it can be used for landings in both directions and as a runway crossing point. Avoid designs that encourage pilots to turn more than 90 degrees to exit the runway, as this abrupt angle requires the pilot to slow down considerably on the runway to negotiate the turn, resulting in additional runway occupancy time. Avoid designs that encourage use of an acute angle exit taxiway as a runway entrance or runway crossing point, as this does not provide a pilot with the best view of the runway in both directions.

**b. High-speed exit taxiways.** A specific case of an acute angle runway exit taxiway that forms a 30-degree angle with the runway centerline is commonly referred to as a “high speed” exit taxiway. The purpose of a high speed exit is to enhance airport capacity. Ideally, aircraft exiting the runway via a high speed exit taxiway should continue on the parallel taxiway in the landing direction. When it is necessary for aircraft to reverse direction to taxi to the ramp, either additional pavement must be provided, as shown in [Figure 4-18](#), or a second parallel taxiway with crossover taxiways must be constructed. Do not provide direct access from a high speed exit to another runway. Avoid providing access from a high speed exit to the outer of two parallel taxiways. The cost to construct high-speed exits is usually justified only on runways regularly serving aircraft in approach categories C and above.

**c. Separation.** The type of exit taxiway influences runway and taxiway separation. Interactive [Table 3-5](#) provides runway/taxiway separations based on ADG. However, minimum turn radii based on TDG may affect runway/taxiway separation distance. For existing runway/taxiway separations, it may not be possible to combine an initial 30 degree angle turn with a subsequent 150 degree turn while maintaining a nose gear steering angle of no more than 50 degrees. Design tools that can assist in such situations are available at: [http://www.faa.gov/airports/engineering/airport\\_design/](http://www.faa.gov/airports/engineering/airport_design/).

#### **d. Configuration.**

**(1) Right Angle Exits.** [Figure 4-19](#) illustrates the configuration for a right angle exit taxiway, which can be designed by creating a mirror image of an entrance taxiway about the exit taxiway centerline. For configurations other than those with two standard 90-degree turns, see [Table 4-12](#).

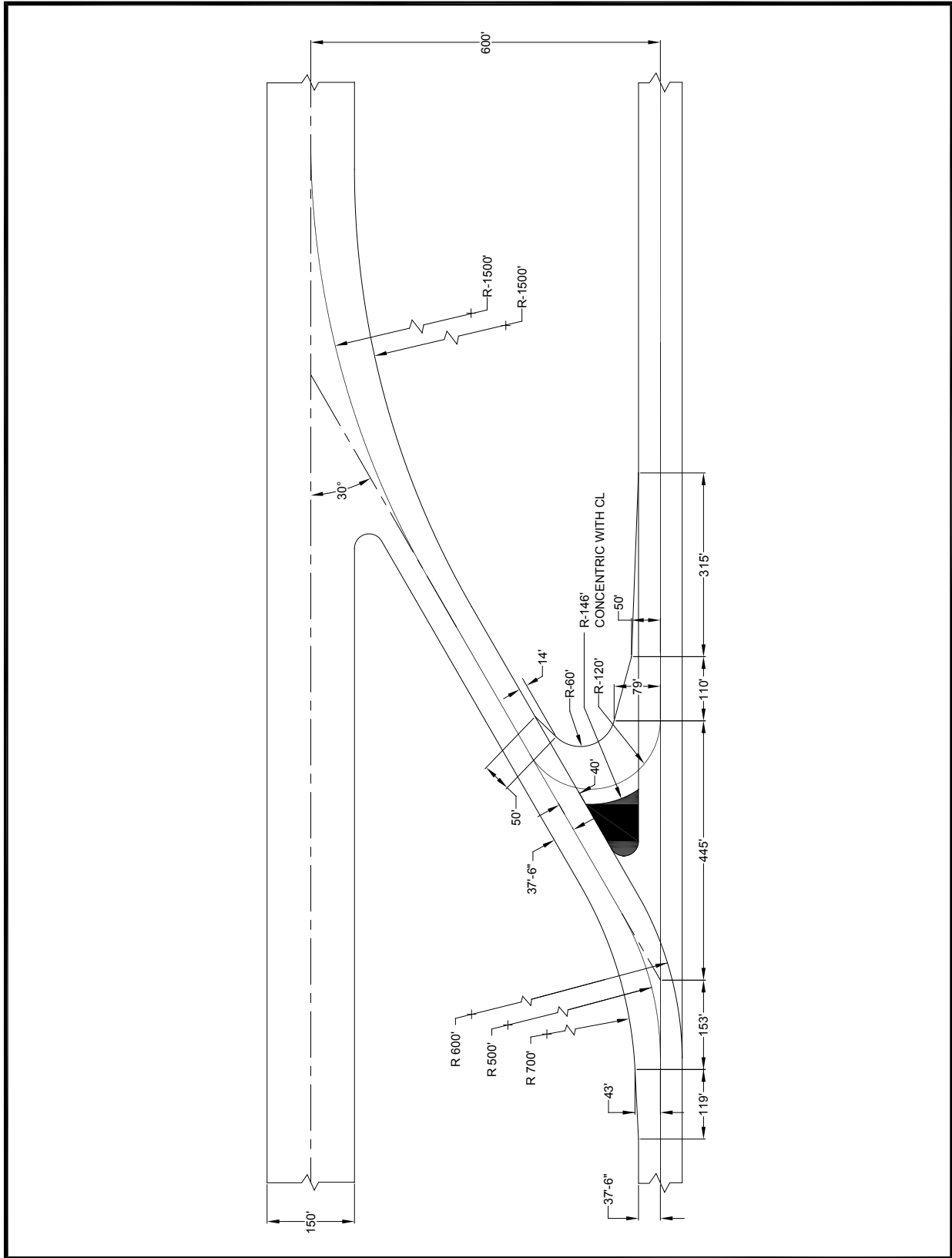
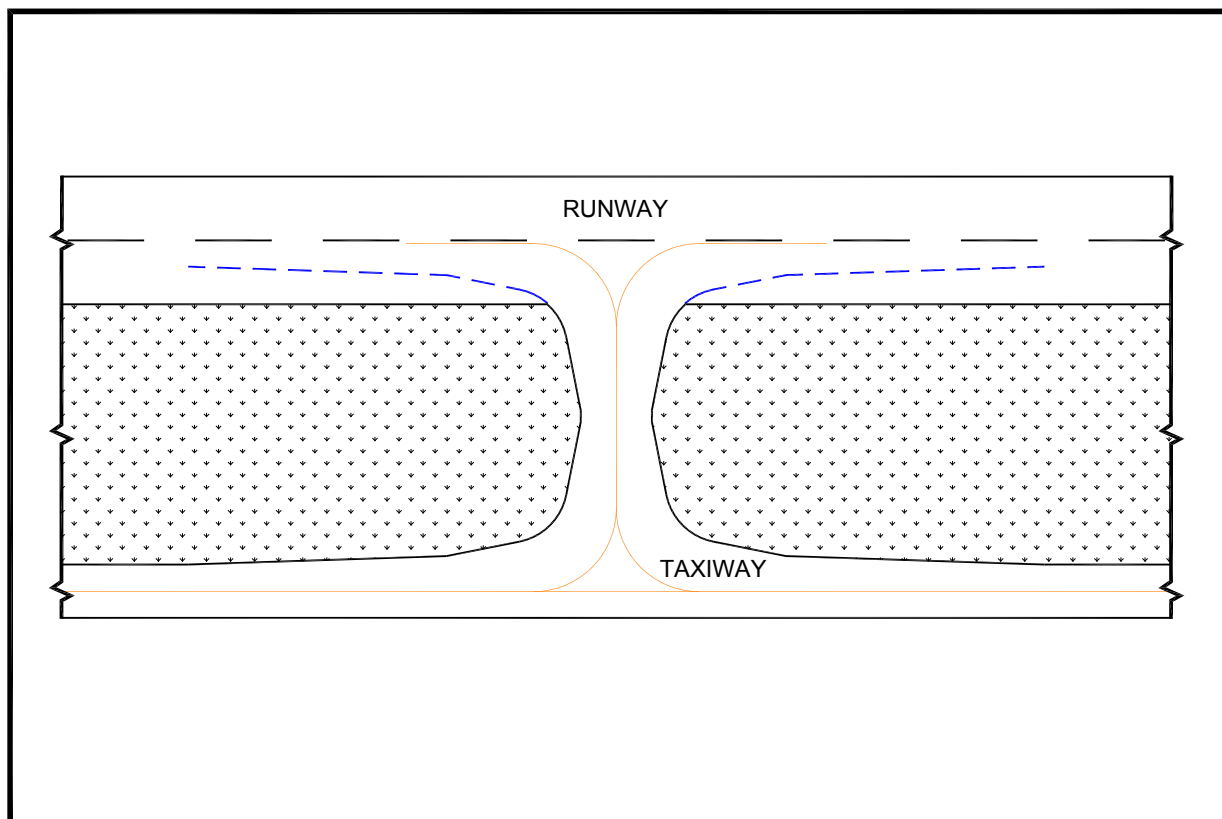


Figure 4-18. High speed exit for TDG-5



**Figure 4-19. Right-angled exit taxiway**

(2) High Speed Exits. Figure 4-18 illustrates a standard high-speed exit taxiway with a 30-degree angle of intersection. This figure and other drawings in DXF format showing common combinations of ADG, TDG, and runway to taxiway separation distance are available on the FAA web site at: [http://www.faa.gov/airports/engineering/airport\\_design/](http://www.faa.gov/airports/engineering/airport_design/). The radius of the exit from the runway should always be 1500 feet (457 m), as a pilot would not be able to discern the difference between a smaller radius and that of a standard high-speed exit, possibly resulting in excessive speed in the turn. Use Table 3-6 for an efficient high speed exit taxiway when it is necessary to include a curve for operations where the aircraft must taxi in the direction opposite from landing. In such a case, use the greater dimension based on ADG or TDG. If a back turn is necessary when the runway to taxiway separation is less than shown in Table 3-6, it is necessary to decrease the initial exit angle and/or use a radius that will require a nose gear steering angle of more than 50 degrees for longer aircraft and to increase pavement fillets. (See paragraph 406.b(1) for guidance on fillet design.) Such sharp turns may require locked wheel turns and/or differential engine thrust and result in excessive tire wear. Note that in all cases the fillet for the reverse turn is designed considering that the exit taxiway is “one way.” When runway capacity needs justify the additional cost, high visibility taxiway centerline lights can be added and the exit taxiway widened by doubling the TESM for the entire exit taxiway or by tapering the TESM from double at the intersection with the runway to normal at the intersection with the parallel taxiway. These design enhancements will increase pilot acceptance of an exit. They will require modeling all the critical combinations of CMG, MGW, and TESM for the TDG. Do not co-locate opposite direction high speed exit taxiways as shown

in [Figure 4-20](#) as the wide expanse of pavement adjacent to the runway precludes proper lighting and signs. Instead, separate high speed exit taxiways as shown in [Figure 4-21](#).

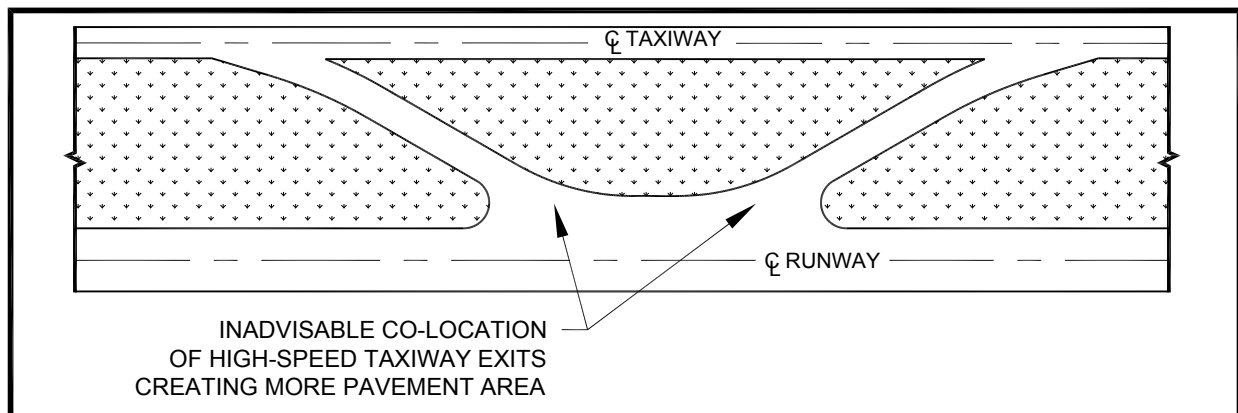
**e. Exit taxiway location.** [AC 150/5060-5](#) provides guidance on the effect of exit taxiway location on runway capacity. [Table 4-13](#) presents cumulative percentages of aircraft observed exiting existing runways at specific exit taxiway locations. In general, each 100-foot (30 m) reduction of the distance from the threshold to the exit taxiway reduces the runway occupancy time by approximately 0.75 second for each aircraft using the exit. Conversely, the runway occupancy time of each additional aircraft now overrunning the new exit location is increased by approximately 0.75 second for each 100 feet (30 m) from the old location to the next available exit. For example, the percent of aircraft exiting at or before an exit located 4,000 feet (1219 m) from the threshold are:

(1) When the runway is wet, 100 percent of small, single engine aircraft (S), 80 percent of small, twin engine aircraft (T), 1 percent of large aircraft up to 300,000 lbs (L), and 0 percent of large aircraft over 300,000 lbs (H) aircraft;

(2) When the runway is dry and the exit is right angled, 100 percent of S, 98 percent of T, 8 percent of L, and 0 percent of H aircraft; and

(3) When the runway is dry and the exit is acute angled, 100 percent of S, 98 percent of T, 26 percent of L, and 3 percent of H aircraft.

When selecting the location and type of exit, both the wet and dry runway conditions along with a balance between increases and decreases in runway occupancy time should be considered. [Table 4-13](#) does not include any correction for elevation.



**Figure 4-20. Poor design of high speed exits**



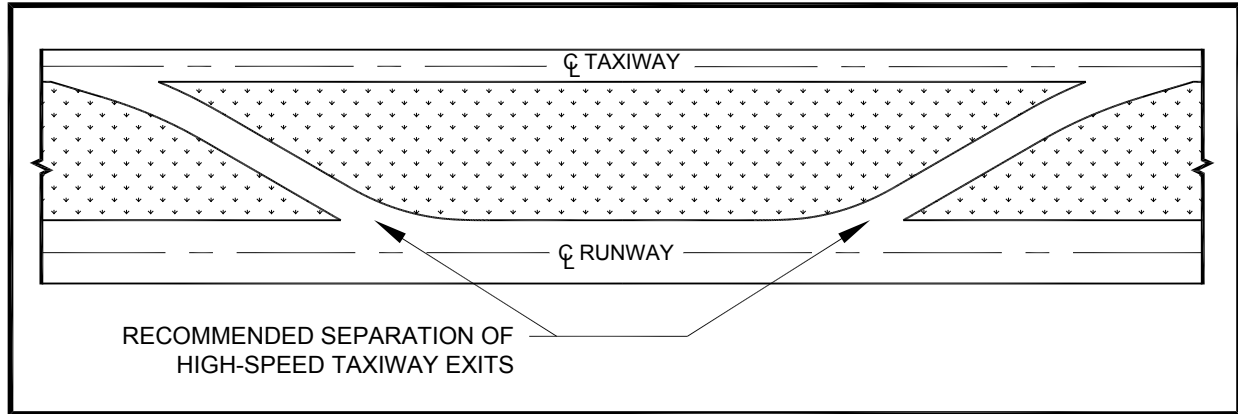


Figure 4-21. Proper design of high speed exits

Table 4-13. Exit taxiway cumulative utilization percentages

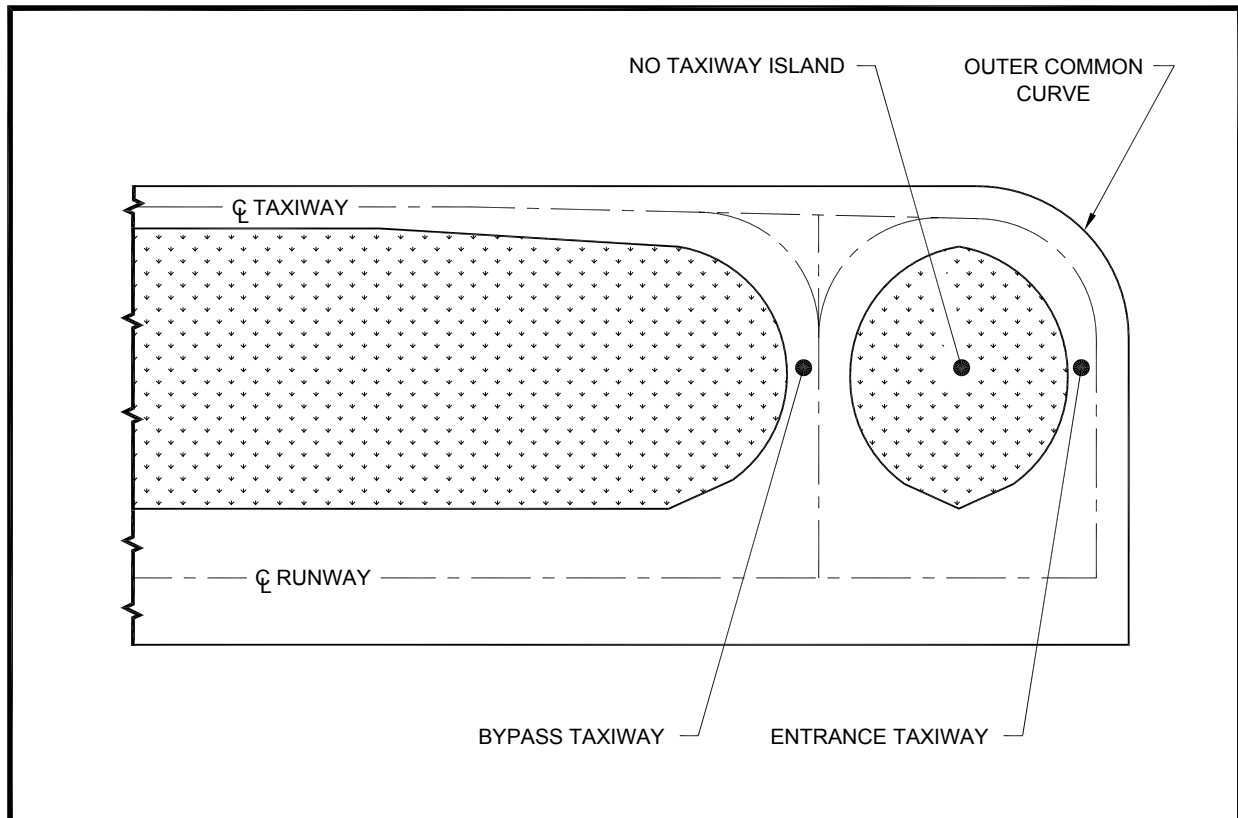
DISTANCE THRESHOLD TO EXIT	WET RUNWAYS				DRY RUNWAYS								
	RIGHT & ACUTE ANGLED EXITS				RIGHT ANGLED EXITS				ACUTE ANGLED EXITS				
	S	T	L	H	S	T	L	H	S	T	L	H	
0 ft (0 m)	0	0	0	0	0	0	0	0	0	0	0	0	0
500 ft (152 m)	0	0	0	0	0	0	0	0	1	0	0	0	0
1,000 ft (305 m)	4	0	0	0	6	0	0	0	13	0	0	0	0
1,500 ft (457 m)	23	0	0	0	39	0	0	0	53	0	0	0	0
2,000 ft (610 m)	60	0	0	0	84	1	0	0	90	1	0	0	0
2,500 ft (762 m)	84	1	0	0	99	10	0	0	99	10	0	0	0
3,000 ft (914 m)	96	10	0	0	100	39	0	0	100	40	0	0	0
3,500 ft (1067 m)	99	41	0	0	100	81	2	0	100	82	9	0	0
4,000 ft (1219 m)	100	80	1	0	100	98	8	0	100	98	26	3	0
4,500 ft (1372 m)	100	97	4	0	100	100	24	2	100	100	51	19	0
5,000 ft (1524 m)	100	100	12	0	100	100	49	9	100	100	76	55	0
5,500 ft (1676 m)	100	100	27	0	100	100	75	24	100	100	92	81	0
6,000 ft (1829 m)	100	100	48	10	100	100	92	71	100	100	98	95	0
6,500 ft (1981 m)	100	100	71	35	100	100	98	90	100	100	100	99	0
7,000 ft (2134 m)	100	100	88	64	100	100	100	98	100	100	100	100	0
7,500 ft (2286 m)	100	100	97	84	100	100	100	100	100	100	100	100	0
8,000 ft (2438 m)	100	100	100	93	100	100	100	100	100	100	100	100	0
8,500 ft (2591 m)	100	100	100	99	100	100	100	100	100	100	100	100	0
9,000 ft (2743 m)	100	100	100	100	100	100	100	100	100	100	100	100	0

Notes:

- S - Small, single engine                      12,500 lbs (5670 kg) or less
- T - Small, twin engine                        12,500 lbs (5670 kg) or less
- L - Large    12,500 lbs (5670 kg) to 300,000 lbs (136080 kg)
- H - Heavy     > 300,000 lbs

#### 410. Bypass taxiways.

ATC personnel at busy airports encounter occasional bottlenecks when moving aircraft ready for departure to the desired takeoff runway. Bottlenecks result when a preceding aircraft is not ready for takeoff and blocks the access taxiway. Bypass taxiways provide flexibility in runway use by permitting ground maneuvering of steady streams of departing aircraft. An analysis of existing and projected traffic should be performed to indicate if a bypass taxiway will enhance traffic flow. Bypass taxiways are located at or near the runway end. They must be parallel to, and maintain a standard taxiway to taxiway separation from, the main entrance taxiway serving the runway, as shown in [Figure 4-22](#), or used in combination with the dual parallel taxiways as depicted in [Figure 4-12](#). They should also conform to the standard width for the specific TDG, as shown in [Table 4-2](#). The standard design is not to pave the area between the bypass taxiway and entrance taxiway. Existing paved islands between the entrance taxiway and the bypass taxiway must be marked to clearly identify the area as closed to aircraft. Constructability and maintenance concerns may make the use of artificial turf for this application economical. Each bypass taxiway should have its own taxiway designator, markings and elevated signage. Existing bypass taxiways with non-standard design elements are to be corrected in accordance with this standard during the next capital project opportunity at that location. Designated hot-spot locations should receive priority attention.



**Figure 4-22. Bypass taxiway**

#### 411. Crossover taxiways.

Crossover taxiways, sometimes called “connector” or “transverse” taxiways, between parallel taxiways increase flexibility. The design of the taxiway system should minimize the need for direction reversal between taxiways (180 degree turns), as these require a wide expanse of pavement that makes signing less effective. Avoid aligning crossover taxiways with entrance or exit taxiways.

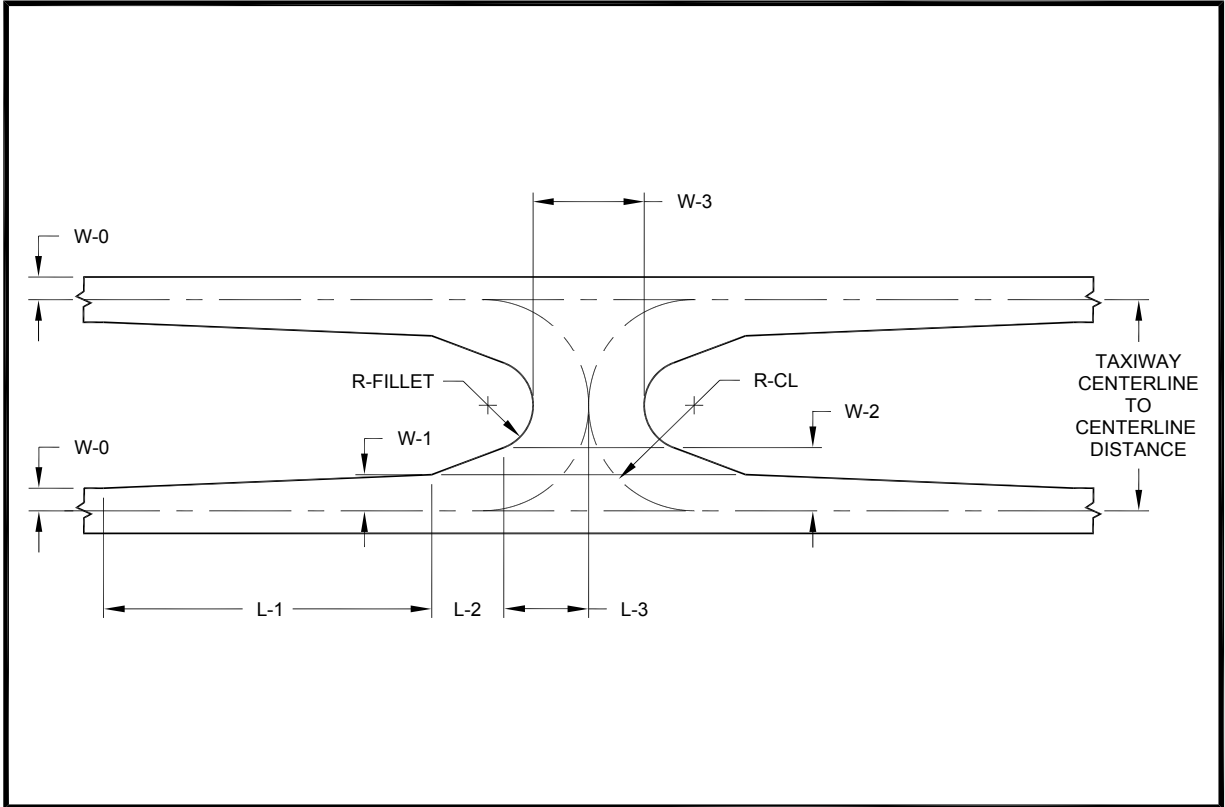
##### a. Crossover taxiways with direction reversal.

(1) **New Construction.** The minimum distance between parallel taxiways is based on ADG (see [Table 4-1](#)), but this dimension may need to be increased based on TDG (see [Table 4-14](#)) when direction reversal between taxiways (180 degree turn) is necessary. This is due to the need to avoid steering angles of more than 50 degrees. [Table 4-14](#) provides dimensions used in [Figure 4-23](#) for this situation. In some cases where the separation is based on ADG, a steering angle of more than 50 degrees may still result from combining two 90 degree turns designed according to [Table 4-3](#) (and the subsequent seven tables). [Table 4-15](#) provides dimensions used in [Figure 4-24](#) for common combinations of ADG and TDG for crossover taxiways where steering angles may be kept to no more than 50 degrees.

(2) **Existing Taxiways.** It is often not feasible to increase the separation between existing parallel taxiways, and a steering angle of more than 50 degrees must be accepted. [Table 4-15](#) also provides dimensions used in [Figure 4-24](#) for this situation.

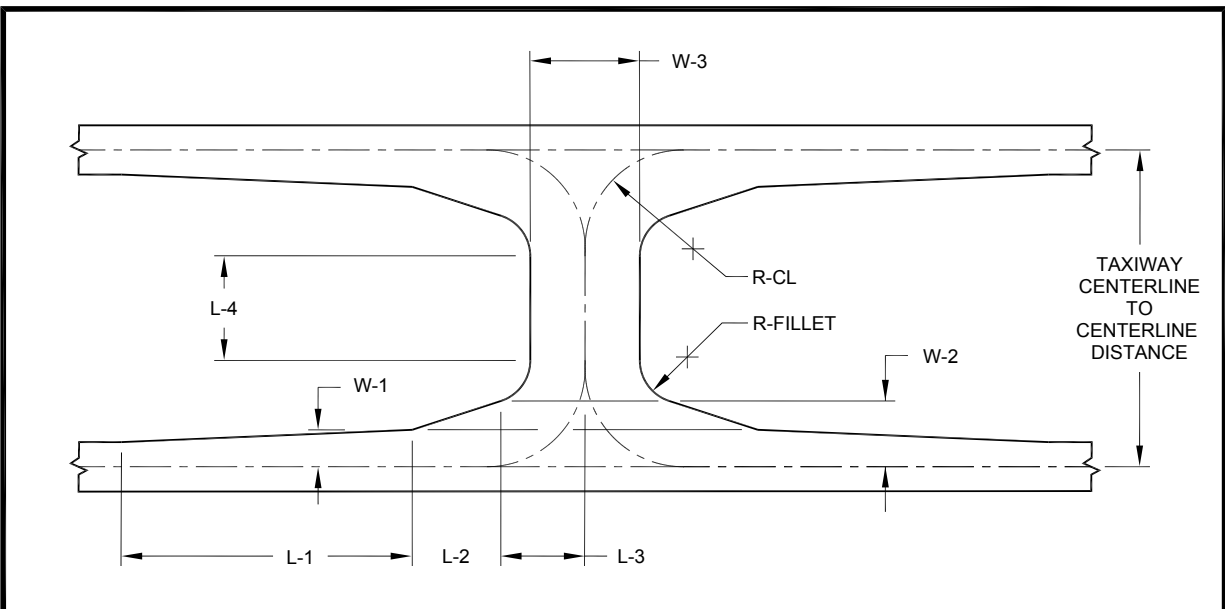
**Table 4-14. Crossover taxiways with direction reversal between taxiways based on TDG**

Dimension (See <a href="#">Figure 4-23</a> )	TDG							
	1A	1B	2	3	4	5	6	7
<b>Taxiway Centerline to Centerline Distance</b>	70	105	162	162	240	240	312	312
<b>W-0 (ft)</b>	12.5	12.5	17.5	25	25	37.5	37.5	41
<b>W-1 (ft)</b>	20	20	28	36	43	53	56	56
<b>W-2 (ft)</b>	20	34	53	62	83	87	109	109
<b>W-3 (ft)</b>	37	57	90	104	138	168	180	180
<b>L-1 (ft)</b>	48	106	198	198	355	340	438	400
<b>L-2 (ft)</b>	0	35	65	65	100	100	150	150
<b>L-3 (ft)</b>	31	41	65	65	94	108	123	123
<b>R-Fillet (ft)</b>	15	20	30	20	40	35	50	50
<b>R-CL (ft)</b>	35	52.5	81	81	120	120	156	156



Note: Refer to [Table 4-14](#).

**Figure 4-23. Crossover taxiway where direction reversal is needed based on TDG**



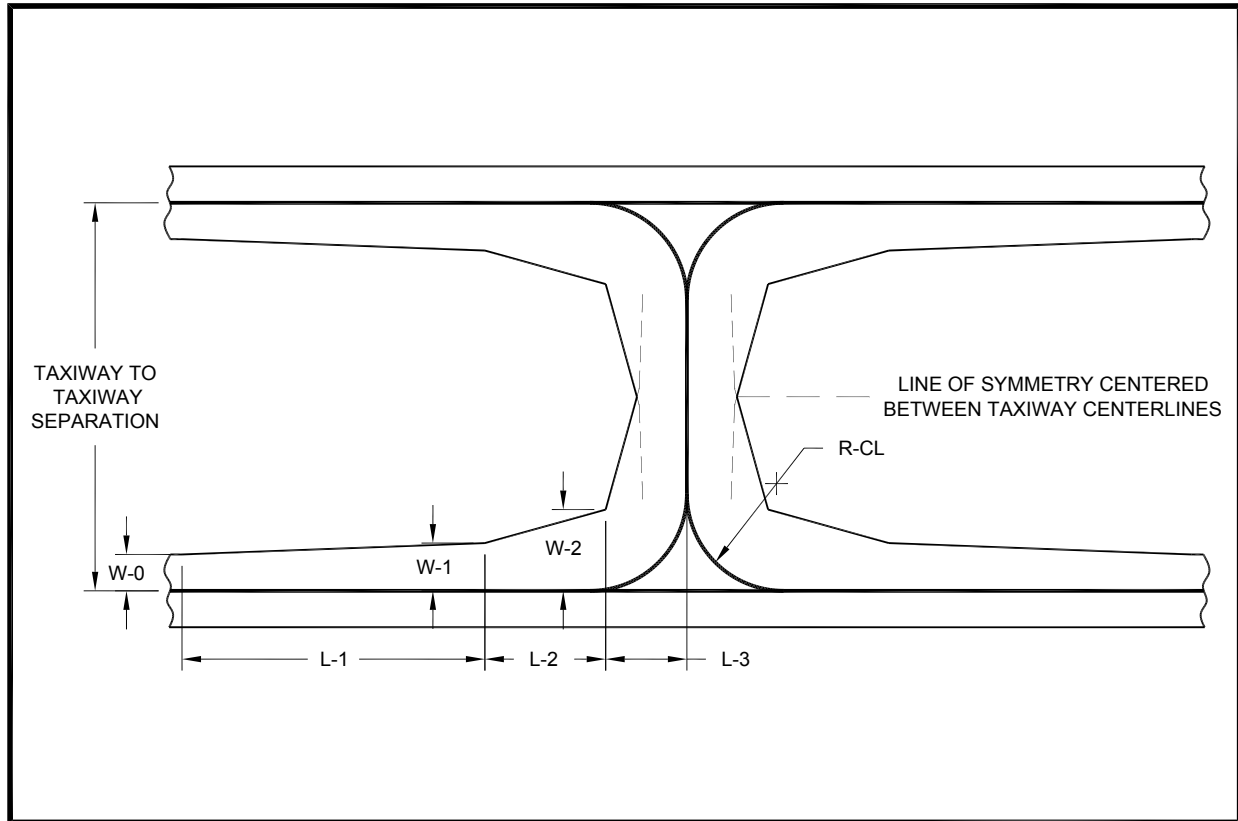
Note: Refer to [Table 4-15](#).

**Figure 4-24. Crossover taxiway where direction reversal is necessary based on ADG**

**Table 4-15. Crossover taxiways with direction reversal between taxiways based on ADG**

Dimension (see <a href="#">Figure 4-24</a> )	TDG										
	2	3	4	5	6	7					
	ADG										
	III	IV	III	IV	IV	IV	V	V	VI	V	VI
<b>Taxiway Centerline to Centerline Distance</b>	152	215	152	215	215	215	267	267	324	267	324
<b>W-0 (ft)</b>	17.5	17.5	25	25	25	37.5	37.5	37.5	37.5	41	41
<b>W-1 (ft)</b>	28	33	38	43	45	57	54	61	56	61	56
<b>W-2 (ft)</b>	53	33	62	43	89	94	86	120	100	120	100
<b>W-3 (ft)</b>	96	65	109	78	149	179	141	200	167	200	167
<b>L-1 (ft)</b>	198	213	210	217	366	359	347	476	444	433	404
<b>L-2 (ft)</b>	65	0	55	0	96	90	90	130	135	130	135
<b>L-3 (ft)</b>	64	102	64	98	86	99	104	109	128	109	128
<b>L-4 (ft)</b>	0	75	0	75	0	0	27	0	24	0	24
<b>R-Fillet (ft)</b>	25	75	15	65	20	15	50	15	65	15	65
<b>R-CL (ft)</b>	76	70	76	70	107.5	107.5	120	133.5	150	133.5	150
<b>Steering Angle (degrees)</b>	54	50	54	50	59	59	50	66	54	50	50

**b. Crossover taxiways without direction reversal.** When a crossover taxiway is not designed for direction reversal from a taxiway to a parallel taxiway the centerline to centerline separation of the parallel taxiways is equal to twice the radius of a standard 90 degree turn or the separation required by the ADG, whichever is greater. The fillets for such crossover taxiways may always be based on standard 90 degree turns (see [Figure 4-25](#)).



**Note:** Refer to [Table 4-3](#) and the subsequent seven tables for TDG 1A, 1B, etc., respectively.

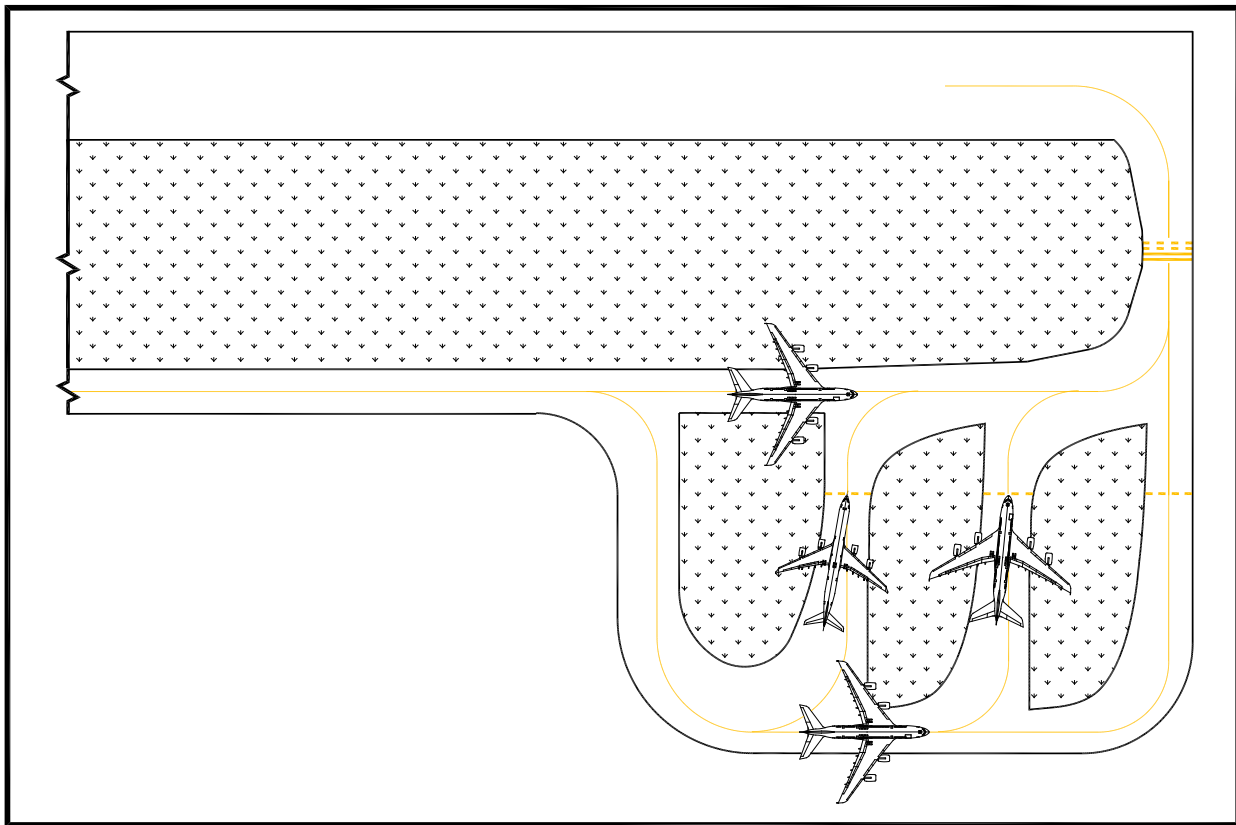
**Figure 4-25. Crossover taxiway without direction reversal between taxiways**

#### 412. Holding bays for runway ends.

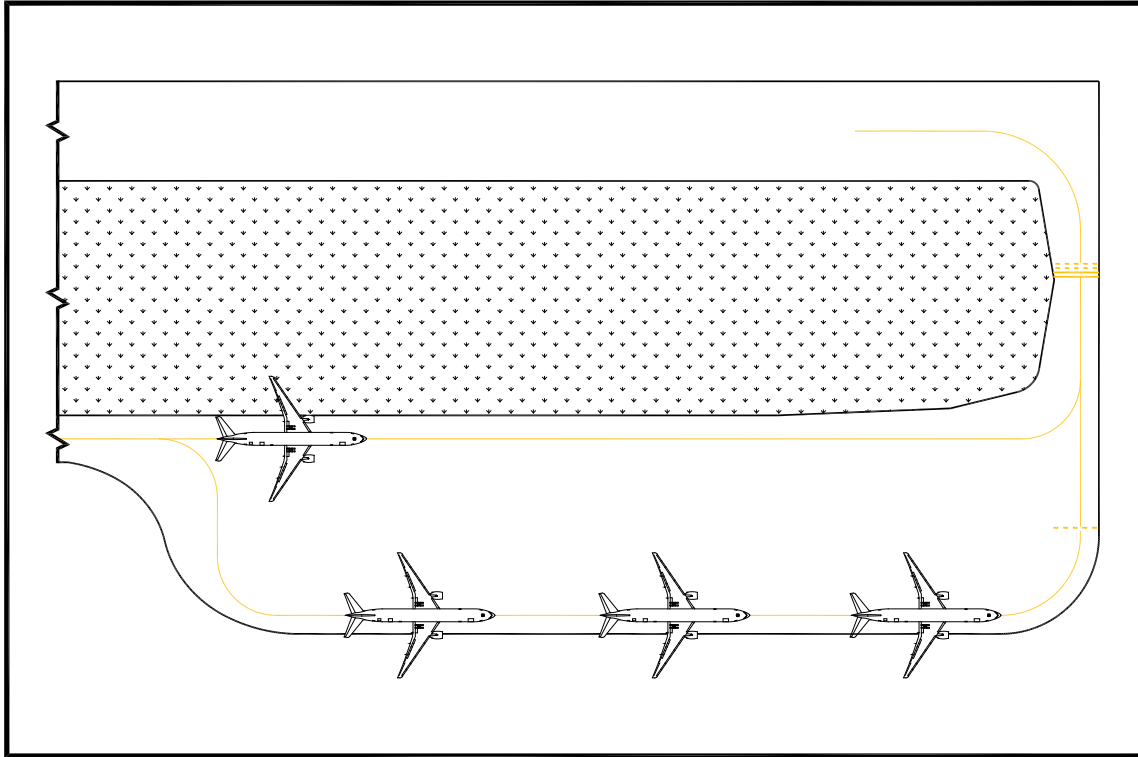
Providing holding bays instead of bypass taxiways can enhance capacity. Holding bays provide a standing space for aircraft awaiting clearance and to permit those aircraft already cleared to move to their runway takeoff position. A holding bay should be provided when runway operations reach a level of 30 per hour.

**a. Location.** Although the most advantageous position for a holding bay is adjacent to the taxiway serving the runway end, it may be satisfactory in other locations. Place holding bays to keep aircraft out of the Obstacle Free Zone (OFZ), POFZ, and the Runway Safety Area (RSA), as well as avoid interference with Instrument Landing Systems (ILSs).

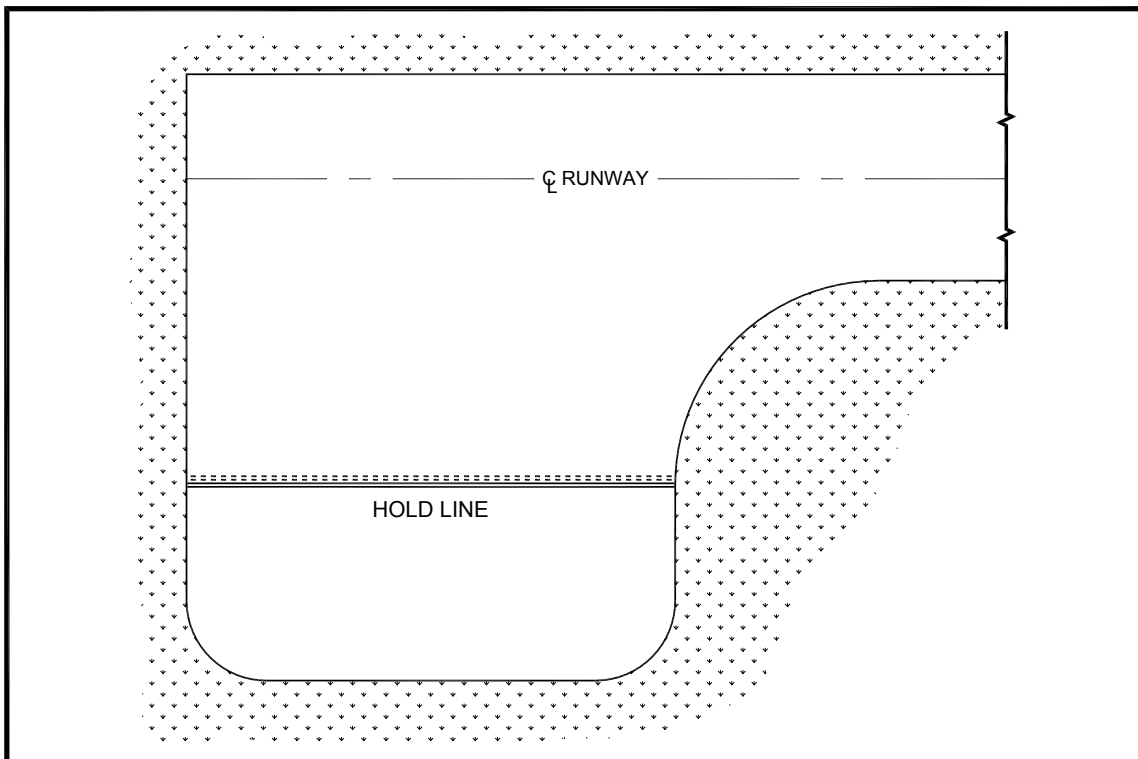
**b. Design.** Holding bays should be designed to allow aircraft to bypass one another to taxi to the runway. Figure 4-26 shows a typical holding bay configuration with clearly marked entrances/exits. Each parking area is independent, with the ability for aircraft to bypass others both on entrance and exit. Islands between the parking positions provide additional cues to pilots, and costs may be saved if the decrease in pavement offsets the increased complexity of construction. Taxiway wingtip clearance is assured. Note that with the typical tight turns required, holding aircraft will often not be in line with the taxiway centerline. Figure 4-27 shows a holding bay with an undesirable wide expanse of pavement adjacent to the taxiway. Aircraft entering the holding bay stack up nose to tail. They can exit independently, but there are no markings to ensure wingtip clearance. Figure 4-28 depicts a particularly poor design of a holding bay, with a long hold line and no other markings.



**Figure 4-26. Typical holding bay configuration**



**Figure 4-27. Holding bay – not recommended design**



**Figure 4-28. Poor holding bay design**



### 413. Taxiway turnarounds.

At low traffic general aviation airports, turnarounds may be considered during initial runway development as an alternative to a full or partial parallel taxiway (see Figure 4-29). The geometry of the turnaround must be consistent with the applicable ADG and TDG. The designer must weigh whether initial construction of a turnaround is the best option for the airport because a moderate increase in cost may allow the construction of a partial parallel taxiway, which could be expanded as the airport's needs grow.

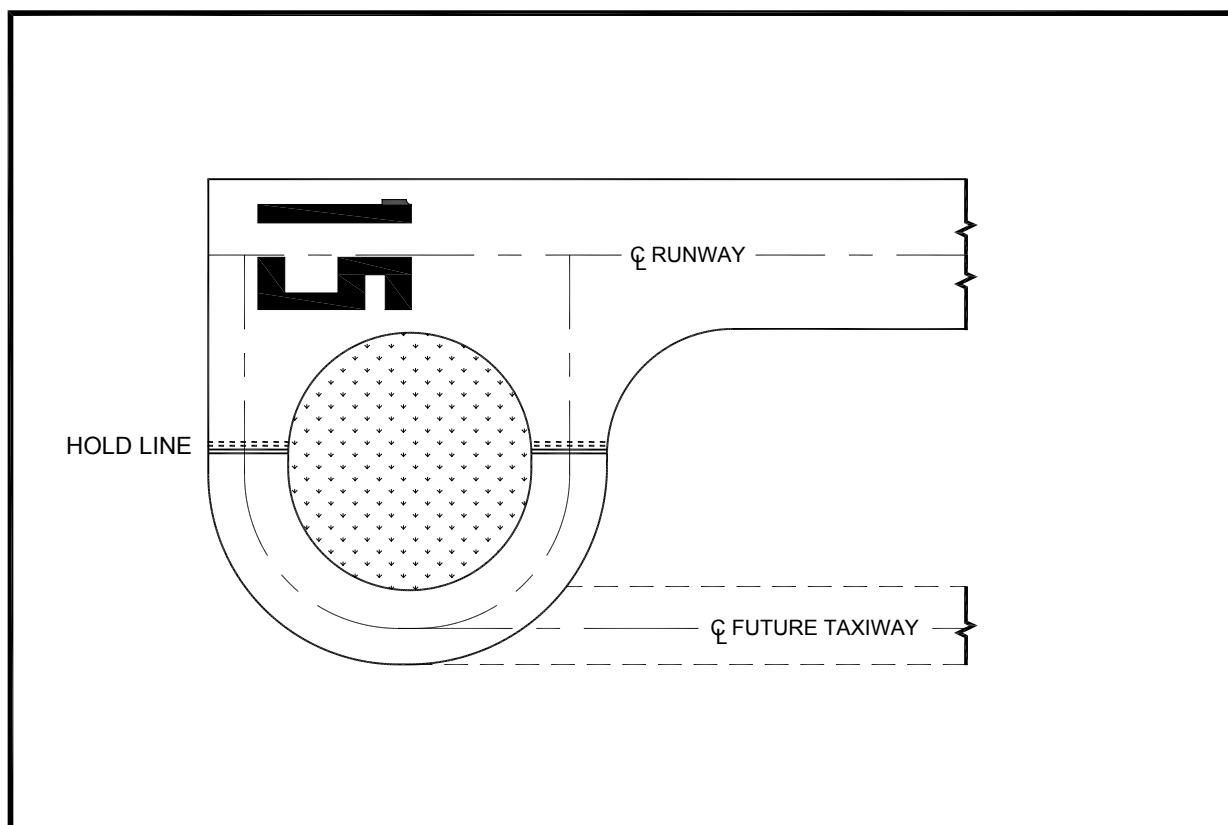


Figure 4-29. Taxiway turnaround

### 414. Apron taxiways and taxilanes.

There is often a need for through-taxi routes across an apron and to provide access to gate positions or other terminal areas. ATCT personnel require a clear line of sight (LOS) to all apron taxiways and taxilanes under their control. For taxilanes not under their control, a clear LOS to taxilanes is desirable.

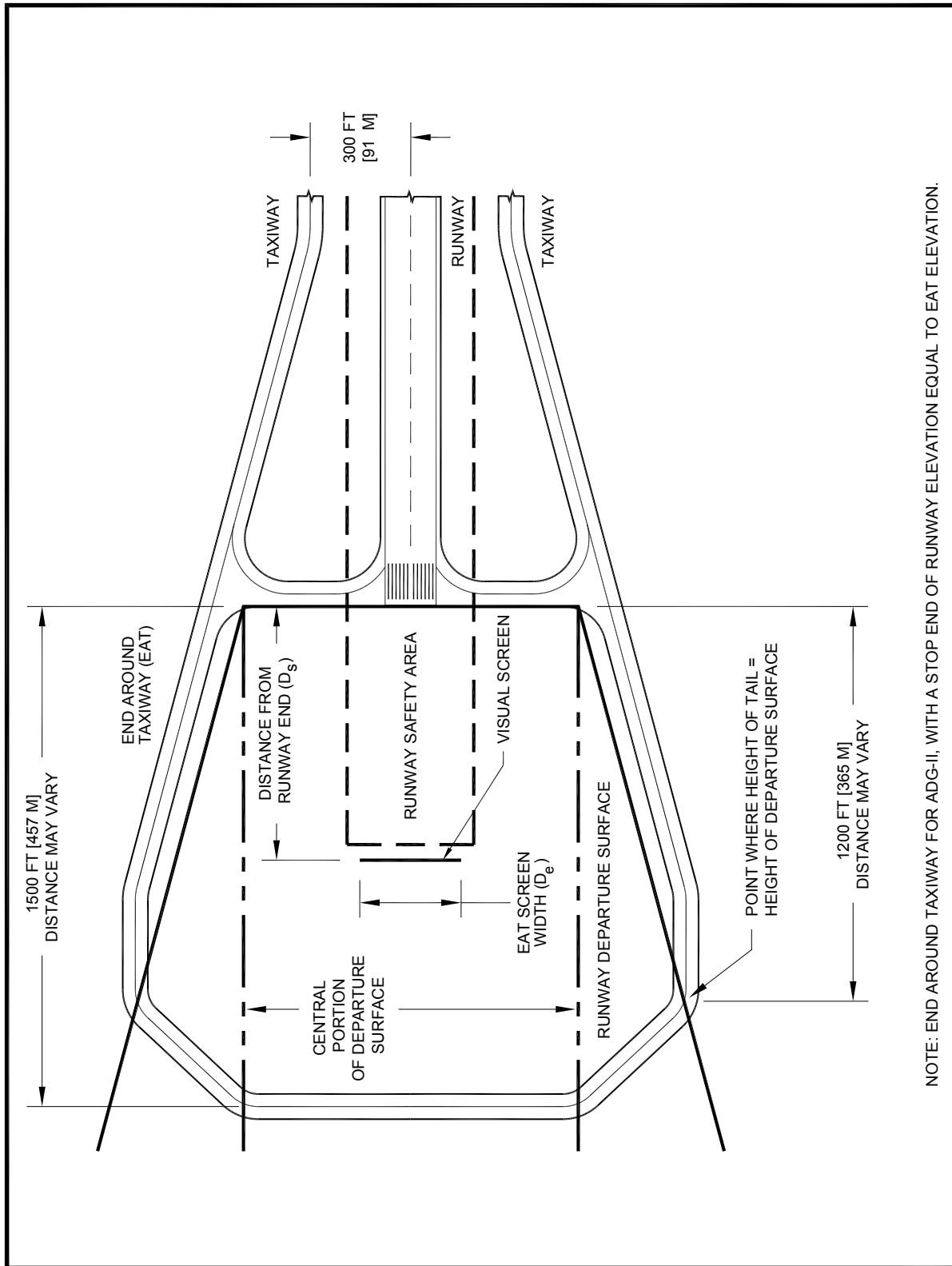
**a. Apron taxiways.** Apron taxiways may be located either inside or outside the movement area. Apron taxiways require the same separations as other taxiways. When an apron taxiway is along the edge of the apron, locate its centerline inward from the apron edge at a distance equal to one-half the width of the required taxiway width. Shoulder, safety area, and obstacle free area requirements apply along the outer edge.

**b. Taxilanes.** Taxilanes are usually, but not always, located outside the movement area, providing access from taxiways (usually an apron taxiway) to aircraft parking positions and other terminal areas. Taxilanes are designed for low speed and precise taxiing. It is these considerations that make reduced clearances acceptable. The anticipated use of the pavement determines whether taxiway or taxilane design standards apply. When the taxilane is along the edge of the apron, locate its centerline inward from the apron edge at a distance equal to one-half of the required width of a taxiway. Shoulder, safety area, and obstacle free area requirements apply along the outer edge.

#### **415. End-Around Taxiways (EAT).**

In an effort to increase operational capacity, airports have added dual and sometimes triple parallel runways, which can cause delays when outboard runway traffic has to cross active inboard runways to make its way to the terminal. To improve efficiency and provide a safe means of movement from one side of a runway to the other, it might be feasible to construct a taxiway that allows aircraft to taxi around the end of the runway. When constructed to allow an aircraft to cross the extended centerline of the runway without specific clearance from ATC, this type of taxiway is called an EAT. See [Figure 4-30](#). These operations may introduce certain risks, so it is necessary for planners to work closely with the FAA prior to considering the use of an EAT. Before EAT projects are proposed and feasibility studies and/or design started, they must be pre-approved by the FAA Office of Airport Safety and Standards, Airport Engineering Division (AAS-100). Submission for project approval is through the local FAA Airports Regional or District Office.

**a. Design considerations.** The centerline of an EATs must be a minimum of 1,500 feet (457 m) from the stop end of the runway for a minimum of 500 feet each side of the extended runway centerline, as shown in [Figure 4-30](#). These minimum dimensions are increased if necessary to prevent aircraft tails from penetrating the 40:1 departure surface and any surface identified in [Order 8260.3](#), as shown in [Figure 4-31](#). The design will be based on the relative elevations of the stop end of the runway and EAT and the aircraft tail height. It will often be advantageous to construct the EAT at a lower elevation than the stop end of the runway, as this may reduce the minimum distance between the end of the runway and the portion of the EAT perpendicular to the extended runway centerline. An airspace study for each site will be performed to verify that the tail height of the critical design group aircraft operating on the EAT does not penetrate the 40:1 departure surface and any surface identified in [Order 8260.3](#). The study will also confirm compliance with [Part 121](#), §121.189, Airplanes: Turbine Engine Powered: Takeoff Limitations. This section requires the net takeoff flight path to clear all obstacles either by a height of at least 35 feet (10.5 m) vertically, or by at least 200 feet (61 m) horizontally within the airport boundaries. In addition, the EAT must be entirely outside of any ILS critical area. [Figure 4-30](#) and [Figure 4-31](#) are intended to illustrate a concept, not a standard design. Each EAT must be designed based on parameters unique to each airport and each runway.



NOTE: END AROUND TAXIWAY FOR ADG-II, WITH A STOP END OF RUNWAY ELEVATION EQUAL TO EAT ELEVATION.

Figure 4-30. End-Around Taxiway (EAT) – ADG-II

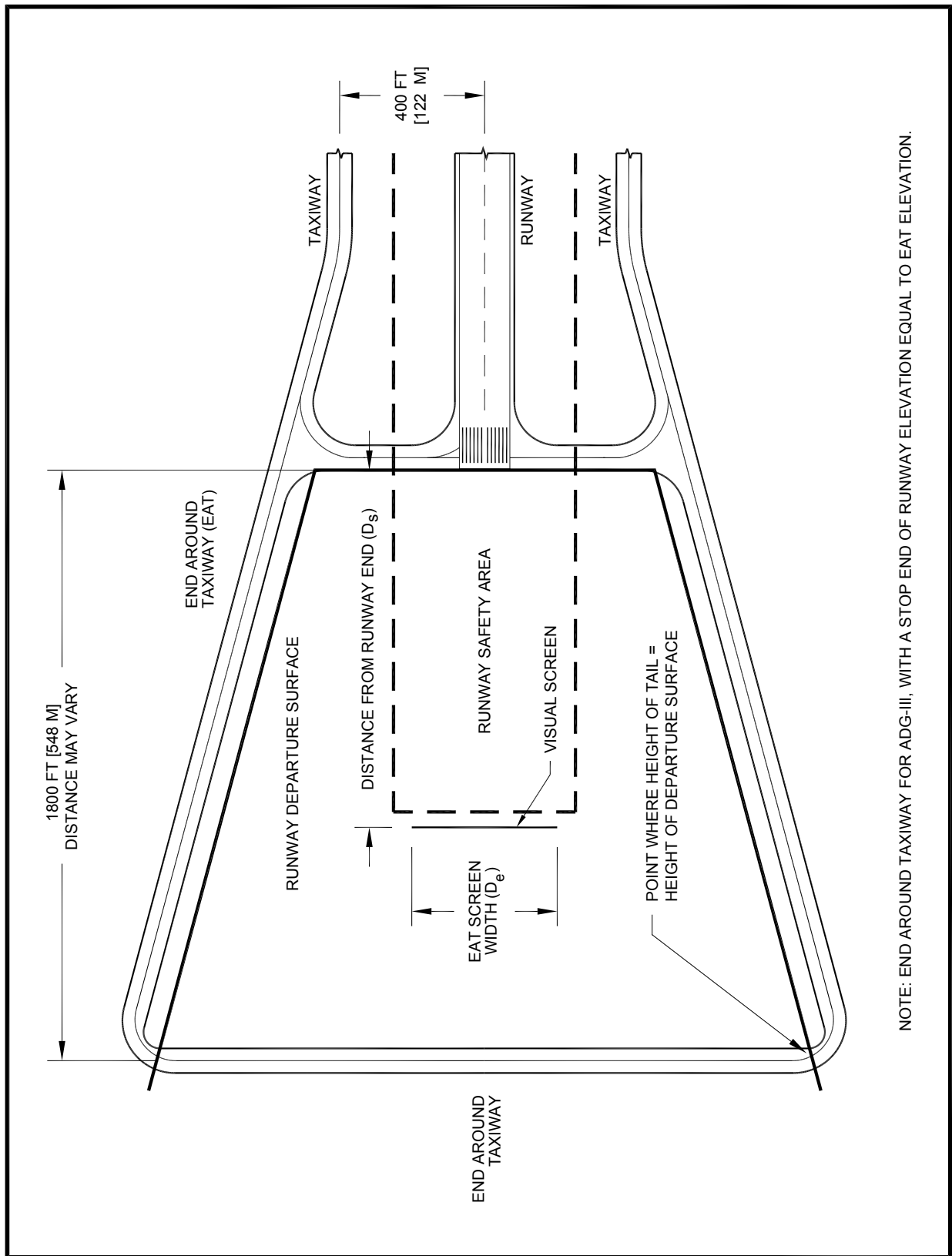


Figure 4-31. EAT – ADG-III

**b. Visual screen.** The placement and configuration of EATs must take into account additional restrictions to prevent interfering with Navigation Aids (NAVAIDs), approaches and departures from the runway(s) with which they are associated. In order to avoid potential issues where pilots departing from a runway with an EAT might mistake an aircraft taxiing on the EAT for one actually crossing near the stop end of the runway, a visual screen may be required, depending on the elevation changes at a specific location. Through a partial or complete masking effect, the visual screen will enable pilots to better discern when an aircraft is crossing the active runway versus operating on the EAT. The intent is to eliminate any false perceptions of runway incursions, which could lead to unnecessary aborted takeoffs, and alert pilots to actual incursion situations. Research has shown that “masking” is accomplished at a height where the wing-mounted engine nacelle of an aircraft on the EAT would be blocked from view as discerned from the  $V_1$  point during takeoff. Do not locate the visual screen structure within any RSA, taxiway OFA, or ILS critical area. The screen also must not penetrate the inner approach OFZ, the approach light plane or other Terminal Instrument Procedures (TERPS) surfaces. The design of the visual screen and siting of visual aids are co-dependent. Refer to Appendix 4 for detailed planning and design standards guidance on EAT screens.

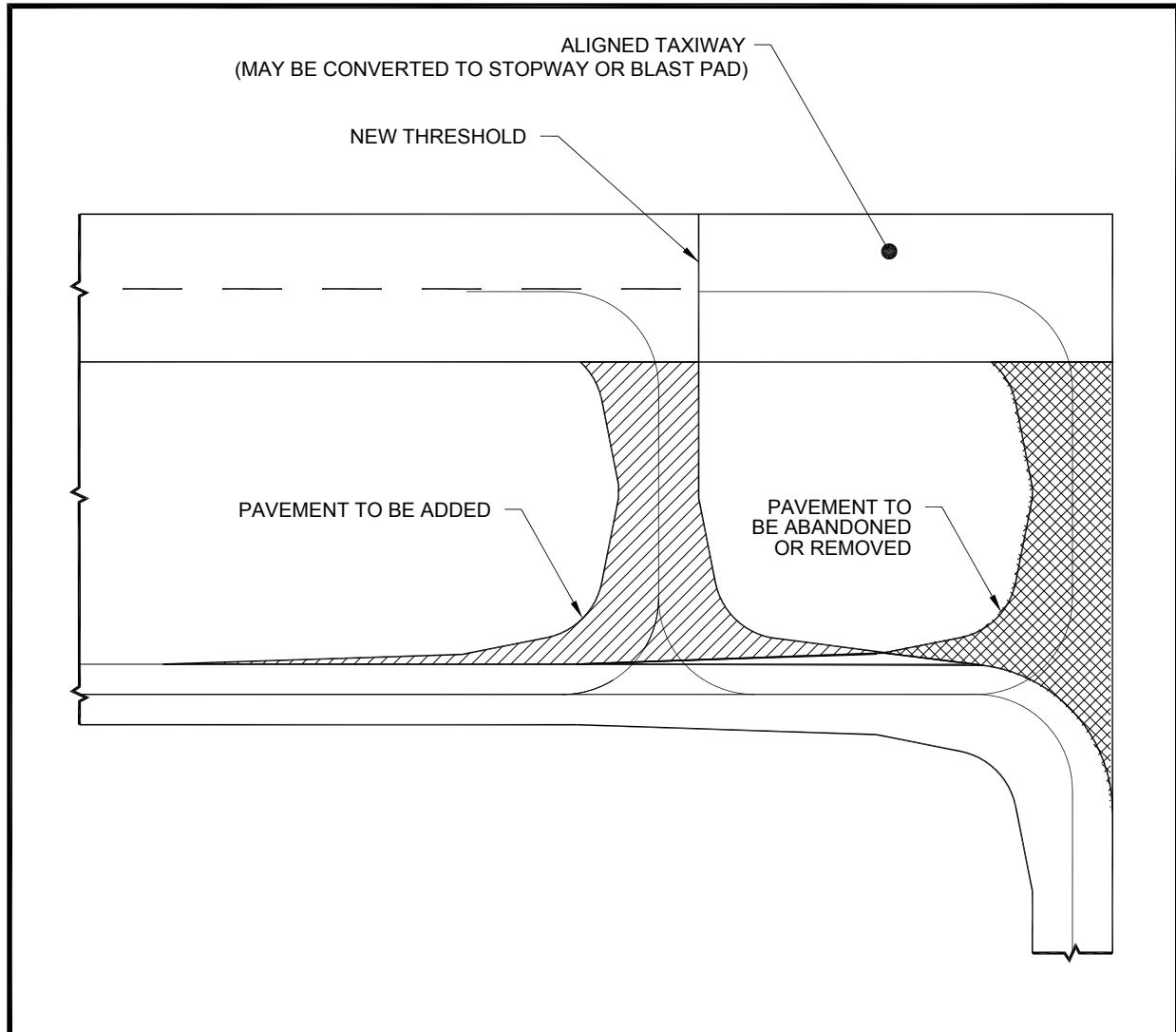
#### **416. Aligned taxiways prohibited.**

An aligned taxiway is one whose centerline coincides with a runway centerline. Such taxiways have often been established due to the relocation of a runway end without constructing a new entrance taxiway at the new threshold. This places a taxiing aircraft in direct line with aircraft landing or taking off. The resultant inability to use the runway while the taxiway is occupied, along with the possible loss of situational awareness by a pilot, preclude the design of these taxiways. Existing aligned taxiways should be removed as soon as practicable. Any abandoned pavement should preferably be removed, but at a minimum appropriately marked. See Figure 4-32.

#### **417. Taxiway shoulders.**

Unprotected soils adjacent to taxiways are susceptible to erosion, which can result in engine ingestion problems for jet engines that overhang the edge of the taxiway pavement. A dense, well-rooted turf cover can prevent erosion and support the occasional passage of aircraft, maintenance equipment, or emergency equipment under dry conditions. Soil with turf not suitable for this purpose requires a stabilized or low cost paved surface. Paved shoulders are required for taxiways, taxilanes and aprons accommodating ADG-IV and higher aircraft, and are recommended for taxiways, taxilanes and aprons accommodating ADG-III aircraft. Turf, aggregate-turf, soil cement, lime or bituminous stabilized soil are recommended adjacent to paved surfaces accommodating ADG-I and ADG-II aircraft.

**a. Shoulder dimensions.** Paved shoulders should run the full length of the taxiway(s). Table 4-2 presents taxiway shoulder width standards. Unusual local conditions may justify increases to these standard dimensions.



**Figure 4-32. Aligned taxiway**

**b. Pavement strength.** Shoulder pavement needs to support the occasional passage of the most demanding airplane as well as the heaviest existing or future emergency or maintenance vehicle for the design life of the full strength pavement. Standards are contained in AC 150/5370-10 and AC 150/5320-6.

**c. Drainage.** Surface drainage must be maintained in shoulder areas. See paragraph 418.b and Figure 4-33 for gradient standards. Where a paved shoulder abuts the taxiway, the joint should be flush. A 1.5 inch (38 mm) step is the standard at the edge of paved shoulders to enhance drainage and to prevent fine graded debris from accumulating on the pavement. Base and subbase courses must be of sufficient depth to maintain the drainage properties of granular base or subbase courses under the taxiway pavement. An alternative is to provide a subdrain system with sufficient manholes to permit observation and flushing of the system.

**d. Marking and lighting.** AC 150/5340-1 provides guidance for marking shoulders. New construction should provide for edge lights to be base mounted and for the installation of any cable under the shoulder to be in conduit. When adding shoulders to existing taxiways, the existing taxiway edge lighting circuitry, if not suitable, should be updated/modified prior to shoulder paving.

#### **418. Surface gradient and Line Of Sight (LOS).**

**a. LOS for intersecting taxiways.** There are no LOS requirements between intersecting taxiways. However, the sight distance along a runway from an intersecting taxiway needs to be sufficient to allow a taxiing aircraft to safely enter or cross the runway.

**b. Taxiways/taxilanes and TSAs.** The centerline longitudinal gradient and transverse gradient standards for taxiways/taxilanes and TSAs are as follows:

(1) The maximum longitudinal grade is 2.0 percent for Aircraft Approach Categories A and B and 1.50 percent for Aircraft Approach Categories C, D, and E. Minimum longitudinal grades are desirable.

(2) Avoid changes in longitudinal grades unless no other reasonable alternative is available. The maximum longitudinal grade change is 3.0 percent.

(3) When longitudinal grade changes are necessary, the vertical curves are parabolic. The minimum length of the vertical curve is 100 feet (30 m) for each 1.0 percent of change. A vertical curve is not necessary when the grade change is less than 0.40 percent, nor where a taxiway crosses a runway or taxiway crown. Where two taxiways intersect, flatter grades that provide adequate drainage are acceptable.

(4) The minimum distance between points of intersection of vertical curves is 100 feet (30 m) multiplied by the sum of the grade changes (in percent) associated with the two vertical curves.

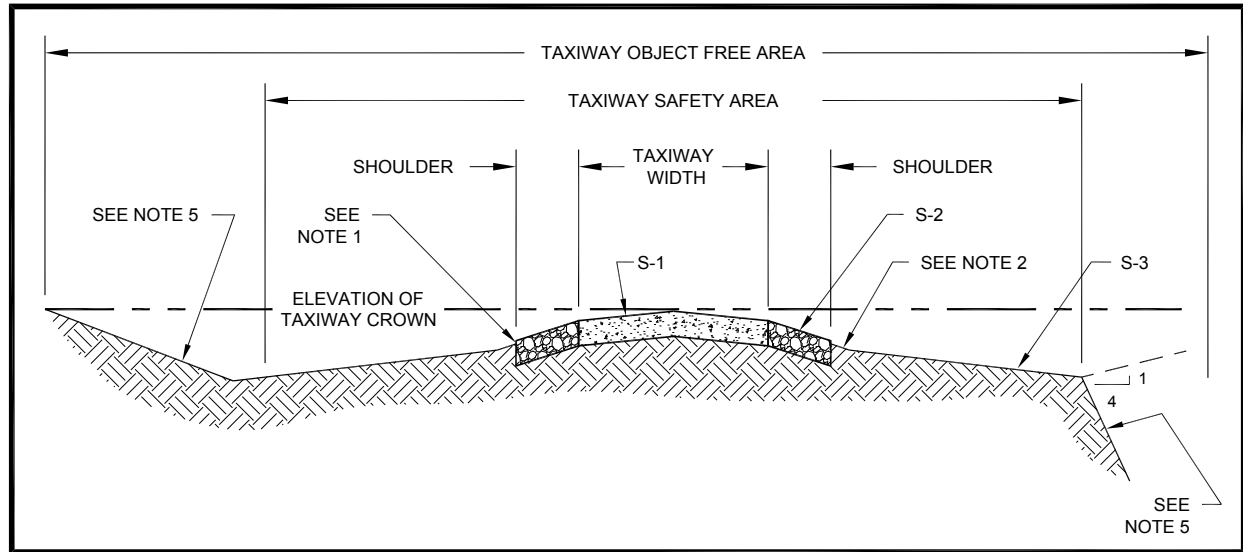
(5) When developing the longitudinal gradient of a parallel taxiway (or any taxiways functioning as parallel taxiways while not exactly parallel), the design of a parallel taxiway should consider potential future connecting taxiways. The longitudinal gradient of such connecting taxiways should be developed as necessary to confirm that taxiway design standards can be satisfied.

(6) Figure 4-33 and Table 3-3 present maximum and minimum transverse grades for taxiways. The crown of the taxiway should not be higher than the crown of the runway. Keep transverse grades to a minimum and consistent with local drainage requirements. The ideal configuration is a center crown with equal, constant transverse grades on either side. However, an off-center crown, different grades on either side, shed sections, and changes in transverse grade (other than from one side of the crown to the other) of no more than 0.5 percent are permissible. In particular, a shed section may be desirable on a high speed exit taxiway.

(7) Drainage improvements such as sharply sloped ditches or headwalls must not be located within the safety area. Ditch sections must meet longitudinal and transverse safety

area grading requirements and may not include channel linings such as riprap. Any inlets must be flush with grade and must meet safety area loadbearing requirements.

(8) Grading requirements for NAVAIDs located in the TSA are, in many cases, more stringent than those stated above. See Chapter 6.



**Notes:**

1. Construct a 1.5 inch (4 cm) drop between paved and unpaved surfaces.
2. Maintain a 5.0% grade for 10 feet of unpaved surface adjacent to the paved surface.
3. S-2 applies when shoulders are provided.
4. See Table 3-3 for S-1, S-2, and S-3.
5. The transverse slope from the edge of the TSA should be 0% or negative (unlimited) to the edge of the taxiway OFA if practicable. Allowable positive slope is 4:1.

**Figure 4-33. Taxiway transverse gradients**

**419. Markings/lighting/signs.**

Refer to AC 150/5340-1, AC 150/5340-30 and AC 150/5340-18.

**420. Islands.**

From the air, as well as on the pavement surface, large expanses of pavement can be confusing. Install well defined no-taxi islands between taxiways and between taxiways and runways to contribute to better situational awareness. Grass islands are preferred as they provide clear contrast with the pavement. If islands are paved they must be clearly marked as unusable pavement through the installation of artificial turf or by painting the island green and adding taxiway edge markings. Provisions must be made for the installation of lighting and vertical signs. See AC 150/5370-15.

**421. Taxiway bridges.**

Refer to Chapter 7 for detailed design guidance on bridges.



**422. Jet blast.**

Jet blast can cause erosion along taxiway shoulders. Special considerations are needed for shoulders, blast pads, and in some cases blast fences. See paragraph 417 for guidance on taxiway shoulders. Refer to Appendix 3 for information on the effects and treatment of jet blast.

**423. to 499. Reserved.**

**Page intentionally left blank.**

## Chapter 5. Aprons

### 501. Background.

This chapter presents design concepts related to aprons. An apron is typically located in the non-movement area of an airport near or adjacent to the terminal area. The function of an apron is to accommodate aircraft during loading and unloading of passengers and or cargo. Activities such as fueling, maintenance and short/long-term parking take place on an apron. Apron layout depends on aircraft gate positions; aircraft and ground vehicle circulation needs; and aircraft clearance requirements. A well laid-out apron minimizes runway incursions and effectively expedites aircraft services. Refer to [Appendix 5](#) for a more detailed discussion regarding general aviation aprons and hangars. [AC 150/5360-9](#) and [AC 150/5360-13](#) provide additional guidance for the planning and design of airport terminal facilities.

### 502. Apron types.

#### a. Terminal aprons.

(1) Passenger apron. This apron area is adjacent to the passenger terminal where passengers board and deplane from an aircraft. The apron must typically accommodate multiple activities such as fueling, maintenance, catering, loading/unloading baggage and cargo, aircraft servicing, boarding bridge maneuvering, passenger boarding/deplaning and aircraft docking/pushback. Airport designers are normally concerned about the practicality of the apron service movement areas and capacity, i.e., number and size of aircraft stands. Passenger terminal apron concepts must list the various aircraft stands to be considered by an airport engineer.

(2) Cargo apron. The cargo apron is dedicated to aircraft that carry only freight and mail. Such apron areas are typically near a cargo terminal building.

b. Remote apron. Some airports may require an area where aircraft can be secured and serviced for an extended period. Such aprons can be located remote from a terminal apron.

c. Hangar apron. This is an area on which aircraft move into and out of a storage hangar. The surface of such an apron is usually paved.

### 503. Apron layout and runway incursion prevention.

Apron locations that allow direct access onto a runway are not recommended. The apron layout should allow the design of taxiways in a manner that promotes good situational awareness by forcing pilots to consciously make turns ([Figure 4-3](#)). Taxiways originating from aprons and forming a straight line across runways are not recommended. Proper placement of aprons contributes to better accessibility, efficient aircraft movement and reduction in poor situational awareness conditions. Refer to [Chapter 4](#) for a detailed discussion on taxiway designs that are not recommended, as discussed below, such as:

a. Wide throat taxiway entrances from aprons are not recommended. Such large pavement expanses adjacent to an apron may cause confusion to pilots and loss of situational

awareness. Wide expanses of pavement also make it difficult to locate signs and lighting where they are easily visible to pilots.

**b.** Taxiway connectors that cross over a parallel taxiway from an apron and directly onto a runway are not recommended. Consider a staggered layout when taxiing from an apron onto a parallel taxiway and then onto a stub-taxiway or taxiway connector to a runway.

**c.** Direct connection from an apron to a parallel taxiway at the end of a runway is not recommended. Such geometry contributes to runway incursion incidents.

#### **504. Apron design.**

**a. General.** Aprons and associated taxilanes should be designed based on the design of aircraft and/or the combination of aircraft that will use the facility. Itinerant or transient aprons should be designed for easy access by the aircraft under power. Aprons designed to handle jet aircraft should take into account the effects of jet blast and allowing sufficient area for safe maneuvering. For commercial service airports, the aircraft positions at the terminal gates should be designed for the specific aircraft or range of aircraft. Cargo aprons are designed for specific aircraft with room provided for the loading and unloading of the cargo containers. Refer to [AC 150/5070-6](#), [AC 150/5360-9](#), [AC 150/5360-13](#), [ACRP Report 25](#), and the International Air Transport Association's (IATA's) Airport Development Reference Manual (ADRM) for additional guidance. Refer to [Appendix 5](#) for information on general aviation aprons.

**b. Design characteristics.** Each apron type requires the evaluation of several characteristics. Each apron typically serves a specialized purpose at an airport. Critical characteristics such as capacity, layout, efficiency, flexibility, safety and hangar locations should be considered.

**c. Capacity.** The amount of apron area varies from airport to airport depending on demand. The following guidelines help to determine the amount of apron space needed for each apron type:

**(1) Apron for Based Aircraft.** Refer to [Appendix 5](#). The apron for based aircraft may be in a different location than the apron for transient aircraft.

**(2) Apron Concepts for Passenger Terminals.** Proper planning helps determine the best applicable terminal passenger apron for a particular airport depending on whether there are pushback capabilities or aircraft have to power out. Reference [AC 150/5360-13](#) and [ACRP Report 25](#) for guidance. The following subparagraphs briefly discuss the various apron concepts:

**(a) Simple terminal:** A rectangular apron located adjacent to a terminal building. This type of apron is best suited for a low traffic volume airport. Aircraft may be parked nose towards or away from the terminal building.

(b) **Linear concept:** This an upgraded design from the simple concept. The apron can accommodate more passenger aircraft parked side by side with the aircraft nose configuration pointed towards the terminal building.

(c) **Pier concept:** Aircraft can be parked on both sides of the pier with multiple passenger gates. The pier concept allows more aircraft to be connected with the main terminal building.

(d) **Satellite concept:** Aprons are located remotely from the main terminal. Aircraft are typically parked around the entire building. Passenger access between the main terminal and satellite concourse(s) is typically via underground walkways or transporter surface vehicles. As such, the airport has in essence expanded the main terminal building into a satellite or multiple satellite terminal configurations.

(e) In addition, airport planners and designers may adopt a combination of several of the above concepts as airport passenger activities grow.

**d. Apron layout.** The primary design consideration is to provide adequate wingtip clearances for the aircraft positions and the associated taxilanes. Parked aircraft must remain clear of the Object Free Areas (OFAs) of runways and taxiways and no part of the parked aircraft should penetrate the runway approach and departure surfaces as described in paragraph 306 and, if applicable, the Runway Visibility Zone as shown in [Figure 3-7](#). Interactive [Table 3-5](#) gives the required setback from a runway to parked aircraft.

(1) **Design Considerations.** [Table 4-1](#) and paragraph 404 give the required OFA and wingtip clearance for a particular Airplane Design Group (ADG).

(2) **Terminal Design Considerations.** Aprons near terminals need to provide adequate room for the aircraft using the gates. Adequate area is also needed for all of the associated service vehicles and equipment including: passenger stairs, passenger buses, baggage carts, fuel trucks, food supply vehicles, and aircraft maintenance vehicles, and Aircraft Rescue and Fire Fighting (ARFF) vehicles. At low activity commercial service airports, passengers may walk from the terminal to the parked aircraft. In these cases it may be desirable to have defined walking paths with pavement marking or low barriers. See [AC 150/5360-13](#) and the respective aircraft manufacturers' Airplane Characteristics for Airport Planning documents for additional guidance.

**e. Efficiency.** Efficient apron design should address ease of aircraft maneuvering, limited taxi distance to and from the runways, and minimal ground vehicle movement to provide aircraft services. Other design considerations to address include:

(1) **Separating Different Sized Aircraft.** The layout of aprons and hangar complexes on an airport should be grouped according to the aircraft wingspans. This allows the taxilane OFA width to be optimized for the aircraft using the area. It is also good practice to separate corporate jets and heavy jets from lighter propeller powered aircraft to minimize the effects of jet blast.

(2) **Parking for Larger Aircraft.** Aircraft parking stands should be designed for the full range of aircraft anticipated in order to provide sufficient clearances so that aircraft using the position can do so under power. For transient areas the stands should also allow room for the aircraft to power out of the stall and still maintain adequate wingtip clearance. Some Fixed Base Operators (FBOs) may have small tugs available to move corporate jets and heavier aircraft around on the apron. For gates at terminal buildings or for cargo operations, the aircraft are usually pushed back from the gate or stand by tugs to a place on the taxiway or apron. Following the pushback they can ideally proceed under power, but they may need to be further tugged into position if jet blast is a potential problem. At commercial service airports a separate parking apron may be needed for aircraft to keep the gate positions available for scheduled flights; these are typically referred to as “Remain Over Night (RON)” aprons.

(3) **Flexibility.** Apron planners should evaluate several characteristics, such as the mix of aircraft types and sizes. Current and future use should be considered. Future expansion capability for the airport is important to an efficient apron design that allows for apron expansion without major construction or alteration to existing infrastructure or disruption to existing apron operations.

**f. Safety.** Safe maneuvering of aircraft on an apron is a result of the incorporation of several key design elements.

(1) **Clearances.** Apron design must at all times allow aircraft to maintain appropriate wingtip clearance during apron movement activities.

(2) **Services.** All services provided to apron parked aircraft, especially fueling, must be considered and allowances made for their activity and storage needs.

(3) **Pavement Gradient.** Apron pavements must be sloped away from buildings to prevent any fuel spills from spreading and endangering adjacent structures. Refer to paragraph 508.

(4) **Security.** Apron security is typically addressed as a part of terminal design to prevent access to aprons by unauthorized personnel. See Transportation Security Administration Information Publication A-001.

(5) **Passenger Boarding Activities.** Provide a clear delineation of passenger boarding areas/activities.

## **505. Fueling.**

Aircraft fueling is done on aprons in a variety of ways. Fuel trucks can come to the parked aircraft. For general aviation airports, aircraft can be fueled at pumps located at fueling islands or at stands along the edge of aprons. Underground fuel hydrants can be installed at gate parking positions; this is more frequently done when high volume fuel flowage is an issue. Refer to AC 150/5230-4 and NFPA 407.

**506. Object clearance.**

Wingtip and object clearance rules applying to taxiways and taxilanes also apply to taxiways and taxilanes on aprons. Table 4-1 gives the required Taxiway and Taxilane Object Free Area (TOFA) and wingtip clearance for a particular ADG. Refer to Table 4-1 and paragraph 404 for wingtip clearance guidance. See AC 150/5340-1 for guidance on the use of Non-Movement Area Boundary Markings.

**507. Deicing facilities.**

Refer to AC 150/5300-14.

**508. Surface gradients.**

The recommended surface gradients have been developed to ease aircraft towing and taxiing while promoting positive drainage. The maximum allowable grade in any direction is 2.0 percent for Aircraft Approach Categories A and B and 1.0 percent for Aircraft Approach Categories C, D, and E. The maximum grade change is 2.0 percent. There is no requirement for vertical curves, though on aprons designed for small propeller aircraft, special consideration should be made to reduce the chance of damaging low hanging propellers as the aircraft taxis through a swale at a catch basin. Near aircraft parking areas it is desirable to keep the slope closer to 1.0 percent to facilitate moving the aircraft into the stand. This flatter slope is also desirable for the pavement in front of hangar doors. Design apron grades to direct drainage away from any building, especially in fueling areas. Aircraft fueling aprons should slope away from all buildings at a minimum grade of 1.0 percent for the first 50 feet; then the apron slope to the drainage inlets can be reduced to a minimum slope of 0.5 percent. There should be a 1.5 inch (38 mm) drop-off at the pavement edge with the adjacent area sloped between 3.0 and 5.0 percent away from the pavement. Reference NFPA 415 and the IATA ADRM for additional guidance.

**509. Drainage.**

The drainage systems to handle the storm water runoff from an apron should be designed to handle the critical design storm events consistent with AC 150/5320-5 and local drainage requirements. Often, linear trench drains or slot drains are employed because they make it easier to design collection of runoff with the flatter slopes used on aprons. Since there can be fuel and oil spills on aprons, oil water separators and other appropriate treatment systems should be incorporated into the drainage systems. See NFPA 415 for additional information. Refer to AC 150/5200-33 for guidance on land uses that have the potential to attract hazardous wildlife on or near public-use airports.

**510. Marking and lighting.**

See AC 150/5340-1 for marking design information. Non-movement area marking is generally used between taxiways and aprons, as aprons are usually considered to be non-movement areas.

Area lighting of apron areas is desirable, especially at terminal gates. The area light beams must be directed downward and away from runway approaches and control towers. Shielding of the

lights may be needed to minimize unwanted glare. Area light spread should cover aircraft service areas. Refer to Illuminating Engineering Society of North America (IES), Recommended Practice for Airport Service Area Lighting, for additional guidance on apron area lighting.

The height of the floodlight poles must not exceed the runway approach and departure surfaces as described in paragraph 303. The height of floodlight poles must also be evaluated for Part 77 surface penetrations. An airspace determination is required prior to installation of poles for apron lighting.

#### **511. Pavement design.**

Apron pavements need to be designed to handle the aircraft planned to use the apron. Aprons are typically constructed of either asphalt concrete or portland cement concrete pavement. Apron pavement design considerations include the following: pavement useful life, surface damage resistance to fuel spills, pavement maintenance requirements, the effects of aircraft static load, and the effects of any aircraft support equipment including passenger boarding bridges and ARFF equipment. These are particularly important for apron pavement handling aircraft weighing over 100,000 lbs (45359 kg). See AC 150/5320-6 for pavement design.

#### **512. Jet blast.**

Some airports have engine run-up areas associated with the parking apron. For larger jet aircraft it may be advisable to erect blast fences to minimize the effect of the jet blast from run-up areas. Consideration should be made for the effects of jet blast as jet aircraft power up to move out of parking positions. See Appendix 3.

#### **513. Airport Traffic Control Tower (ATCT) visibility / Line Of Sight (LOS).**

It is essential for all aircraft movement areas on the airport to be visible to the controllers in the ATCT cab. Most apron areas are considered to be non-movement areas. Parking areas on aprons should be designed so the aircraft do not block the ATCT line of sight to the movement areas. At some larger commercial service airports there are separate airport or airline ramp control towers, and sophisticated ground radar tracking systems to monitor the aircraft movement on terminal aprons and on the airport. See Airport Surface Detection Equipment (ASDE) in paragraph 620. See Order 6480.4 for more information on the ATCT visibility requirements.

#### **514. Apron service roads.**

Designated service roads should be provided on aprons because they restrict service vehicle movements to a confined area(s) where the pilot is familiar with seeing vehicle activity. Proper layout of service roads on an airfield contributes to airport safety and the reduction in runway incursions. Factors to consider when designing service roads include items such as current/future vehicle and ground-service equipment movement, space, bearing strength, height clearance, separation standards from runways/taxiways, and access. The width of service roads depends on the projected traffic levels, widest equipment expected to use the service road, etc.

There are typically two locations for apron service roads: (1) behind the aircraft or (2) between the front of the aircraft stand and the terminal building. At commercial service and busy general



aviation airports, service roads may also run between the apron and the taxiway/taxilane for authorized vehicle access to parked aircraft. These roads should be clear of the OFAs for the runways and taxiways/taxilanes. Facilities should be designed to avoid service roads crossing runways and taxiways/taxilanes to the extent possible. However, when a crossing is necessary, proper marking must be in place to ensure vehicles stop or yield to aircraft. The service road should be defined with centerline and edge striping. See [AC 150/5340-1](#) for marking design information.

**515. to 599. Reserved.**

**Page intentionally left blank.**

## Chapter 6. Navigation Aids (NAVAIDs) and On-airport Air Traffic Control Facilities (ATC-F)

### 601. Background.

NAVAID systems are visual and instrument-based. Pilots are responsible for interpreting and using such systems without Air Traffic Control (ATC) assistance during landing operations. On-airport ATC facilities are used by air traffic personnel to assist pilots during takeoff and landing and safely guide aircraft within the terminal airspace, touch-down and surface movement on runways and taxiways.

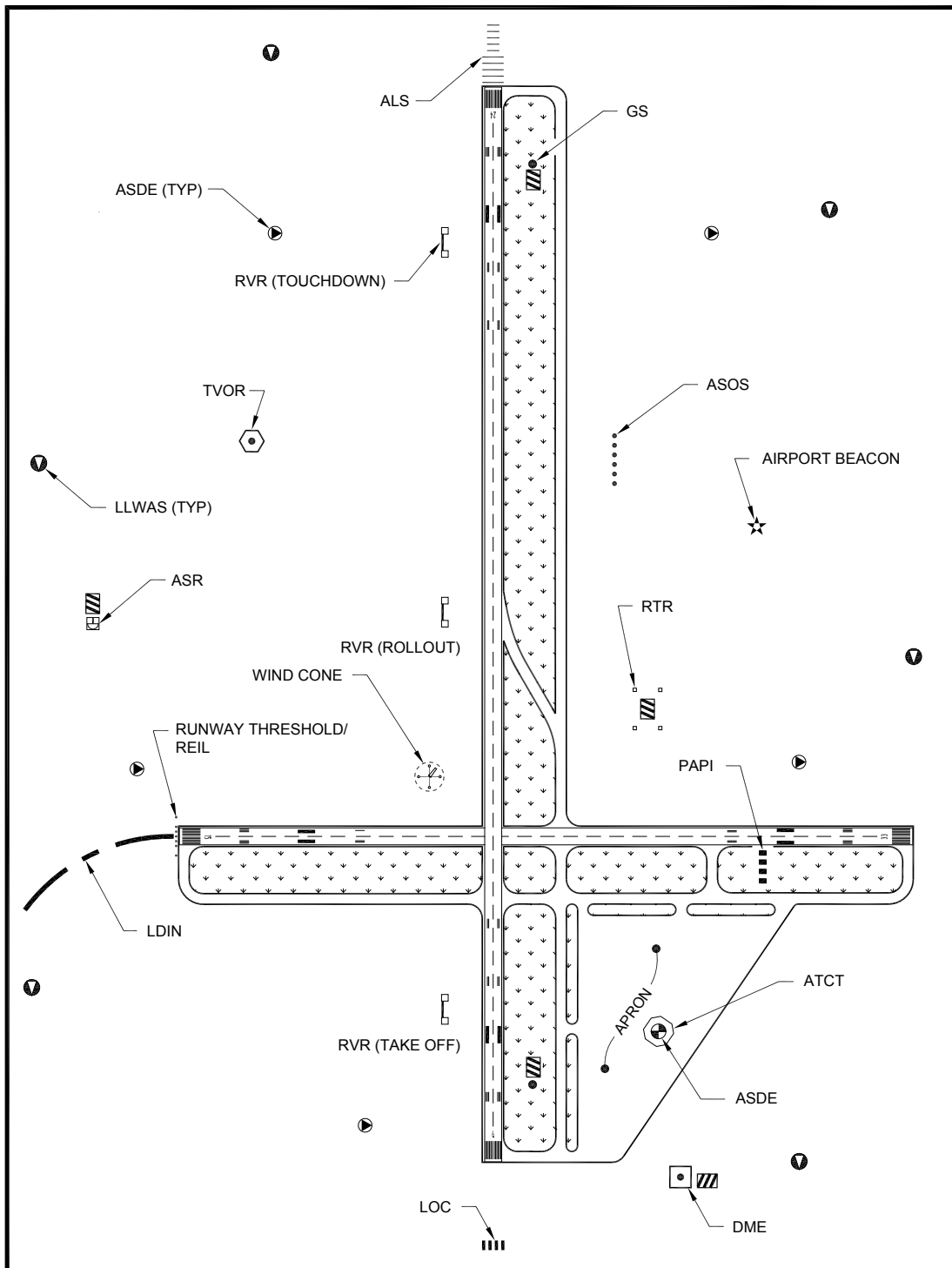
### 602. Introduction and purpose.

This chapter introduces, in general terms, Communications, Navigation, Surveillance and Weather (CNSW) facilities required for safe airport and air traffic operations. Use this information as general planning guidance to avoid conflicts between existing and/or planned airport facilities, including ATC facilities. The guidance below is not complete. The actual standards for siting requirements and establishment of ATC facilities are provided by FAA Orders and standards referenced within this chapter. In some cases, those siting standards may not be consistent with airport design standards in this AC. In such cases, coordinate with the appropriate FAA Airports office. Coordination with the appropriate FAA Air Traffic Organization (ATO) service center and technical operations field offices before finalizing plans for any airport expansion or CNSW installation is necessary to avoid conflicts and/or interruption to the National Airspace System (NAS) service. Figure 6-1 depicts the most commonly used systems and the general vicinity of these CNSW facilities on an airport.

**a.** CNSW use contributes to a greater number of air traffic operations during low-visibility and local weather awareness. CNSW facilities provide safety and increase capacity for airport operations. ATC facilities are useful during night-time and periods of poor visibility. For example, Approach Lighting System (ALS) enhance the visibility of the runway approach path. CNSW facilities are often expensive to establish and require additional space near runways and taxiways, including areas within the Building Restriction Line (BRL) to ensure airports operate at peak capacity. Cost to establish new and maintain existing CNSW facilities is the responsibility of the ATO within the FAA. In many cases, reimbursable projects are funded by airport authorities in support of ATC facility relocation. Airport expansion plans or projects may impact existing ATC facilities; hence, relocation projects are necessary. Under certain circumstances, Airport Improvement Program (AIP) funds may be eligible to support non-federal ATC-facility establishment and/or relocation.

**b.** CNSW facility types either serve a specific runway or the airport environment. For example, the Airport Surveillance Radar (ASR) is a rotating antenna sail located on a steel tower that allows aircraft to be detected by air traffic controllers within the terminal approach area during night operations or inclement weather conditions. An ALS helps pilots find and align with a specific runway for landing. NAVAIDs can be visual or electronic. Visual NAVAIDs consist of a light source that is perceived and interpreted by the pilot. Electronic NAVAIDs emit an electronic signal that either (1) is received by special equipment located on the aircraft, or (2) provides information about the location of the aircraft for ATC purposes.

Weather collection and reporting equipment is also included in this chapter as it is often installed on the airfield. Communication facilities are used by pilots and ATC to relay instructions for landing, taxiing and takeoff procedures.



**Figure 6-1. Typical Communications, Navigation, Surveillance and Weather (CNSW)**

**603. Federally owned and non-federally owned NAVAIDs.**

The FAA owns and maintains ATC equipment and instrument and visual NAVAID equipment. Costs associated with the modification or relocation of federally-owned NAVAIDs usually are not eligible for federal assistance. Information on eligibility for FAA-installed NAVAIDs and ATC facilities, or other FAA assistance programs, can be obtained from an FAA Airports Regional/Airports District Office. FAA policy governing NAVAID and ATC facility relocations is found in AC 150/5300-7. FAA policy concerning the establishment of non-Federal NAVAIDs is found in Part 171. Procedures for coordinating, planning, and installing these facilities are provided by Order JO 7400.2. At some airports there may be a combination of federally owned and non-federally owned NAVAIDs. Although it may be possible to have FAA assume maintenance responsibilities for non-Federal NAVAIDs, current policies, as given in Order 5100.38, generally prohibit FAA takeovers of airport installed NAVAIDs. Sometimes federally owned NAVAIDs are relocated to accommodate a change in the runway threshold or runway end as part of an AIP funded project. This work is covered by a reimbursable agreement between the airport and FAA ATO Engineering Services.

**604. Siting criteria/land requirements.**

**a. Siting criteria/land requirements.** For each NAVAID and ATC facility there are specific criteria that must be met to allow the device to function properly. These are further described in the paragraphs for each NAVAID system. The optimum location of the device relative to the runway/taxiway or airport varies by the function of the device. There are tolerances to the ideal device siting location, which allow some flexibility to fit existing facilities. See also AC 150/5300-18 for NAVAIDs characteristics.

**b. Separation/clearance.** In addition to the location of the NAVAID and the land needed, there are specific separation and clearance standards for each device for it to function properly. Each device has allowable height and separation distances for above-ground objects around the device so that the electronic or light signal is not impacted. The size, shape, mass and material nature of the object can impact the function of a device that transmits an electronic signal. For communications and surveillance antennas, including some NAVAID antennas, there is a critical area immediately around the device that must be kept clear of all above-ground objects. Once a NAVAID is installed, it is important for the airport operator to maintain the separation and clearance standards as future construction is considered. A Notice of Proposed Construction or Alteration (FAA Form 7460-1) must be submitted to the FAA to allow an evaluation of the potential impact of any proposed construction in the vicinity of a NAVAID. Sometimes the nature of construction activity will by itself mean that the NAVAID must be temporarily turned off, to prevent a false signal from being transmitted. Reference AC 150/5370-2.

**c. Critical areas.** Many NAVAIDs and ATC facilities have a defined critical area that must be protected to ensure adequate performance.

**(1) Geometry.** Each critical area extends a certain distance out in every direction. It can be circular or rectangular in shape. The dimensions may vary based on the

aircraft and terminal operations the NAVAID and ATC facility is designed to serve respectively and the precision of the device in use.

(2) **Grading.** There are standards for grading the ground around each of the NAVAIDs. In general, the immediate area around the device should be relatively smooth, level and well drained.

(3) **Protection.** Maintenance activities such as mowing or the use of service vehicles within the critical area should be coordinated with the tower and local FAA technical operations offices to prevent a degradation of the function of the NAVAID during Instrument Flight Rules (IFR) conditions when the operation of the NAVAID is critical. Proposed construction in the vicinity of any NAVAID must be reviewed and analyzed as mentioned in paragraph 603 to determine any potential impacts to the function of the NAVAID. For off-airport NAVAIDs, installation of fencing or guardrails along the perimeter of the critical area is needed to keep these areas clear. For certain systems, due to false reflective targets or poor accuracy, care should be exercised when a decision to fence around a critical area is made.

d. **Jet blast/exhaust.** NAVAIDs, monitoring devices, and equipment shelters should be located at least 600 feet (183 m) behind the source of jet blast to minimize the accumulation of exhaust deposits on antennas.

#### **605. NAVAIDs as obstacles.**

Any object, including NAVAIDs, that are located near an active runway can present an increased risk to aircraft operations. In particular, FAA standards for Runway Safety Areas (RSAs) and Runway Object Free Areas (ROFAs) recognize the need to limit NAVAIDs except those required to be in a certain location to perform their function. These NAVAIDs are fixed-by-function in regard to the RSA or ROFA. Any NAVAID object that remains inside the RSA, whether fixed-by-function NAVAIDs or not, must be supported by frangible structures that minimize damage to any aircraft that might strike the object.

a. **Fixed-by-function.** While it is desirable not to have any objects in areas that could be a hazard to aircraft, some NAVAIDs have been classified as being fixed-by-function. In other words, the NAVAID location is critical for its proper functioning and the safety benefit derived from the operation of the NAVAID outweighs the potential risk of an aircraft striking the NAVAID. A fixed-by-function determination allows NAVAIDs to be in the RSAs or Object Free Areas (OFAs). However, the power and control equipment and shelters associated with certain NAVAIDs are not considered to be fixed-by-function in regard to the RSA or OFA, unless operational requirements require them to be near the NAVAID. See fixed-by-function definition, paragraph 102. Table 6-1 gives fixed-by-function designations for various NAVAIDs in regard to the RSA or ROFA.

**Table 6-1. Fixed-by-function designation for NAVAID and Air Traffic Control (ATC) facilities for Runway Safety Area (RSA) and Runway Object Free Area (ROFA)**

NAVAID	Fixed-By-Function		
	In RSA	In ROFA	Associated Equipment
Airport Beacon	No	No	N/A
ALS	Yes	Yes	No <sup>1</sup>
ASDE-X	No	No	N/A
ASOS, AWOS	No	No	N/A
ASR	No	No	N/A
ATCT	No	No	N/A
DME	No	No	No
GS	No <sup>2</sup>	No <sup>2,3</sup>	No
IM	Yes	Yes	Yes
LDIN	Yes	Yes	No <sup>1</sup>
LOC	No	No	No
LLWAS	No	No	No
MM	No	No	No
NDB	No	No	N/A
OM	No	No	No
PRM	No	No	No
REIL	Yes	Yes	No <sup>1</sup>
Runway Lights and Signs	Yes	Yes	No
RTR	No	No	No
RVR	No	Yes	Yes
RWSL	Yes	Yes	No
Taxiway Lights and Signs	Yes	Yes	No
VOR/TACAN/VORTAC	No	No	N/A
PAPI & VASI	Yes	Yes	No
WAAS	No	No	No
WCAM	No	No	No
WEF	No	No	No
Wind Cone	No	No	No

**Notes:**

1. Flasher light power units (Individual Control Cabinets) are fixed-by-function.
2. End Fire glideslopes are fixed-by-function in the RSA/ROFA.
3. Allowing a GS within ROFA due to a physical constraint should be evaluated on a case-by-case basis.

**b. Frangibility.** NAVAID objects located within operational areas on the airport are generally mounted with frangible couplings, with the point of frangibility no higher than 3 inches (76 mm) above the ground on the mounting legs, which are designed to break away upon impact.

This reduces the potential damage to an aircraft that inadvertently leaves the paved surfaces. This requirement is the standard for RSAs, whether the NAVAID is fixed-by-function or not. [AC 150/5220-23](#) provides guidance on frangible connections to meet frangibility requirements.



**Figure 6-2. Two frangible connections**

**c. Non-standard installations.** Any NAVAID or associated equipment that remains inside the RSA and is not fixed-by-function or does not meet frangibility requirements is a non-standard installation. The FAA will require that the NAVAID be removed from the RSA if practicable.

**d. Marking and lighting.** NAVAIDs that penetrate the [Part 77](#) surfaces are marked with international orange and white paint and lights, with red obstruction lights placed on the highest point. This makes the NAVAID and other ATC-F more visible to the pilot. Refer to [AC 70/7460-1](#).

#### **606. Physical security.**

Airport facilities require protection from acts of vandalism. To provide a measure of protection, unauthorized persons must be precluded from having access to NAVAIDs and ATC facilities. Perimeter fencing could be installed to preclude inadvertent entry of people or animals onto the airport. In addition to airport perimeter fencing, the following security measures are recommended:

**a. Off-airport facilities.** Navigational and ATC-F located off an airport and in a location that is accessible to animals or the public will have a security perimeter fence installed at the time of construction. [Figure 6-36](#) shows an example of security perimeter fence installed around an off-airport weather detection facility/sensor.

**b. On-airport facilities.** Navigational and ATC-F located on the airport have at least the protection of the operational areas. Any protection device, e.g., a guard rail or security



fence, that penetrates a Part 77 surface is an obstruction to air navigation. As such, it is presumed to be a hazard to air navigation until an FAA study determines otherwise. Table 6-2, Table 6-3, Table 6-4, and Table 6-5 capture on-airport and off-airport facility types.

**Table 6-2. List of NAVAID facility type**

<b>Acronym</b>	<b>Facility Type</b>	<b>On-Airport</b>	<b>Off-Airport</b>
ALS	Approach Lighting System	X	X
ABN	Airport Beacon	X	
DF	Direction Finder – UHF/VHF		X
DME	Distance Measuring Equipment	X	
DMER	Distance Measuring Equipment Remaining		X
ETB	Embedded Threshold Bar	X	
FM	Fan Marker		X
GDL	Guidance Light Facility	X	X
GS	Glideslope	X	
IM	Inner Marker	X	X
LDIN	Lead-in Lighting System	X	X
LMM	Compass Locator at the ILS Middle Marker (MM)	X	X
LOC	Localizer	X	
LOM	Compass Locator at the ILS Outer Marker		X
MALS	Medium Intensity Approach Lighting System	X	X
MALSF	Medium Intensity ALS with Sequenced Flashing Lights	X	X
MALSR	Medium Intensity ALS with Runway Alignment	X	X
MM	Middle Marker	X	X
NDB	Non-directional Beacon	X	X
ODALS	Omnidirectional Airport Lighting System	X	X
OM	Outer Marker		X
PAPI	Precision Approach Path Indicator	X	
REIL	Runway End Identifier Lights	X	
RVR	Runway Visual Range	X	
SSALR	Simplified Short Approach Light System with Runway Alignment	X	X
SSALS	Simplified Short Approach Light System	X	X
TACAN	Tactical Air Navigation	X	X
TVOR	Terminal VHF Omnidirectional Range	X	
VASI	Visual Approach Slope Indicator	X	
VOR	VHF Omnidirectional Range	X	X
VORTAC	Combined VOR & TACAN	X	X
VOT	VHF Omnidirectional Range Test	X	X
WRS	WAAS Reference System	X	X
	Runway and Taxiway Lighting	X	
	Runway and Taxiway Signs	X	

**Table 6-3. Surveillance facility type**

<b>Acronym</b>	<b>Facility Type</b>	<b>On-Airport</b>	<b>Off-Airport</b>
ARSR	Air Route Surveillance Radar		X
ASDE	Airport Surface Detection System	X	
ASR	Airport Surveillance Radar	X	
ATCBI	Air Traffic Control Beacon Interrogator		X
ATCRB	Air Traffic Control Radar Beacon	X	
MODES	Mode Select Beacon System	X	
PRM	Precision Runway Monitor	X	
RBPM	Remote Beacon Performance Monitor		X
RMLR	Radar Microwave Link Repeater		X
RMLT	Radar Microwave Link Terminal		X

**Table 6-4. Communications facility type**

<b>Acronym</b>	<b>Facility Type</b>	<b>On-Airport</b>	<b>Off-Airport</b>
BUEC	Backup Emergency Communication System		X
ECS	Emergency Communication System		X
GBT	Ground Based Transceiver		X
IFST	International Flight Service Transmitter		X
RCAG	Remote Communication Air to Ground		X
RCLR	Radio Communications Link Repeater		X
RCLT	Radio Communications Link Terminal		X
RCO	Remote Communications Outlet	X	X
RTR	Remote Transmitter/Receiver	X	
SACOM	Satellite Communications Network		X
SSO	Self-Sustained Outlet		X
TMLR	Television Microwave Link Repeater		X

**Table 6-5. Weather detection facility type**

<b>Acronym</b>	<b>Facility Type</b>	<b>On-Airport</b>	<b>Off-Airport</b>
ASOS	Automated Surface Observing System	X	
AWOS	Automated Weather Observing System	X	
AWSS	Automated Weather Sensor System	X	
LLWAS	Low Level Windshear Alert System	X	X
NXRAD	Next Generation Weather Radar		X
OAW	Off Airways Weather Station		X
RRH	Remote Readout Hygrothermometers	X	X
SAWS	Stand Alone Weather Sensors	X	
TDWR	Terminal Doppler Weather Radar		X
WCAM	Weather Camera	X	X
WEF	Wind Equipment F-400 Series	X	
WME	Wind Measuring Equipment	X	

**607. Maintenance access.**

NAVAID facilities need periodic maintenance for proper operation and require vehicular access roads to equipment shelters, as well as antenna arrays and light stations. The location of access roads must be chosen carefully to ensure that they do not penetrate airport design surfaces or violate other design criteria such as RSAs. Maintenance access roads are fixed-by-function when they serve a fixed-by-function NAVAID, but the route should be direct to minimize exposure to RSAs and OFAs. To prevent vehicle tires from tracking Foreign Object Debris (FOD) onto runways and taxiways, the first 300 feet (91 m) adjacent to a paved operational surface should be paved.

**608. Electrical power.**

The FAA recognizes the need to have a reliable power source to operate NAVAIDs, even during utility power outages. Order 6030.20 establishes Continuous Power Airports (CPAs) that provide continuous operations in the event of an area-wide utility failure. Backup power to designated runways at these airports must be able to supply power for at least 4 hours for runway lighting as well as navigation, landing and communication equipment. In addition, FAA policy also requires that power systems used for support of Category (CAT) II and CAT-III operations must be capable of transferring to an alternate source within one second. Information on FAA funding for electrical power systems can be found in Order 5100.38.

**609. Cable protection.**

Most NAVAID and ATC-F discussed in this chapter are served by buried power, data and control cables. FAA cables are typically buried approximately 24 inches (610 mm) below ground. They should be installed in conduit or duct beneath runways, taxiways, and roadways; and in duct banks and manhole systems under aprons and paved parking areas. Information regarding the location of FAA cables and ducts may be obtained from the FAA ATO Service Center Engineering office.

**610. Cable loop system.**

For the benefit of redundancy and uninterrupted service, ATO established a cable loop system at certain airports. Order 6950.23 addresses control/monitor, digital data, voice/voice frequency and radar video/trigger signals. Airport designers should be aware of the presence of cable loop systems as they are developing airport plans and infrastructure.

**611. Communication and power cable trenches.**

The FAA has specific guidelines on the placement of underground communication and power cables in trenches. Airport engineers should be aware of such details as they are designing airport facilities, developing airport plans and right-of-ways for cable and power trenches. Contact the appropriate FAA Technical Operations office for details.

**612. Facilities.**

**a. General.** The design and construction of the infrastructure that houses electrical/electronic components of NAVAIDs, surveillance, weather and communication systems are closely controlled by strict design guidelines via standards and orders. These orders are the responsibility of the ATO. Interior electrical distribution, electrical panels, grounding, bonding, lightning protection, power distribution, cable trays, heating, cooling and ventilation systems, above-ground fuel tanks, engine generators, access roads, security fences, gates, etc., all must be designed according to the latest FAA standards and orders.

**b. Building material.** The square footage and on-airport location of the facility does dictate the type of material used. Glideslope (GS), DME and localizer (LOC) shelters are constructed from fiberglass. Masonry structures usually house radar and communication equipment. More rigid structures are located within the BRL. Radar and communication facilities do require more square footage due to the footprint requirement of the electronics and environmental support equipment.

**c. References.**

- (1) Specification FAA-C-1217, Electrical Work, Interior
- (2) Specification FAA-C-1391, Installation and Splicing of UndergroundCables
- (3) Standard FAA-STD-019, Lightning and Surge Protection, Grounding, Bonding and Shielding Requirements for Facilities and Electronics Equipment
- (4) Order JO 6580.3, Remote Communications Facilities Installation Standards Handbook

**613. Towers and elevated structures.**

Radar, approach light support and communication antennas require special elevated structures. ATO has developed standard designs for galvanized structural steel towers. Special design consideration should take into account accessibility, maintenance, weather conditions, soil conditions and terrain. “As-built” and standard facility drawings can be accessible via the appropriate ATO service center and/or field support office.

**614. Air Traffic Organization (ATO) – Orders and Notices.**

FAA Orders related to infrastructure establishment and sustainment (some components are listed in paragraph 612) can be found on the FAA website, under the ATO “Orders & Notices” link [http://www.faa.gov/regulations\\_policies/orders\\_notices/](http://www.faa.gov/regulations_policies/orders_notices/).

**615. Decommissioned facilities.**

With the on-going Global Positioning System (GPS) gradual implementation and use in the NAS, certain ground based NAVAIDs facilities are slowly being removed from service. Airport

designers should coordinate with FAA local, regional and service area airspace and flight procedures organizations to identify NAVAID commissioning and decommissioning planned to occur in the area/airport of interest.

#### **616. Airport Traffic Control Tower (ATCT).**

ATCT is a staffed facility that uses air/ground communications and other ATC systems to provide air traffic services on, and in the vicinity of, an airport. The ATCT must be located near active runways to give controllers adequate visibility of the surface movement area, takeoff and landing areas. Order 6480.4 is a good document to consult. Generally the tower must be located at a minimum height that meets visibility performance requirements for all controlled movement areas. FAA normally requires use of the Airport Facilities Terminal Integration Laboratory (AFTIL) for all new and proposed replacements of ATCT. This includes FAA Contract Towers, non-Federal Towers using FAA funds, and those built by FAA directly. The AFTIL uses a three-dimensional computerized terrain model of the airport for real time simulations of actual and proposed working environment.



**Figure 6-3. Airport Traffic Control Tower (ATCT) facility**

### 617. Remote Transmitter/Receiver (RTR) and Remote Communications Outlet (RCO).

RTR and RCO are air-to-ground communications systems having transmitters and/or receivers and other ancillary equipment serving a terminal facility. These on-airport facilities allow radio communications between the pilot and ATCT. Line-of-sight between communications towers, aircraft and ATCT is critical. An RCO is usually located at non-towered airports, and in some cases is located off airport. Communication facilities are usually within the BRL. There is no current order to site these facilities, but some information is contained in [Order JO 6580.3](#).



**Figure 6-4. Remote Transmitter/Receiver (RTR) communication facility**

### 618. Airport Surveillance Radar (ASR).

ASR is a radar facility used to detect and display azimuth, range, and elevation of aircraft operating within terminal airspace. ASR antennas scan through 360 degrees to present the controller with the location of all aircraft within 60 nautical miles of the airport. The access to power and communication duct banks to and from the ATCT is an important factor to consider in selecting a location for an ASR facility. The primary factor in determining the best operational location is based on the latest ASR model siting selection criteria. [Order 6310.6](#) discusses the siting criteria.

**a. Location.** The ASR antenna and equipment building should be located as close to the ATCT as practical and economically feasible.

**b. Clearances.** Antennas should be located at least 1,500 feet (457 m) from any building or object that might cause signal reflections and at least one-half mile (0.8 km) from other electronic equipment. ASR antennas may be elevated to obtain line-of-sight clearance. Typical ASRs (antenna platform heights – mezzanine level) ranges from 17 to 77 feet (5 to

23.5 m) above ground level (AGL). The antenna tower is a standard 24 feet × 24 feet (7 m × 7 m) galvanized steel structure. Additional ten-foot (3 m) sections are usually added incrementally until the radar platform gains the desired elevation. Trees and other structures should stay below the mezzanine level at all times. The presence of wind turbines in the vicinity of an airport should be carefully evaluated while siting the location of a radar antenna system as such objects do cause reflectivity issues and are the cause of false targets.



**Figure 6-5. Airport Surveillance Radar (ASR) steel tower (17 feet [5 m] high)**

#### **619. Precision Runway Monitor (PRM).**

PRM is an electronically scanned secondary radar that monitors simultaneous close parallel instrument approaches to airports. This system enables air traffic controllers to monitor aircraft approaches to parallel runways spaced less than 4,300 feet (1311 m) apart. There are no FAA Orders to reference a siting criteria for PRM facilities. The general location of a PRM is adjacent to one of the parallel runways.



**Figure 6-6. Precision Runway Monitor (PRM) facility**

#### **620. Airport Surface Detection Equipment (ASDE).**

ASDE compensates for the loss of line-of-sight to some surface traffic being observed by ATC and during periods of reduced visibility. The detection equipment is specifically designed to cover all principal features on the surface of an airport, including aircraft and vehicular traffic. The ASDE system consists of several transmitters and receivers located near runways and taxiways, including roofs of terminal buildings and hangars. ASDE equipment should be sited to provide continuous line-of-sight coverage between the aircraft-equipped surface vehicles, sensors and radar. A multi-lateration process is constantly triangulating the line-of-sight signals between the aircraft and at least three sensors. While the ideal location for the ASDE antenna/radar is on the ATCT cab roof, a standalone antenna may be placed on a free-standing tower up to 100 feet (30 m) tall located within 6,000 feet (1829 m) of the ATCT cab. There is no current guidance for ASDE installations on airports. See [AC 150/5220-26](#).

#### **621. Approach Lighting System (ALS).**

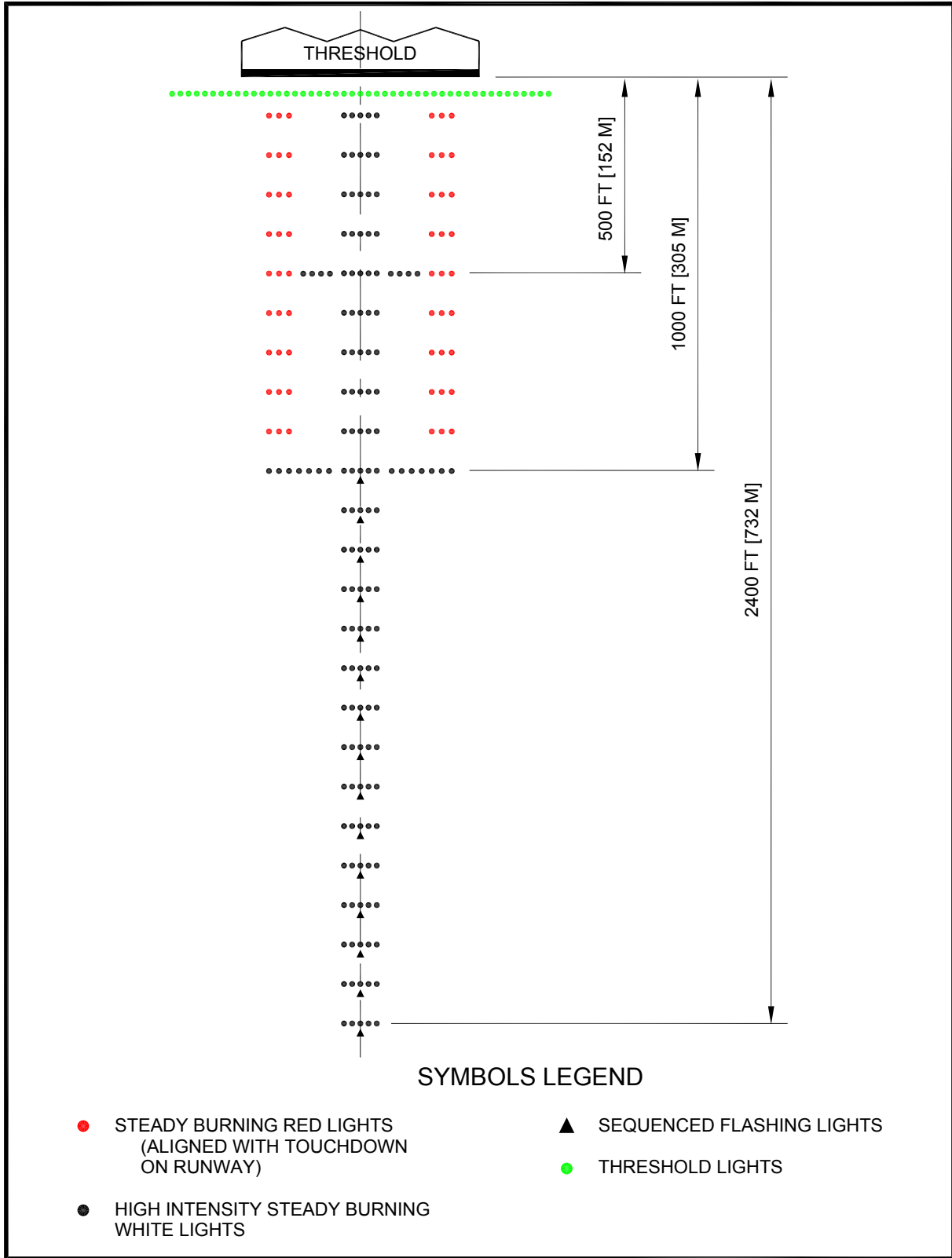
All ALSs are configurations of lights positioned symmetrically along the extended runway centerline. They begin at the runway threshold and extend towards the approach. The approach lighting is usually controlled by the ATCT, but may be controlled by the airport operator, or by a pilot via very high frequency (VHF) radio. An ALS often supplements electronic NAVAID, resulting in lower visibility minimums. All ALSs in the United States use a feature called the Decision Bar. The Decision Bar is always located 1,000 feet (305 m) from the threshold, and it serves as a visible horizon to ease the transition from instrument flight to visual flight. Guidance on ALSs is found in [Order JO 6850.2](#).

**a. ALS configurations.** The FAA uses many ALS configurations to meet visual requirements for precision and non-precision approaches (NPAs). See [Figure 6-7](#), [Figure 6-8](#), [Figure 6-9](#), [Figure 6-11](#), [Figure 6-12](#), and [Figure 6-13](#).



(1) An ALS with Sequenced Flashing Lights (ALSF) with Sequenced Flashers I (ALSF-1) or an ALS with Sequenced Flashers II (ALSF-2) is a 2,400-foot (730 m) high intensity ALS with lights stations positioned every 100 feet (30 m). These systems also include sequenced flashing lights. They are required for CAT-II and CAT-III precision approaches. A civil ALSF-2 may be operated as a Simplified Short Approach Light System with Runway Alignment (SSALR) during favorable weather conditions. See [Figure 6-7](#) and [Figure 6-8](#).

(2) A Medium Intensity ALS with Runway Alignment (MALSR) is a 2,400-foot (732 m) medium intensity ALS with light stations position every 200 feet (61 m). This system includes sequenced flashing runway alignment indicator lights (RAILs). It is an economy ALS approved for CAT-I precision approaches. A SSALR system has the same configuration as a MALSR, but uses high intensity lights. See [Figure 6-9](#).



**Figure 6-7. Approach Lighting System (ALS) with Sequenced Flashers II (ALSF-2)**

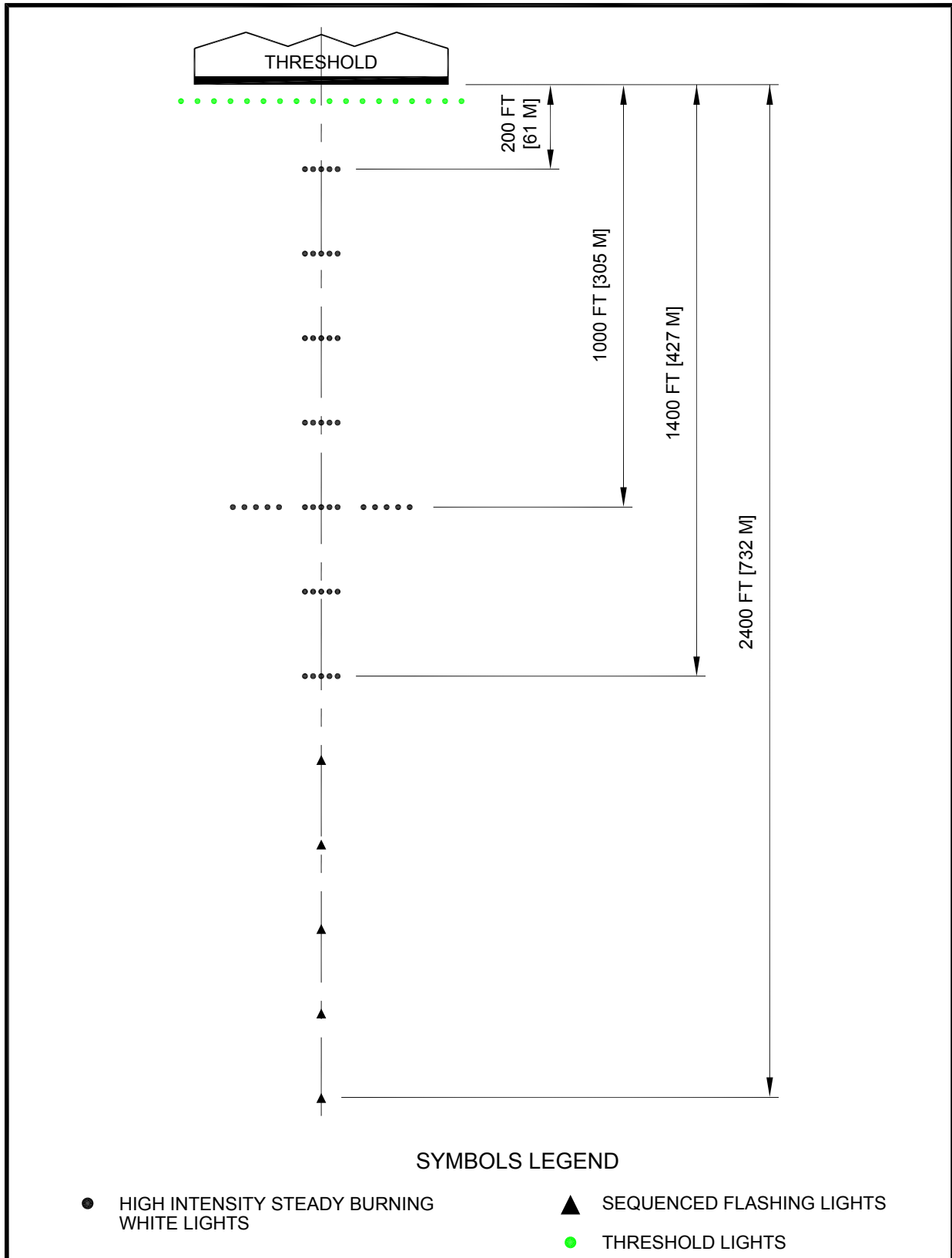
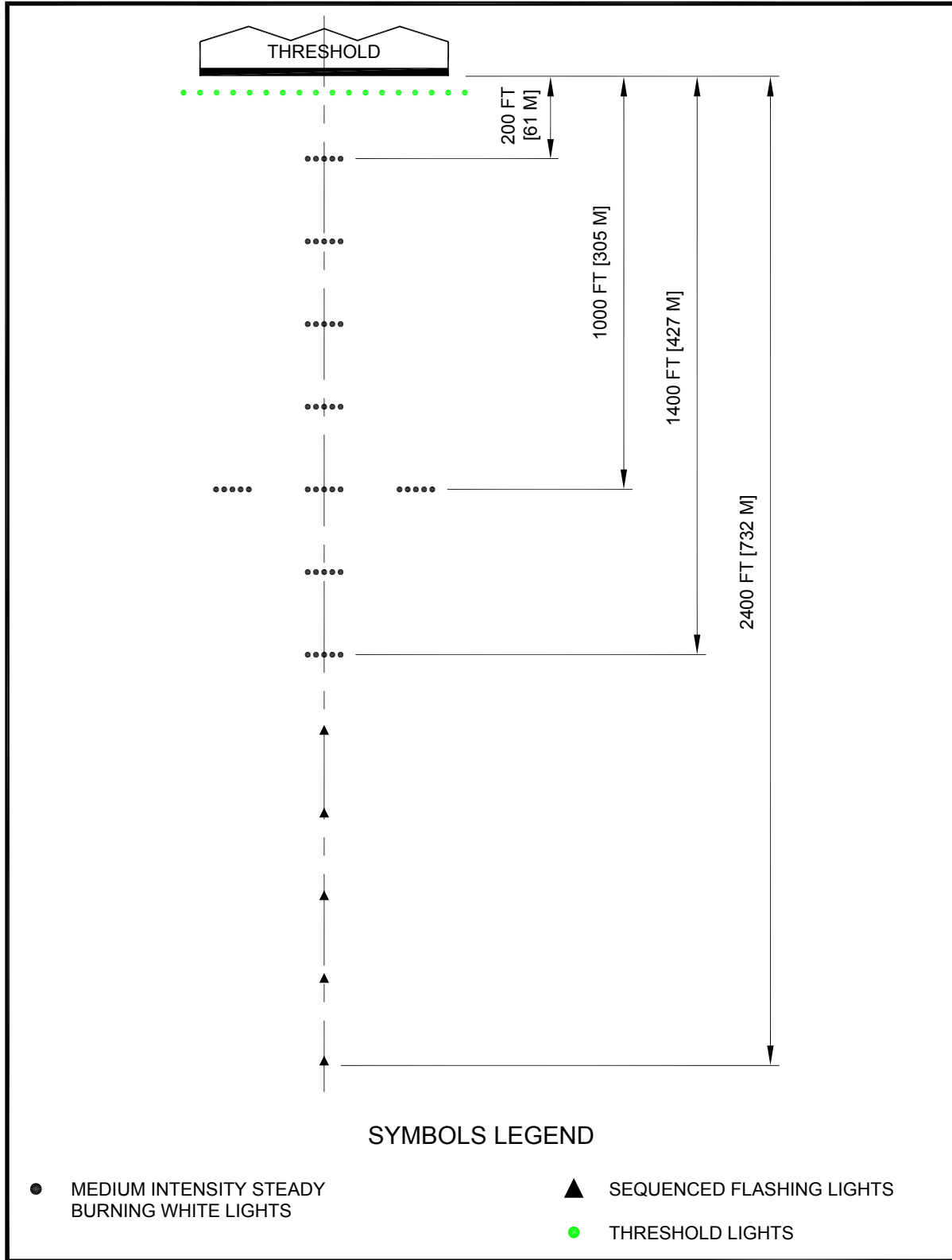


Figure 6-8. Simplified Short Approach Light System with Runway Alignment (SSALR)

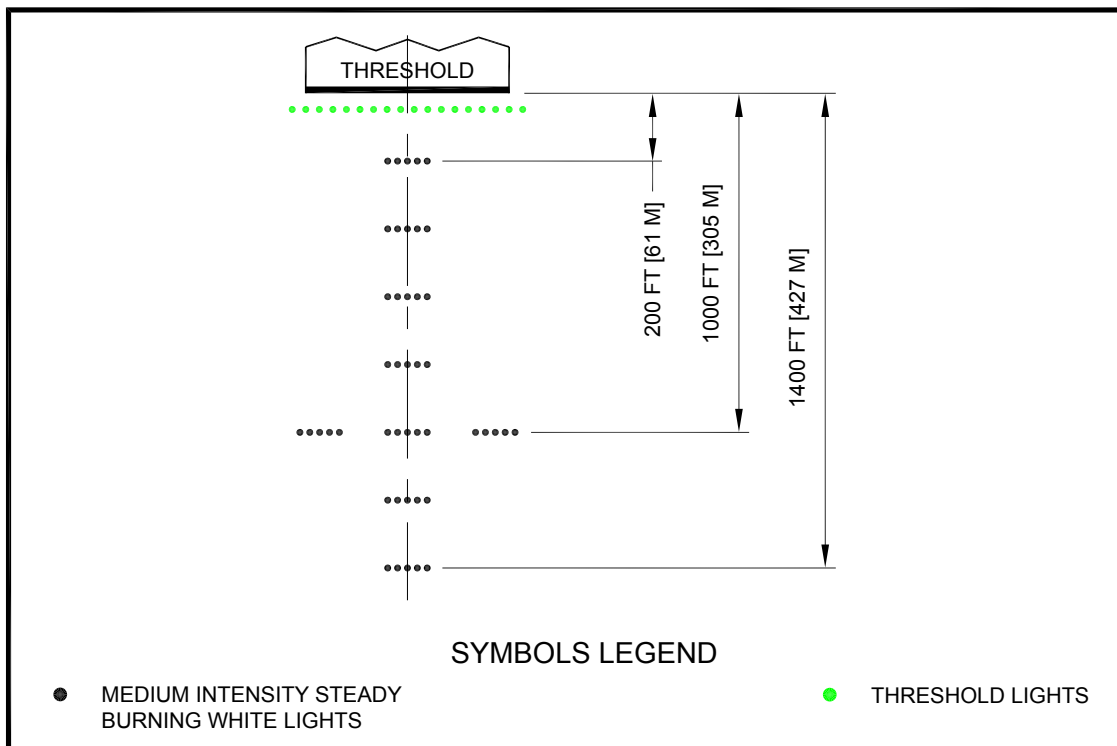


**Figure 6-9. Medium Intensity Approach Lighting System (MALSR) with Runway Alignment Indicator Lights (MALSR)**

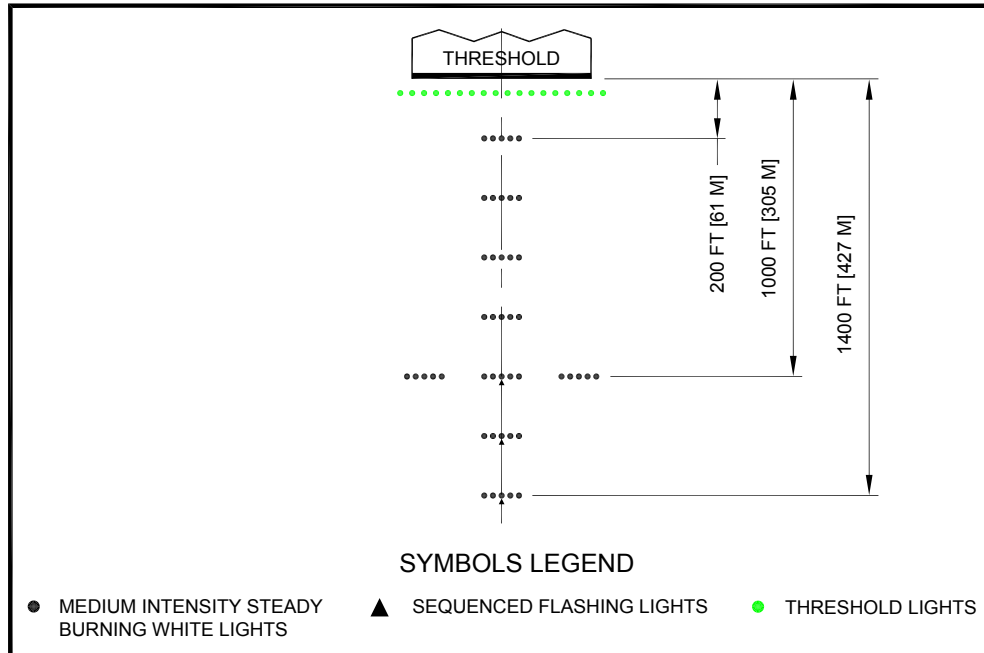


**Figure 6-10. MALS facility**

(3) A Medium Intensity Approach Lighting System (MALS) or Medium Intensity ALS with Sequenced Flashing Lights (MALSF) is a 1,400-foot (427 m) medium intensity ALS with light stations positioned every 200 feet (61 m). It enhances non-precision instrument and night visual approaches. The MALSF includes sequenced flashing lights on the outer three light stations. Simplified Short Approach Light System (SSALS) and Simplified Short Approach Light System with Sequenced Flashing Lights (SSALF) have the same configuration as a MALS and MALSF respectively, but use high intensity lights instead of medium intensity. See [Figure 6-11](#) and [Figure 6-12](#). Additional information and guidance can be found in [AC 150/5340-30](#).

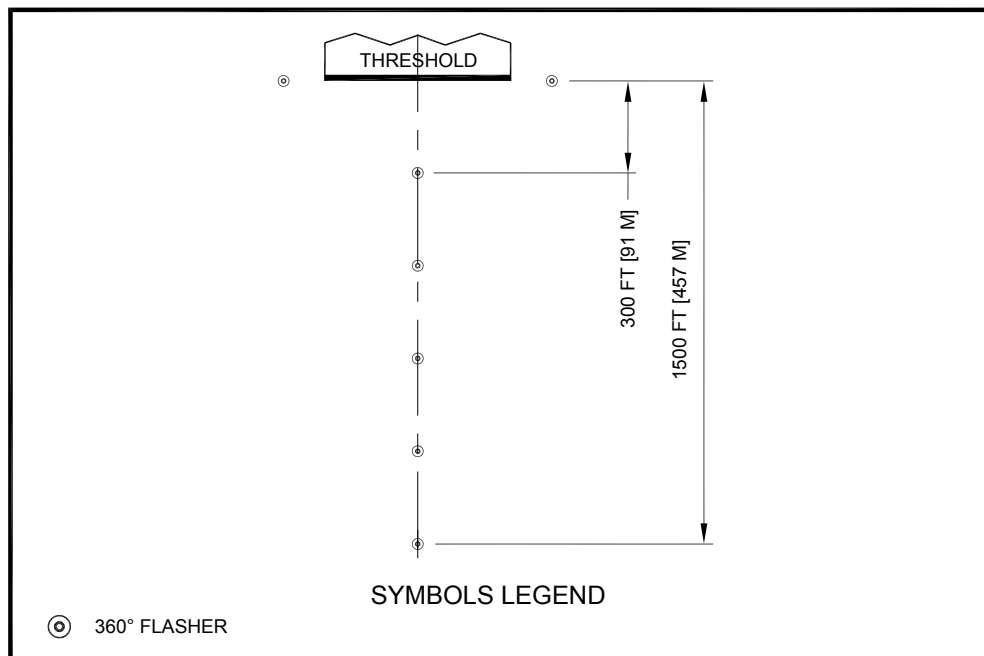


**Figure 6-11. MALS**



**Figure 6-12. MALS with Sequenced Flashers (MALSF)**

(4) An Omnidirectional Approach Lighting System (ODALS) consists of seven (7) 360 degree flashing light stations that extend up to 1,500 feet (457 m) from the runway threshold. Two of the lights are positioned on either side of the runway threshold and effectively function as Runway End Identifier Lighting (REIL). See [Figure 6-13](#). Additional information and guidance can be found in [AC 150/5340-30](#).



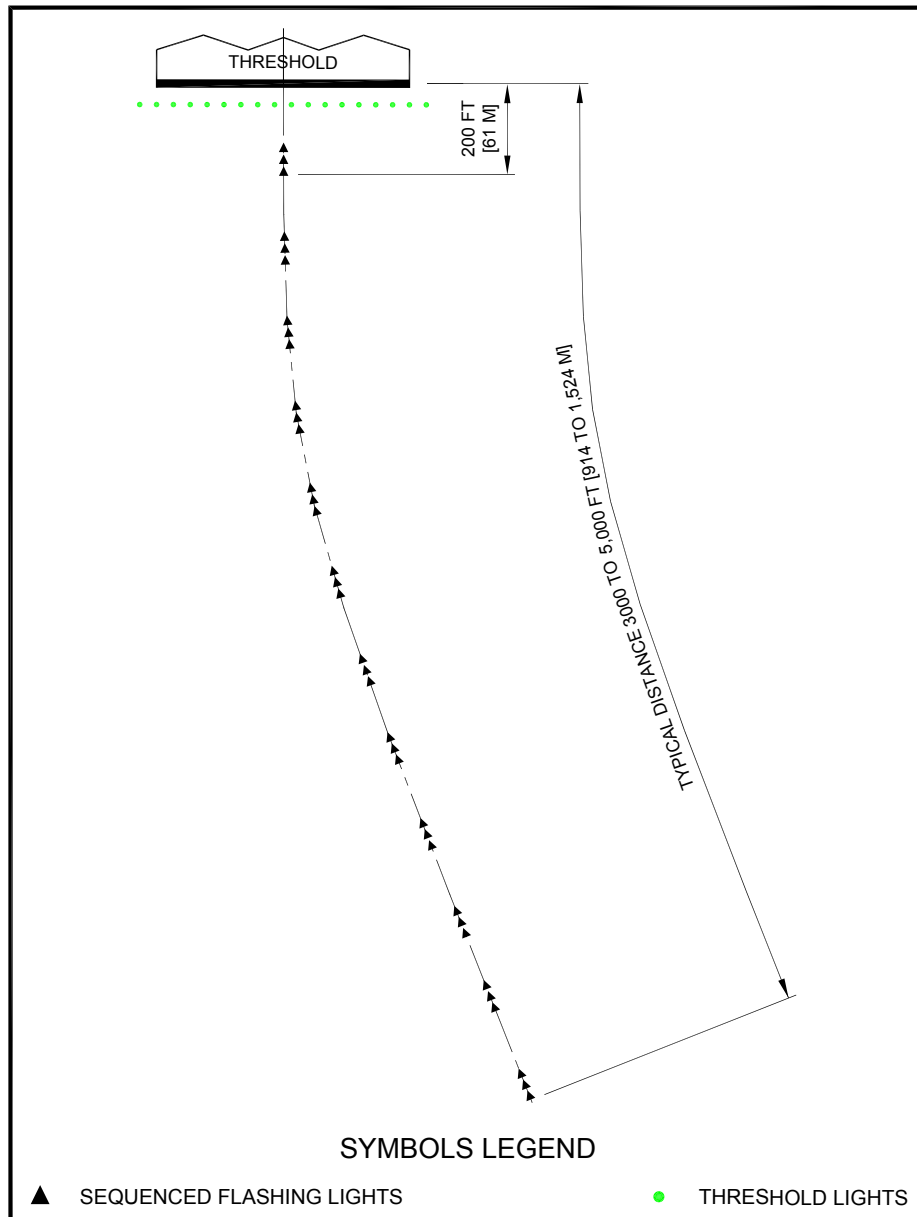
**Figure 6-13. Omnidirectional Airport Lighting System (ODALS)**

**b. Land requirements.** An ALS requires a site centered on the extended runway centerline. It is 400 feet (122 m) wide. It starts at the threshold and extends 200 feet (61 m) beyond the outermost light of the ALS.

**c. Clearance requirements.** A clear line of sight (LOS) is required between approaching aircraft and all lights in an ALS.

**622. Approach Lead-In Lighting System (LDIN).**

LDINs consist of at least three flashing lights installed at or near ground level to define the desired course to an ALS or to a runway threshold. See Figure 6-14.



**Figure 6-14. Lead-in Lighting System (LDIN)**

**a. LDIN configuration.** Each LDIN installation is unique. LDIN is designed to overcome problems associated with hazardous terrain, obstructions, noise sensitive areas, etc. LDIN systems may be curved, straight, or a combination thereof. The lights are placed on the desired approach path, beginning at a point within visual range of the final approach. Generally the lights are spaced at 3,000-foot (914 m) intervals.

**b. Land requirements.** Sufficient land or property interest to permit installation and operation of the lights, together with the right to keep the lights visible to approaching aircraft, is required.

**c. Clearance requirements.** A clear line-of-sight is required between approaching aircraft and the next light ahead of the aircraft. At many non-towered airports, the intensity of the lighting system can be adjusted by the pilot.

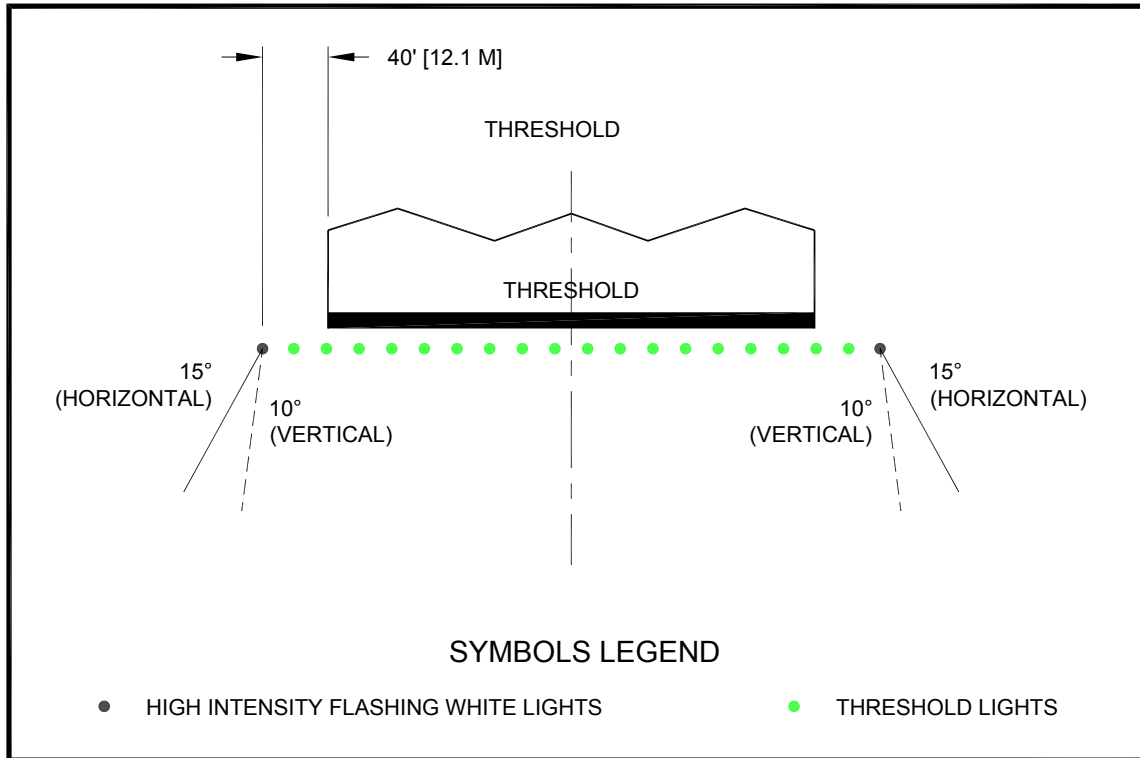


**Figure 6-15. Approach LDIN facility**

### **623. Runway End Identifier Lighting (REIL).**

A REIL consists of a flashing white high-intensity light installed at each approach end corner of a runway. The lights are directed toward the approach zone, enabling the pilot to identify the runway threshold, refer to [Figure 6-16](#). These lights consist of two synchronized flashing unidirectional or omnidirectional (360 degree) lights, one on each side of the runway threshold. The function of the REIL is to provide rapid and positive identification of the end of the runway. REIL systems are effective for identification of a runway surrounded by a preponderance of other lighting or lacking contrast with surrounding terrain. This system is usually installed at non-towered airports and can be activated by a specified radio frequency known to the pilot. Additional information and guidance can be found in [AC 150/5340-30](#) for REIL.





**Figure 6-16. Runway End Identifier Lighting (REIL)**

**a. Location.** The REIL lights units are normally positioned in line with runway threshold lights and at least 40 feet (12 m) from the edge of the runways.

**b. Installation.** Unidirectional REIL units usually are aimed 15 degrees outward from a line parallel to the runway and inclined at an angle of 10 degrees. This standard can be modified because of user complaints of blinding effects, flight inspection findings, and/or environmental impact.



**Figure 6-17. REIL**

**624. Airport rotating beacons.**

Airport rotating beacons indicate the location of an airport by projecting beams of light spaced 180 degrees apart. Airport rotating beacons are required for any airport with runway edge lights. Alternating white/green flashes identify a lighted civil airport. See AC 150/5340-30 for additional guidance.

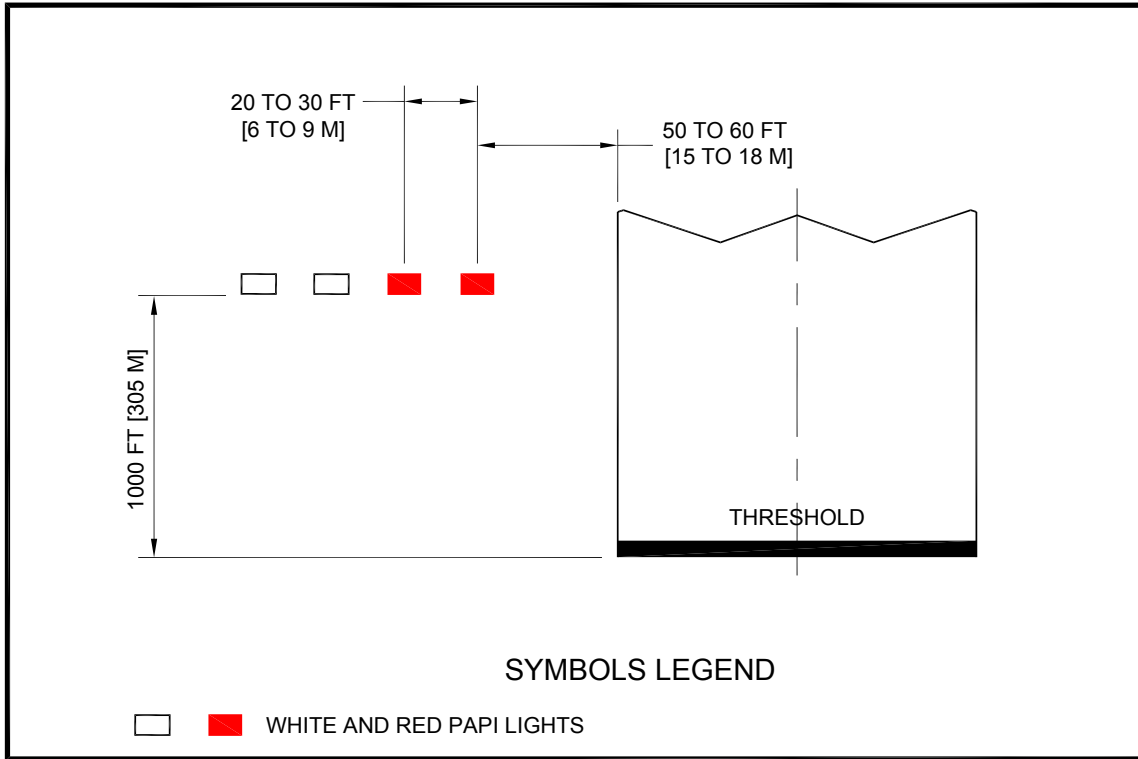
**a. Location.** The beacon is located to preclude interference with pilot or ATCT controller vision. Beacons should be within 5,000 feet (1524 m) of a runway.

**b. Land requirements.** Most beacons are located on airport property. When located off the airport, provide sufficient land or property interest to permit installation and operation of the beacon with the right to keep the beacon visible to approaching aircraft.

**c. Clearance requirements.** A beacon should be mounted high enough above the surface so that the beam sweep, aimed 2 degrees or more above the horizon, is not blocked by any natural or manmade object.

**625. Precision Approach Path Indicator (PAPI).**

A PAPI is a light array positioned beside the runway. It normally consists of four equally spaced light units color-coded to provide a visual indication of an aircraft's position relative to the designated GS for the runway. An abbreviated system consisting of two light units can be used for some categories of aircraft operations. The specific location depends on a number of factors including: obstruction clearance, Threshold Crossing Height (TCH), presence of a GS, and type of aircraft using the runway. Order JO 6850.2 provides guidance for PAPI systems, and AC 150/5340-30 provides additional guidance for the installation of PAPI systems. The Visual Approach Slope Indicator (VASI) is now obsolete. The VASI only provided guidance to heights of 200 ft (61 m).



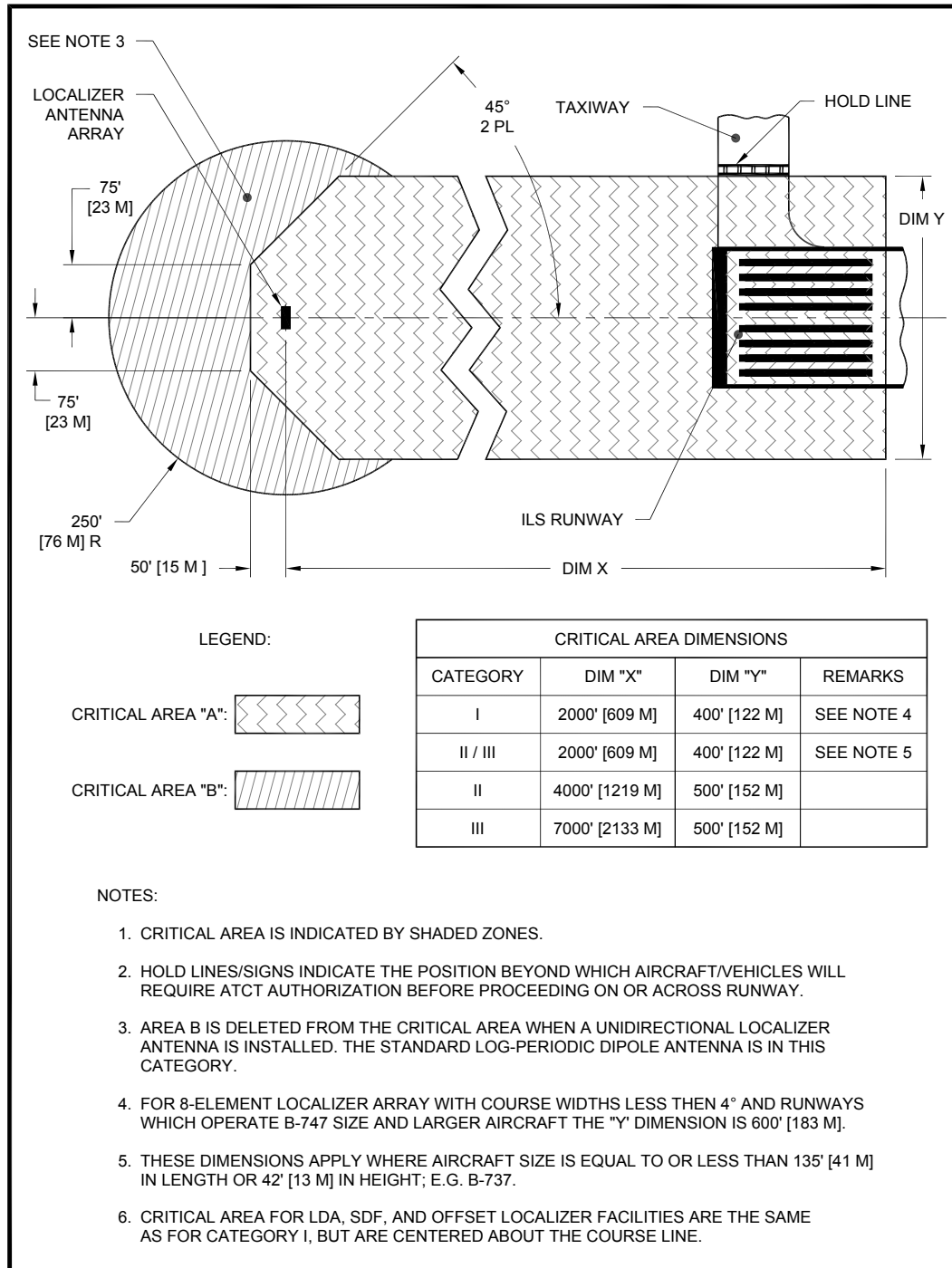
**Figure 6-18. Precision Approach Path Indicator (PAPI)**



**Figure 6-19. PAPI light boxes**

**626. Instrument Landing System (ILS).**

The ILS provides pilots with electronic guidance for aircraft alignment, descent gradient, and position until visual contact confirms the runway alignment and location. Order 6750.16 provides guidance for engineering personnel engaged in siting ILS components. Figure 6-20 illustrates LOC component locations.



**Figure 6-20. Instrument Landing System (ILS) Localizer (LOC) siting and critical area**

**a. General.** The ILS uses a line-of-sight signal from the LOC antenna and marker beacons and a reflected signal from the ground plane in front of the GS antenna. FAA LOC and GS facilities are maintained by ATO Technical Operations field offices if ATO-installed.

(1) ILS antenna systems are susceptible to signal interference sources such as power lines, fences, metal buildings, cell phones, etc.

(2) Since ILS uses the ground in front of the GS antenna to develop the signal, this area should be free of vegetation and graded to remove surface irregularities.

(3) GS and LOC equipment shelters are located near, but are not a physical part of, the antenna installation.

**b. LOC antenna.** The LOC signal is used to establish and maintain the aircraft's horizontal position until visual contact confirms the runway alignment and location.

(1) The LOC antenna is usually sited on the extended runway centerline, outside the RSA between 1,000 to 2,000 feet (305 to 610 m) beyond the stop end of the runway. Where it is not practicable to locate the antenna beyond the end of the RSA, consider offsetting the LOC to keep it clear of the RSA (see paragraph 307). Consult with the FAA Airports Regional Office or Airports District Office (ADO) and ATO for guidance.

(2) The critical area depicted in [Figure 6-20](#) surrounding the LOC antenna and extending toward and overlying the stop end of the runway should be clear of objects and high growth of vegetation.

(3) The critical area should be smoothly graded. A constant +1.0 percent to -1.50 percent longitudinal grade with respect to the antenna is recommended. Transverse grades should range from -0.5 percent to -3.0 percent, with smooth transitions between grade changes. Antenna supports are frangible and foundations should be flush with the ground.

(4) The LOC equipment shelter is placed at least 250 feet (76 m) to either side of the antenna array and within 30 degrees of the extended longitudinal axis of the antenna array.



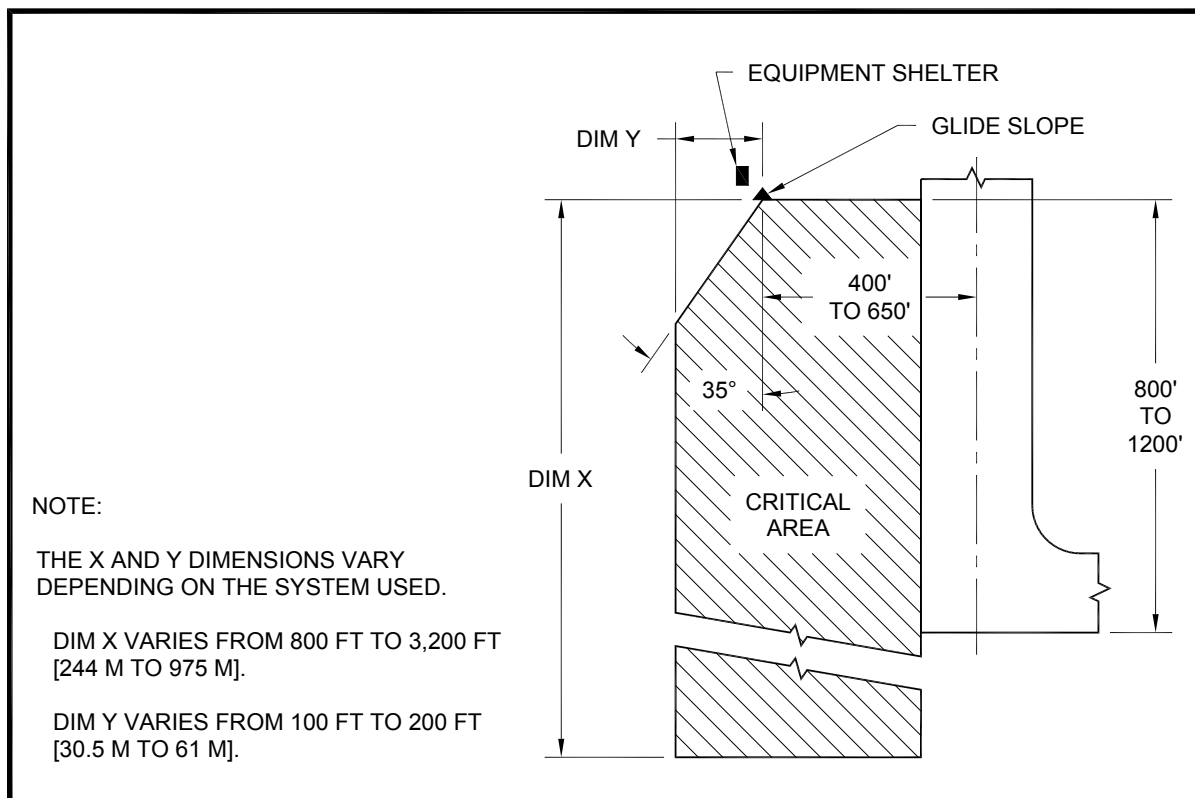
**Figure 6-21. LOC 8-antenna array**



**Figure 6-22. LOC 14-antenna array**

c. **GS antenna.** The GS signal is used to establish and maintain the aircraft's descent rate until visual contact confirms the runway alignment and location.

(1) The GS antenna may be located on either side of the runway. The most reliable operation is obtained when the GS is located on the side of the runway offering the least possibility of signal reflections from buildings, power lines, vehicles, aircraft, etc. The GS critical area is illustrated in [Figure 6-23](#).



**Figure 6-23. Glideslope (GS) siting and critical area**

(2) Signal quality is dependent upon the type of antenna used and the extent of reasonably level ground immediately in front of the antenna.

(3) The GS equipment shelter is located behind the antenna and a minimum of 400 feet (122 m) from the runway centerline.



**Figure 6-24. GS antenna and equipment shelter**

#### **627. Distance Measuring Equipment (DME).**

DMEs may be installed as an ancillary aid to the ILS. The DME is usually co-located at the LOC when used as a component of the ILS. DME provides pilots with a slant range measurement of distance to the runway in nautical miles. DMEs are augmenting or replacing markers in many installations. The DME is a terminal area or en route navigation facility that provides the pilot with a direct readout indication of aircraft distance from the identified DME. It can be co-located with a VHF Omnidirectional Range (VOR) and/or a LOC shelter. Refer to [Order 6780.5](#) for guidance on DME installation.



**Figure 6-25. Distance Measuring Equipment (DME) antenna**

**628. Runway Visual Range (RVR).**

RVR measures the atmospheric transmissivity along runways and translates this visibility value to the air traffic user. RVRs are needed to support increased landing capacity at existing airports, and for ILS installations. RVR visibility readings assist ATCT controllers when issuing control instructions and to avoid interfering operations within ILS critical areas at controlled airports. RVR systems are also used at non-towered airports. Each RVR system consists of: Visibility Sensor, Ambient Light Sensor, Runway Light Intensity Monitor, Data Processing Unit and Controller Display(s). The sensor units are located in the runway environment. Newer units consist of a single-point visibility sensor.



**Figure 6-26. Touchdown Runway Visual Range (RVR)**

**a. Number.** The number of RVRs required depends upon the runway approach category and physical length.

- (1) CAT-I runways require only a touchdown RVR.
- (2) CAT-II runways with authorized visibility minimums down to 1,600 feet RVR require only a touchdown RVR. Minimums below 1,600 feet RVR require touchdown and



rollout RVRs. CAT II runways more than 8,000 feet (2438 m) in length require touchdown, rollout, and midpoint RVRs.

(3) CAT-III runways with visibility minimums below 1,200 feet RVR require touchdown, midpoint, and rollout RVRs.

**b. Longitudinal location.**

(1) Touchdown RVR visibility sensors are located 0 to 2,500 feet (0-750 m) from the runway threshold, normally behind the glideslope antenna or PAPI.

(2) Rollout RVR visibility sensors are located 0 to 2,500 feet (0-750 m) from the threshold at the rollout end of the runway, normally behind the glideslope antenna or PAPI.

(3) Mid-point RVR visibility sensors are located within 1,000 feet (300 meters) of the center point of the runway.

(4) Runways longer than 12,000 feet (3600 m) may require four RVR visibility sensors to adequately support low visibility operations to both ends of the runway.

**c. Lateral Location.** RVR installations are located adjacent to the instrument runway.

(1) Single-point visibility sensor installations are located at least 400 feet (122 m) from the runway centerline and 150 feet (46 m) from a taxiway centerline.

(2) Transmissometer projectors are located at least 400 feet (122 m) from the runway centerline and 150 feet (46 m) from a taxiway centerline. Receivers are located between 250 feet (76 m) and 1,000 feet (305 m) from the runway centerline.

**629. Very High Frequency Omnidirectional Range (VOR).**

VOR is a system radiating VHF radio signals to compatible airborne receivers. It gives pilots a direct indication of bearing relative to the facility. Refer to Order 6820.10.

**a.** VOR stations have co-located DME or Tactical Air Navigation (TACAN); the latter includes both the DME distance feature and a separate TACAN azimuth feature that provides data similar to a VOR. A co-located VOR and TACAN beacon is called a VHF Omnidirectional Range Collocated Tactical Air (VORTAC). A VOR co-located only with DME is called a VOR-DME. A VOR radial with a DME distance allows a one-station position fix. Both VOR-DMEs and TACANs share the same DME system.

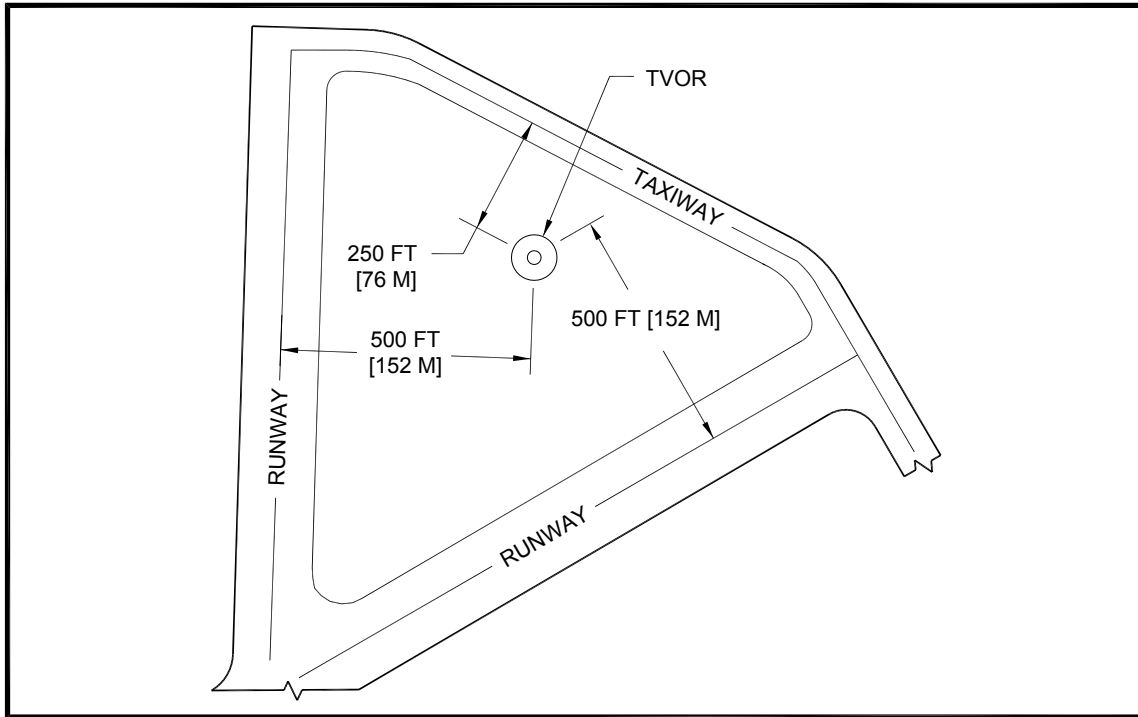
**b.** There are three types of VORs: High Altitude, Low Altitude and Terminal. Figure 6-27 depicts a High Altitude/en route VOR facility and Figure 6-28 shows a Terminal Very High Frequency Omnidirectional Range (TVOR) facility, which is usually located near or at an airport. Figure 6-29 and Figure 6-30 show clearance requirements for a VOR.



**Figure 6-27. Enroute VHF Omnidirectional Range (VOR) facility**

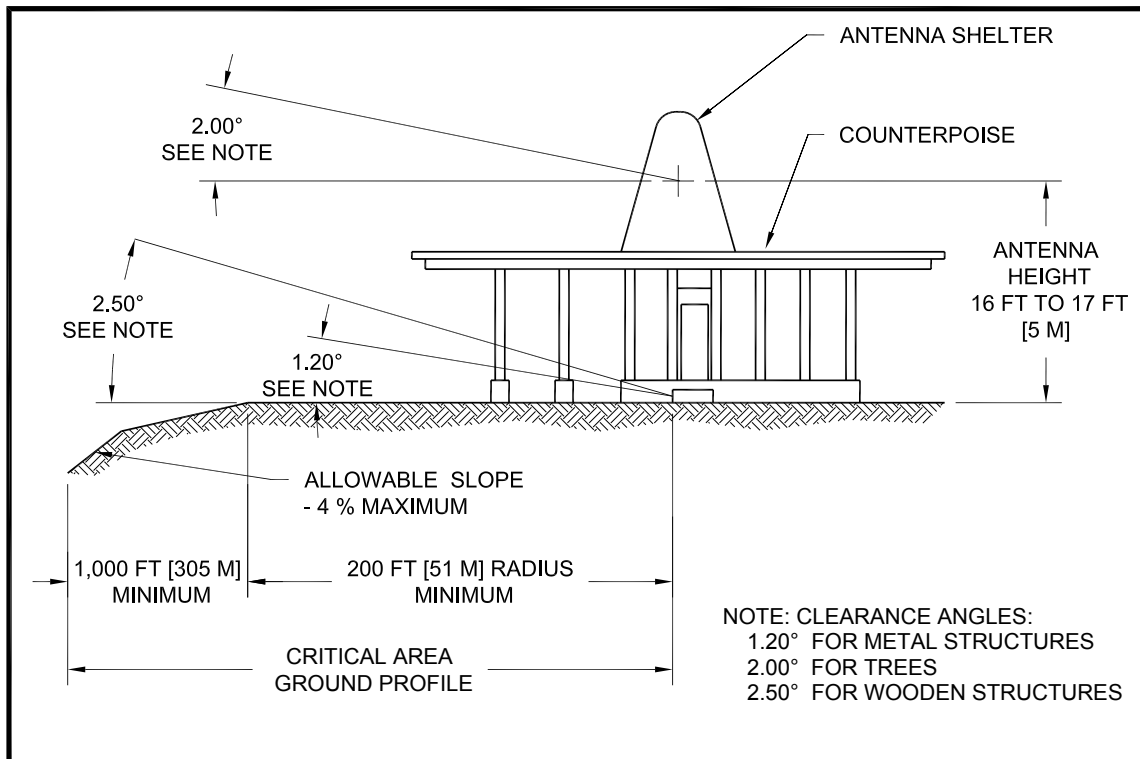


**Figure 6-28. Terminal VOR (TVOR) facility**



Note: See [Order 6820.10](#) for VOR siting details.

**Figure 6-29. TVOR installation**



**Figure 6-30. TVOR clearances**

**630. Non-Directional Beacon (NDB).**

A non-directional beacon is a radio beacon that aids the pilot of an aircraft equipped with direction finding equipment. It can be part of an ILS. NDBs are most commonly used as compass locators for the outer marker of an ILS. NDBs may designate the starting area for an ILS approach or a path to follow for a standard terminal arrival procedure.



**Figure 6-31. Non-Directional Beacon (NDB) facility**

**631. Segmented circles and wind cones.**

A wind cone visually indicates prevailing wind direction at a particular location on an airfield or heliport. The segmented circle provides visual indication of current airport operations such as active landing direction and traffic patterns. Airports have no more than one segmented circle that is collocated with a wind cone. Additional (supplemental) wind cones are not provided with a segmented circle. Wind cones are commonly supplied with a single obstruction light and four floodlights to illuminate the windsock. [AC 150/5340-5](#) provides additional guidance for segmented circles and [AC 150/5340-30](#) provides additional guidance for wind cones.



**Figure 6-32. Segmented circle and wind cone**

### 632. Automated Surface Observing System (ASOS) and Automated Weather Observing System (AWOS).

Automatic recording instruments have been developed for measuring cloud cover and ceiling, visibility, wind speed and direction, temperature, dew point, precipitation accumulation, icing (freezing rain), sea level pressure for altimeter setting, and to detect lightning. This equipment is often installed at the best location that will provide observations that are representative of the meteorological conditions affecting aviation operations. However, the equipment is not installed inside runway or taxiway OFAs, runway or taxiway safety areas, the Runway Obstacle Free Zone (ROFZ), or instrument flight procedures surfaces and is often installed near glides slope installations. Specific siting and installation guidance can be found in [Order 6560.20](#) and [AC 150/5220-16](#).



**Figure 6-33. Automated Surface Observing System (ASOS) weather sensors suite**

### 633. Weather Camera (WCAM).

A WCAM provides aircraft with near real-time photographic weather images via the Hypertext Transfer Protocol (HTTP). These cameras are widely used in the western region of the United States and specifically in Alaska. Alaska's remote destinations, ruggedness, and continuously changing weather conditions require remote weather monitoring equipment. When located near a landing strip or runway, such equipment complies with [Part 77](#) surfaces.



**Figure 6-34. Weather Camera (WCAM) pole**

**634. Wind Equipment F-400 (WEF).**

This equipment measures wind speed and direction. There are numerous small airports that lack control towers to provide wind speed and direction information. Typical wind equipment pole is 30 feet (9 m) tall. Locating wind sensors away from structures that may cause artificial wind profiles is critical. The siting of the tilt-down pole should comply with Part 77 surfaces. For further detail, consult with the FAA Orders for ASOS and/or AWOS siting criteria referenced in paragraph 632.



**Figure 6-35. Weather equipment sensor pole**

**635. Low Level Windshear Alert System (LLWAS).**

LLWAS measures wind speed and direction at remote sensor station sites situated around an airport. Each equipped airport may have as few as 6 or as many as 12 remote anemometer stations. The remote sensor data received is transmitted to a master station, which generates warnings when windshear or microburst conditions are detected. Current wind speed and direction data and warnings are displayed for approach controllers in the Terminal Radar Approach Control Facility (TRACON) and for ground controllers in the ATCT. Siting guidelines for LLWAS remote facilities are referenced in Order 6560.21.



**Figure 6-36. Low Level Windshear Alert System (LLWAS) sensor pole**

**636. Runway Status Lights (RWSL).**

The RWSL system provides lights on runways and taxiways, illuminating when it is unsafe to enter, cross, or begin takeoff on a runway. The lights indicate runway status and increase a pilot's situational awareness. The system is automated based on inputs from surface and terminal surveillance systems. Airport surveillance sensor inputs are processed through a light control logic that commands in-pavement lights to illuminate red when there is traffic on or approaching the runway. One component, Runway Entrance Lights (REL), is located on entrance taxiways and indicates to aircraft crossing or entering a runway from intersecting taxiways that it is unsafe to move forward. The other component, Takeoff Hold Lights (THL), is located on the runway and indicates to aircraft in position for takeoff that it is unsafe to proceed.

**637. to 699. Reserved.**

**Page intentionally left blank.**



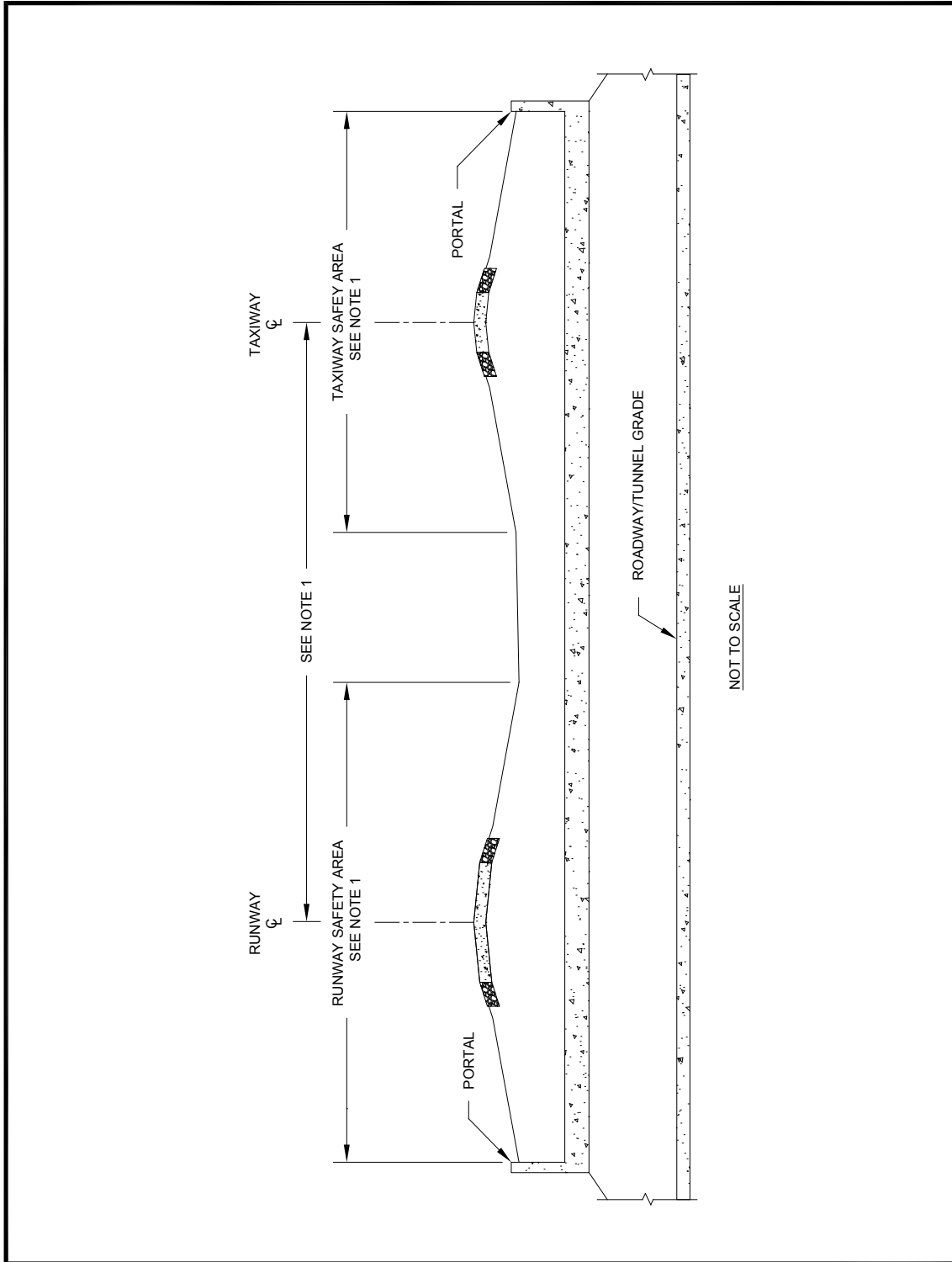
## Chapter 7. Airfield Bridges and Tunnels

### 701. General.

This chapter presents guidance for project development and general design standards and considerations for bridges and tunnels on airports. Due to the unique nature and wide variety of possible structures, this chapter is not intended as a structural design guide. Airfield design can include structures such as bridges or tunnels when airfield expansion is constrained by the presence of features such as roadways, railways, and bodies of water or as needed to develop airports as true multi-modal facilities. Examples of such structures include a continuous tunnel for a runway/parallel taxiway facility over a state highway (see [Figure 7-1](#) and [Figure 7-2](#)), a taxiway bridge crossing an airport entrance road (see [Figure 7-3](#)), or a tunnel under an apron for passenger trains or baggage tugs. For safety as well as economic reasons, airport operators should try to avoid the construction of bridges whenever possible. Preference should be given to relocation of the constraining feature, typically a public road.



**Figure 7-1. Tunnel under a runway and parallel taxiway**



**Notes:**

1. Width of safety areas and centerline separation distances between runways to parallel taxiways vary according to the airplane design group. See interactive [Table 3-5](#).
2. Roadway tunnels normally have slight longitudinal gradient and some type of retaining wall at portals.

**Figure 7-2. Cross-section of a tunnel under a runway and taxiway**



**Figure 7-3. Airfield bridge**

**702. Siting guidelines.**

When airfield structures are required, applying the following concepts will help minimize the number of structures required, as well as any associated problems:

- a.** Route or reroute the constraining feature(s) so that the least number of runways and taxiways are affected.
- b.** Co-align the constraining feature(s), including utilities, so that all can be bridged with a single structure.
- c.** Locate bridges along runway and straight portions of taxiways and away from intersections or exits to facilitate aircraft approaching the bridge under all weather conditions.
- d.** Avoid bridge locations, to the extent possible, that have an adverse effect upon the airport's drainage systems, utility service lines, airfield lighting circuits, Instrument Landing System (ILS), or Approach Lighting System (ALS).
- e.** Establish bridges with near flat vertical grades. Avoid pronounced gradient changes to roadway or structure below the bridge to facilitate a near flat vertical grade for the runway and/or taxiway above. Use minimum grades necessary for drainage purposes in accordance with AC 150/5320-5.

**f.** Provisions should be made for service vehicle and Aircraft Rescue and Fire Fighting (ARFF) access when designing bridges. Refer to paragraph 706.d for further guidance.

### **703. Dimensional criteria.**

While the design of a bridge is governed by the authority having jurisdiction, there are issues unique to airports that need to be observed. Dimensional requirements are prescribed below:

**a. Length.** Bridge length is measured along the runway or taxiway centerline. While minimum lengths are preferable and realized when the constraining feature crosses at right angles, other overriding factors may cause the constraining feature to cross on a skewed or curved alignment.

**b. Width.** Bridge width is measured perpendicular to the runway or taxiway centerline. Safety Area standards require that the width of any runway/taxiway bridge must never be less than the runway/taxiway safety area. When both the runway and parallel taxiway pass over a surface feature, it is good practice to construct the bridge or tunnel to the full width. Constructing the bridge without a gap between the Runway Safety Area (RSA) and taxiway safety area will facilitate access by emergency vehicles.

**c. Grading.** Grading standards for runways and taxiways specified elsewhere in this AC apply.

**d. Height.** Bridge height is the vertical clearance provided over the crossed surface/mode while maintaining the runway/taxiway grade. Contact the appropriate authority for the required vertical clearance.

**e. Clearances.** Bridges: No structural members should project more than 3 inches (76 mm) above grade, with the exception of parapets. Parapets should be constructed at a height of 12 inches (30 cm) to help contain aircraft and vehicles that wander to the pavement edge. Construct parapets to the strength requirements of federal highway standards.

### **704. Load considerations.**

Design runway and taxiway bridges to support both static and dynamic loads imposed by the heaviest aircraft expected to use the structures, as well as any concentrated loads due to the main gear configurations. Airport operators should evaluate the future need to accommodate heavier aircraft when designing bridge structures. Overdesign is preferable to the cost and/or operational penalties of replacing or strengthening an under-designed structure at a later date. The use of a 20% - 25% increase in aircraft loading to account for fleet growth is not an unreasonable value to consider during design. Design Load considerations somewhat unique to airfield bridges can include runway load factors due to dynamic loading, longitudinal loads due to braking forces, and transverse loads caused by wind on large aircraft. Braking loads as high as 0.7G (for no-slip brakes) must be anticipated on bridge decks subject to direct wheel loads.

**705. Marking and lighting.**

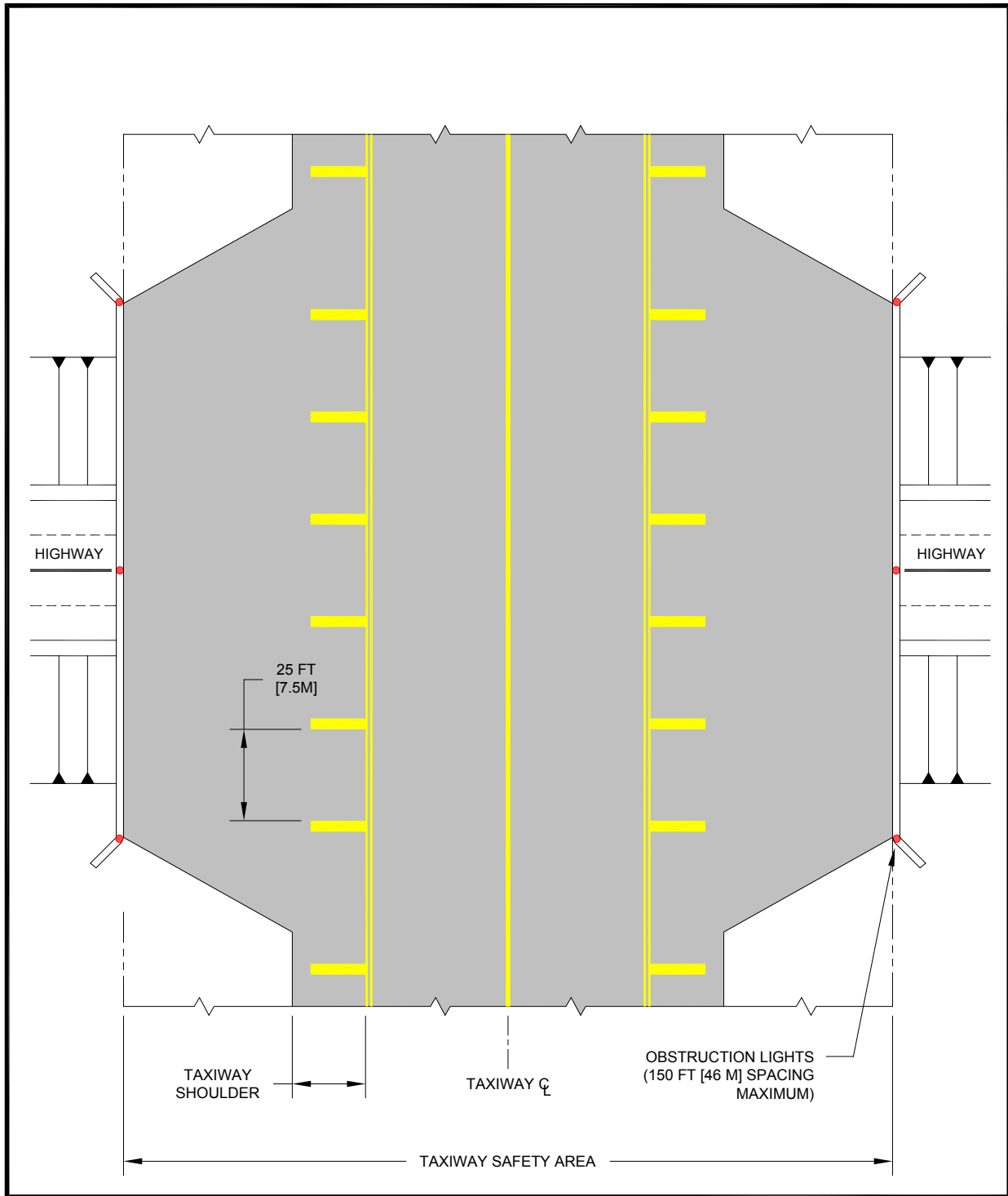
All taxiway routes and runways supported by bridges or tunnels are marked, lighted and signed in accordance with the standards in AC 150/5340-1, AC 150/5340-18, and AC 150/5340-30, and other pertinent ACs in the 150/5340 series. The following marking and lighting is in addition to the standard marking and lighting specified in ACs of the 150/5340 series.

- a. Identify bridge edges/tunnel portals with a minimum of three equally-spaced L-810 obstruction lights on each side of the bridge structure, as shown in Figure 7-4.
- b. Paint 3-foot (1 m) yellow stripes spaced 25 feet (7.5 m) apart on taxiway shoulders on bridge decks, as shown in Figure 7-4. See AC 150/5340-1.
- c. Centerline lighting is recommended. Consider reducing the spacing between successive taxiway light fixtures (whether on the edge or centerline) to less than lighting standards of AC 150/5340-30 on the portion of the taxiway pavement crossing the bridge/tunnel.

**706. Other considerations.**

The preceding paragraphs cover design requirements applicable to all runway and taxiway bridges. The following identify additional design features that may be necessary as part of a specific runway or taxiway bridge project.

- a. **Security measures and fences.** Security measures and fences should be provided adjacent to the bridge/tunnel to prevent inadvertent entry of persons, vehicles, or animals into operational areas. Coordination with Transportation Security Administration may need to be considered. Please refer to Part 1542.
- b. **Tunnel cover.** Providing select earth cover between the bridge deck and pavement will make pavements less susceptible to freezing because the select earth cover acts as an insulator to reduce ice formation on bridges. Materials between the bridge deck and paved runway/taxiway sections and shoulders should be in accordance with the construction standards in AC 150/5320-6 and AC 150/5370-10.
- c. **Pavement heating/auto-deicing sprayers.** Where pavement freezing is a problem on bridges, in-pavement heating or the installation of auto-deicing sprayers may be desirable. Accordingly, the drainage system needs to be capable of accepting melted runoff without refreezing or flooding the bridged surface. Melt-off containing deicing fluids may require additional mitigation measures for environmental compliance.
- d. **Service roads.** Airport emergency, maintenance, and service equipment may use a runway or taxiway bridge if their presence does not interfere with aircraft operations or increase the potential for runway incursions. Airports with an excessive volume of internal ground vehicle traffic should construct a separate bridge specifically for this traffic. The vehicular bridge is subject to runway and taxiway centerline to fixed/movable object criteria.



**Notes:**

1. The shoulder area assumes a fully-closed cover instead of a partial cover open to traffic below.
2. See [AC 150/5340-1](#) for taxiway marking details.

**Figure 7-4. Shoulder markings for taxiway bridges**

**e. Mechanical ventilation for tunnels.** The need for mechanical ventilation may be required. When mechanical ventilation is deemed necessary, all above-ground components need to be located so that they are not a hazard to aeronautical operations. Contact the local authority for requirements.

**f. Tunnel lighting.** The need for artificial lighting of the roadway beneath the bridge will depend on its length. Emergency lighting and lane control signals may also be necessary. Contact the local authority for requirements.

**g. Light poles.** Lights along the roadway prior to the bridge/tunnel may present special aeronautical problems. Light poles along roadways must not penetrate Part 77 surfaces unless an FAA aeronautical study determines they will not be hazards. The light from the fixtures should not cause glare or distract pilots or airport control tower personnel. Figure 7-5 illustrates a taxiway bridge with a roadway pole lighting application.



**Figure 7-5. Example of a structural deck with lighted depressed roadway**

**h. Bridge clearance signage.** Signage should clearly identify the available vertical clearance under all runway/taxiway bridges to avoid over-height vehicles damaging the structure and/or impacting airport operations. Contact the local authority for requirements.

**i. Drainage.** Adequate drainage must be provided for roadways that pass under/through the bridge/tunnels. Contact the local authority for requirements.

**j. Fire protection and egress.** National Fire Protection Association (NFPA) standards are a source of additional information and may apply. Contact the local authority for requirements.

**707. Storm water structures.**

Culverts and large pipe structures may be necessary to allow drainage under runway, taxiway or service-perimeter roadways or to convey natural waterways across the airfield. AC 150/5320-5 provides guidance on airfield drainage. Refer to AC 150/5200-33 for guidance on land uses that have the potential to attract hazardous wildlife on or near public-use airports.

**708. to 799. Reserved.**

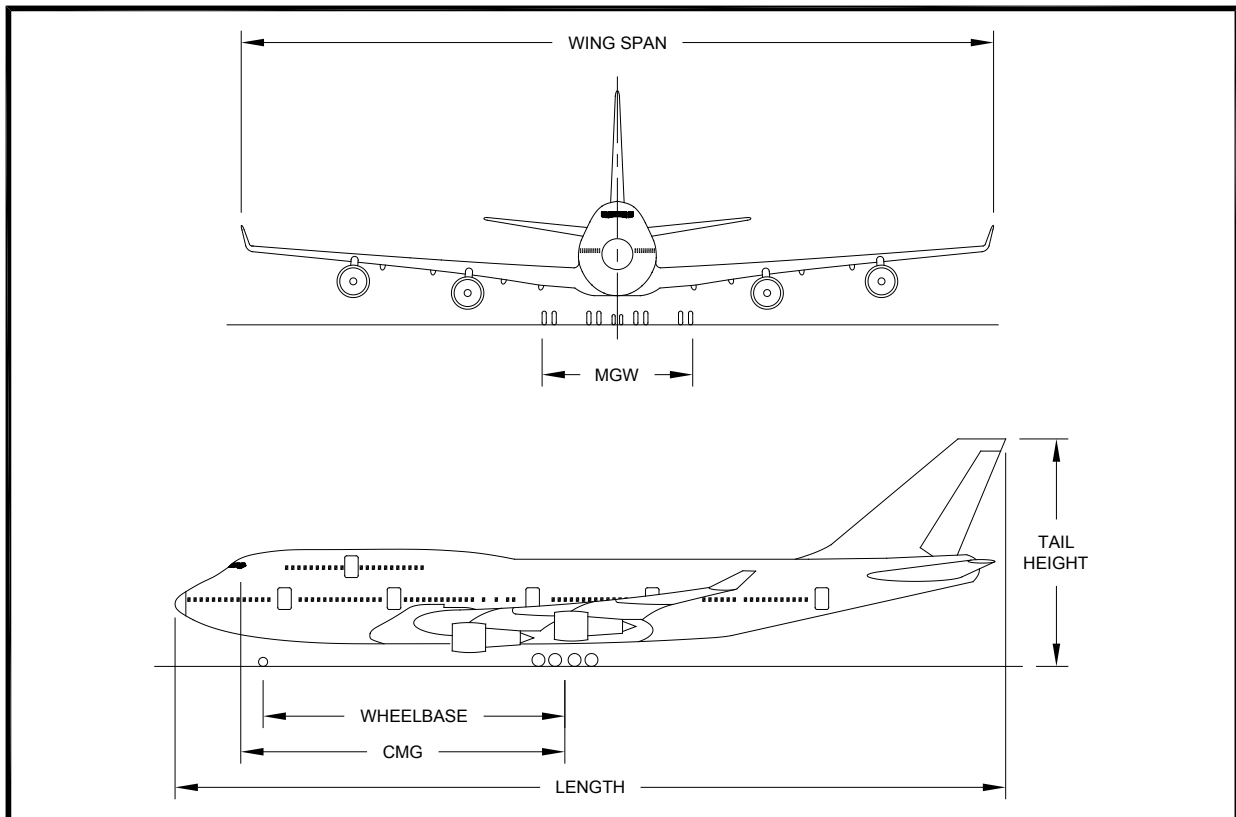


## Appendix 1. Aircraft Characteristics

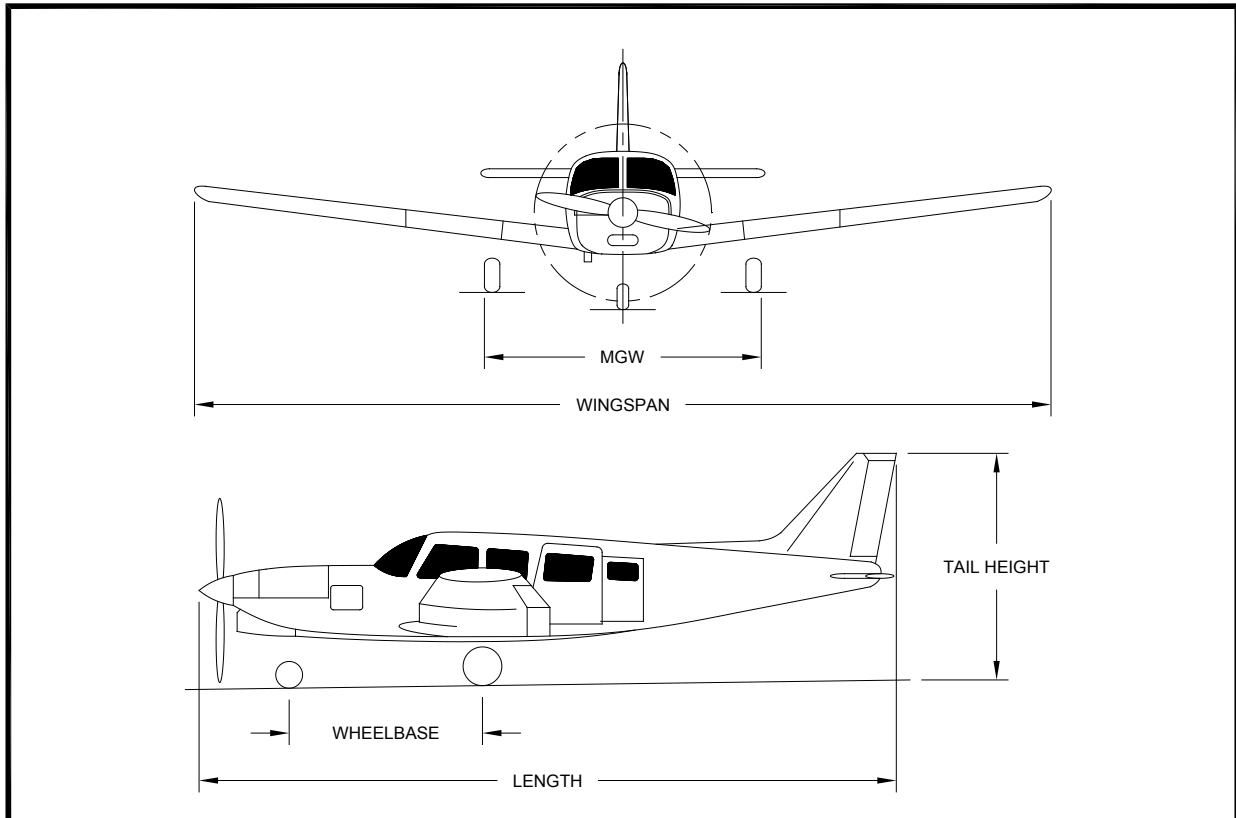
**A1-1. Basic aircraft characteristics.** This appendix provides the airfield designer with basic aircraft characteristics for common aircraft as needed to perform such design functions as taxiway fillet layout and taxiway to taxiway separation requirements. Table A1-1 has been developed from the best manufacturers' information available at the time of issuance of this AC.

**Note:** *These data do not include all aircraft or versions of aircraft the designer may encounter, nor have these data been fully verified. Please consult the manufacturer's technical specifications if there is a question on a specific aircraft. Eventually the Airport Geographic Information System (GIS) website will include a more comprehensive and up to date database. When using this database consider the following:*

- *In accordance with the cockpit over centerline design method, the Cockpit to Main Gear (CMG) dimension will be used in lieu of wheelbase for aircraft (typically larger) where the cockpit is located forward of the nose gear. For aircraft with the cockpit located aft of the nose gear, use the wheelbase in lieu of CMG to determine the Taxiway Design Group (TDG). Refer to Figure A1-1 and Figure A1-2.*



**Figure A1-1. Typical dimensions of large aircraft**



**Figure A1-2. Typical dimensions of small aircraft**

Sources of the information provide in this appendix include aircraft manufacturers' websites and various databases:

- FAA Aircraft Characteristics  
Database: [http://www.faa.gov/airports/engineering/aircraft\\_char\\_database/](http://www.faa.gov/airports/engineering/aircraft_char_database/)
- Eurocontrol Aircraft Performance Database  
V2.0: <http://elearning.ians.lu/aircraftperformance/>
- Airbus Airplane Characteristics for Airport  
Planning: <http://www.airbus.com/support/maintenance-engineering/technical-data/aircraft-characteristics/>
- Boeing Airplane Characteristics for Airport  
Planning: [http://www.boeing.com/commercial/airports/plan\\_manuals.html](http://www.boeing.com/commercial/airports/plan_manuals.html)
- Embraer Aircraft Characteristics for Airport  
Planning: <http://www.embraercommercialjets.com/#/en/downloads>

**A1-2. Background.**

**a.** Aircraft physical characteristics have operational and economic significance which materially affect an airport's design, development, and operation. They influence the design aspects of runways, taxiways, ramps, aprons, servicing facilities, gates, and life safety facilities. Their consideration when planning a new airport or improving existing airport facilities maximizes their utilization and safety. Airport designers should consider anticipated growth in air traffic and the effects of near future model aircraft operating weights and physical dimensions.

**b.** Military aircraft frequently operate at civil airports. Joint-use airports should also meet the physical characteristics for military aircraft. Hence, during airport facility design, consider routine military operations such as medical evacuation, strategic deployment and dispersal, and Reserve and National Guard training missions.

**A1-3. Aircraft arranged by aircraft manufacturer, and Runway Design Code (RDC).**

**a. Aircraft characteristics database.** The FAA is redesigning the Aircraft Characteristic Database and incorporating it in the Airport Design section of the FAA Airport GIS System (see <https://airports-gis.faa.gov/airportgis/>). The FAA expects to complete this work in the near future. See [http://www.faa.gov/airports/engineering/aircraft\\_char\\_database/](http://www.faa.gov/airports/engineering/aircraft_char_database/).

**b. Access to database.** Until the new database is complete, aircraft characteristics data is available below as well as on the FAA website at: [http://www.faa.gov/airports/engineering/aircraft\\_char\\_database/](http://www.faa.gov/airports/engineering/aircraft_char_database/)). The database may include information on aircraft characteristics provided subsequent to the date of this AC.

**Table A1-1. Aircraft characteristics database – sorted by aircraft manufacturer/model**

Manufacturer	Aircraft	AAC	ADG	TDG	Wing-span	Tail Height	Length	CMG	Wheel-base	MGW Outer to Outer	MTOW	V <sub>REF</sub> / Approach Speed
					ft (m)	ft (m)	ft (m)	ft (m)	ft (m)	ft (m)	lbs (kg)	kts
Airbus	A-300	C	IV	5	147.1	55	175.9	75	61	36.1	363,763	137
					(44.83)	(16.72)	(53.61)	(22.86)	(18.6)	(11)	(165000)	
Airbus	A-300-600	C	IV	5	147.1	55	177	75	61	36	375,888	137
					(44.84)	(16.7)	(54.1)	(22.87)	(18.6)	(10.96)	(170500)	
Airbus	A-310	C	IV	5	144	52.1	153.1	63.9	49.9	36	361,558	139
					(43.9)	(15.87)	(46.66)	(19.49)	(15.22)	(10.96)	(164000)	
Airbus	A-318	C	III	3	111.9	42.3	103.2	42.4	33.6	29.4	149,914	121
					(34.1)	(12.89)	(31.45)	(12.91)	(10.25)	(8.95)	(68000)	
Airbus	A-318 Sharklet *	C	III	3	117.5	42.3	103.2	42.4	33.6	29.4	149,914	121
					(35.8)	(12.89)	(31.45)	(12.91)	(10.25)	(8.95)	(68000)	
Airbus	A-319	C	III	3	111.9	39.7	111	44.9	36.2	29.4	166,449	138
					(34.1)	(12.11)	(33.84)	(13.7)	(11.04)	(8.95)	(75500)	
Airbus	A-319 Sharklet	C	III	3	117.5	39.7	111	44.9	36.2	29.4	166,449	126
					(35.8)	(12.11)	(33.84)	(13.7)	(11.04)	(8.95)	(75500)	

\* Preliminary

Manufacturer	Aircraft	AAC	ADG	TDG	Wing-span	Tail Height	Length	CMG	Wheel-base	MGW Outer to Outer	MTOW	V <sub>REF</sub> / Approach Speed
					ft (m)	ft (m)	ft (m)	ft (m)	ft (m)	ft (m)	lbs (kg)	kts
Airbus	A-320	C	III	3	111.9	39.6	123.3	50.2	41.5	29.4	171,961	136
					(34.1)	(12.08)	(37.57)	(15.3)	(12.64)	(8.95)	(78000)	
Airbus	A-320 Sharklet	C	III	3	117.5	39.6	123.3	50.2	41.5	29.4	171,961	136
					(35.8)	(12.08)	(37.57)	(15.3)	(12.64)	(8.95)	(78000)	
Airbus	A-321	C	III	3	111.9	39.7	146	64.2	55.4	29.4	206,132	142
					(34.1)	(12.1)	(44.5)	(19.56)	(16.9)	(8.97)	(93500)	
Airbus	A-321 Sharklet	C	III	3	117.5	39.7	146	64.2	55.4	29.4	206,132	142
					(35.8)	(12.1)	(44.5)	(19.56)	(16.9)	(8.97)	(93500)	
Airbus	A-330-200	C	V	5	197.8	58.2	191.5	86.8	72.8	41.4	524,700	136
					(60.3)	(17.73)	(58.36)	(26.45)	(22.18)	(12.61)	(238000)	
Airbus	A-330-200F	C	V	5	197.8	57.1	191.5	86.8	72.8	41.4	513,677	139
					(60.3)	(17.41)	(58.36)	(26.45)	(22.18)	(12.61)	(233000)	
Airbus	A-330-300	C	V	5	197.8	56.4	209	97.2	83.2	41.4	518,086	137
					(60.3)	(17.18)	(63.69)	(29.64)	(25.37)	(12.61)	(235000)	
Airbus	A-340-200	D	V	5	197.8	56	195	90.1	76.1	41.4	606,271	136
					(60.3)	(17.06)	(59.42)	(27.47)	(23.2)	(12.61)	(275000)	
Airbus	A-340-300	D	V	5	197.8	55.9	209	97.3	83.3	41.4	609,578	138
					(60.3)	(17.04)	(63.69)	(29.67)	(25.4)	(12.61)	(276500)	
Airbus	A-340-500	D	V	6	208.2	57.5	222.9	105.4	91.7	41.4	837,757	146
					(63.45)	(17.53)	(67.93)	(32.13)	(27.95)	(12.61)	(380000)	
Airbus	A-340-600	D	V	6	208.2	58.8	247.3	122.6	108.9	41.4	837,757	153
					(63.45)	(17.93)	(75.36)	(37.38)	(33.2)	(12.61)	(380000)	
Airbus	A-350-900	D	V	5	212.4	57.1	219.5	99.6	94	42.2	590,839	145
					(64.74)	(17.39)	(66.89)	(30.36)	(28.66)	(12.87)	(268000)	
Airbus	A-380-800	D	VI	7	261.6	79.6	238.6	104.6	97.9	47	1,254,430	138
					(79.75)	(24.3)	(72.73)	(31.88)	(29.83)	(14.34)	(569000)	
ATR	Alenia ATR-42-200/300	B	III	2	80.7	24.9	74.5	29	28.8	16	36,817	104
					(25)	(8)	(23)	(9)	(8.8)	(5)	(16700)	
ATR	Alenia ATR-72-200/210	B	III	3	88.9	25.3	89.2	36	35.3	24	47,399	105
					(27)	(8)	(27)	(11)	(10.8)	(7)	(21500)	
Beech	Bonanza V35B	A	I	1B	33.4	7.6	26.3	21	25.1	12	3,400	70
					(10)	(2)	(8)	(6)	(7.7)	(3.5)	(1542)	
Beech	Beech 55 Baron	A	I	1A	37.7	9.5	27.9	7	7	8	5,071	90
					(11)	(3)	(9)	(2)	(2)	(2)	(2300)	
Beech	Beech 60 Duke	B	I	1A	39.4	12.5	33.8	7	7	8	6,768	98
					(12)	(4)	(10)	(2)	(2)	(2)	(3070)	
Beech	King Air F90	B	III	1A	45.9	34.1	39.8	13	13	13	10,950	108
					(14)	(10)	(12)	(4)	(4)	(4)	(4967)	
Beech	100 King Air	B	I	1A	45.9	15.4	40.0	15	15	14	11,795	111
					(14)	(5)	(12)	(5)	(5)	(4)	(5350)	
Boeing	707-320B	C	IV	4	145.8	42.1	152.9	68.4	59	26.3	333,600	128
					(44.4)	(12.8)	(46.6)	(20.85)	(17.9)	(8.02)	(151319)	
Boeing	717-200	C	III	2	93.2	29.8	124.0	55.8	57.8	19.4	121,000	139
					(28.40)	(9.08)	(37.80)	(17.00)	(17.62)	(5.90)	(54,885)	
Boeing	717-200HGW	C	III	3	108.0	34.3	133.2	55.90	57.8	22.9	121,000	139
					(32.9)	(10.4)	(40.6)	(17.04)	(17.6)	(6.98)	(54885)	

Manufacturer	Aircraft	AAC	ADG	TDG	Wing-span	Tail Height	Length	CMG	Wheel-base	MGW Outer to Outer	MTOW	V <sub>REF</sub> / Approach Speed
					ft (m)	ft (m)	ft (m)	ft (m)	ft (m)	ft (m)	lbs (kg)	kts
Boeing	727-100	C	III	3	108.0	34.3	133.2	60.20	53.3	23.0	160,000	124
					(32.90)	(10.40)	(40.60)	(18.34)	(16.2)	(7.01)	(72575)	
Boeing	727-200	C	III	4	107.9	34.9	153.2	70.2	63.3	23.3	210,000	133
					(32.9)	(10.64)	(46.7)	(21.40)	(19.29)	(7.10)	(95254)	
Boeing	727-200/W	C	III	4	109.3	34.9	153.2	70.2	63.3	23.3	210,000	136
					(33.30)	(10.64)	(46.70)	(21.40)	(19.29)	(7.10)	(95,254)	
Boeing	737-100	C	III	3	93.0	37.2	94.0	39.1	13	20.9	110,000	136
					(28.3)	(11.3)	(28.7)	(11.93)	(4)	(6.36)	(49895)	
Boeing	737-200	C	III	3	93.2	36.8	100.1	42.7	37.3	21.0	128,600	133
					(28.40)	(11.22)	(30.50)	(13.00)	(11.37)	(6.40)	(58332)	
Boeing	737-300	C	III	3	94.8	36.6	109.6	45.9	40.8	21.0	138,500	133
					(28.9)	(11.16)	(33.4)	(14.00)	(12.44)	(6.40)	(62823)	
Boeing	737-300/W	C	III	3	102.4	36.6	109.6	45.9	40.8	21.0	138,500	133
					(31.20)	(11.16)	(33.40)	(14.00)	(12.44)	(6.40)	(62,823)	
Boeing	737-400	C	III	3	94.8	36.6	119.4	52.2	40.8	21.0	150,000	139
					(28.9)	(11.16)	(36.40)	(15.90)	(12.44)	(6.40)	(68039)	
Boeing	737-500	C	III	3	94.8	36.6	101.7	41.7	36.3	21.0	133,500	128
					(28.9)	(11.16)	(31.0)	(12.70)	11.6	(6.40)	(60555)	
Boeing	737-500/W	C	III	3	102.0	36.6	101.7	41.7	36.3	21.0	133,500	128
					(31.10)	(11.16)	(31.00)	(12.70)	(11.06)	(6.40)	(60555)	
Boeing	737-600	C	III	3	112.5	41.7	102.4	42.0	36.8	23.0	143,500	125
					(34.30)	(12.71)	(31.20)	(12.80)	(11.22)	(7.00)	(65091)	
Boeing	737-700	C	III	3	112.5	41.7	110.2	46.6	41.3	23.0	154,500	130
					(34.30)	(12.71)	(33.60)	(14.20)	(12.59)	(7.00)	(70080)	
Boeing	737-700W	C	III	3	117.5	41.7	110.2	46.6	41.3	23.0	154,500	130
					(35.80)	(12.71)	(33.60)	(14.20)	(12.59)	(7.00)	(70080)	
Boeing	737-800	D	III	3	112.5	41.2	129.6	56.4	51.2	23.0	174,200	142
					(34.30)	(12.56)	(39.50)	(17.20)	(15.61)	(7.00)	(79016)	
Boeing	737-800W	D	III	3	117.5	41.2	129.6	56.4	51.2	23.0	174,200	142
					(35.80)	(12.56)	(39.50)	(17.20)	(15.61)	(7.00)	(79016)	
Boeing	737-900	D	III	3	112.5	41.2	138.1	61.7	56.3	23.0	174,200	141
					(34.30)	(12.56)	(42.10)	(18.80)	(17.16)	(7.00)	(79016)	
Boeing	737-900W	D	III	3	117.4	41.4	138.2	61.6		23	174,200	141
					(35.8)	(12.6)	(42.1)	(18.78)		(7.00)		
Boeing	737-900ER	D	III	3	112.6	41.4	138.2	61.6	56.3	23	187,700	141
					(34.3)	(12.6)	(42.1)	(18.78)	(17.7)	(7.00)	(85139)	
Boeing	737-900ERW	D	III	3	117.5	41.2	138.1	61.7	56.3	23.0	187,200	141
					(35.80)	(12.56)	(42.10)	(18.80)	(17.16)	(7.00)	(84912)	
Boeing	BBJ	C	III	3	117.4	41.6	110.3	46.6	41.3	23	171,000	132
					(35.8)	(12.7)	(33.6)	(14.20)	(12.6)	(7.0)	(77564)	
Boeing	BBJ2	D	III	3	117.4	41.4	129.5	56.4		23	174,200	142
					(35.8)	(12.6)	(39.5)	(17.2)		(7.00)	(79016)	
Boeing	747-SP	C	V	5	195.5	65.8	184.7	75.1	67.3	40.7	703,000	140
					(59.60)	(20.06)	(56.30)	(22.90)	(20.51)	(12.40)	(318875)	
Boeing	747-100	D	V	5	195.5	64.3	231.0	91.9	84.0	40.7	753,000	144
					(59.60)	(19.60)	(70.40)	(28.00)	(25.60)	(12.40)	(341595)	

Manufacturer	Aircraft	AAC	ADG	TDG	Wing-span	Tail Height	Length	CMG	Wheel-base	MGW Outer to Outer	MTOW	V <sub>REF</sub> / Approach Speed
					ft (m)	ft (m)	ft (m)	ft (m)	ft (m)	ft (m)	lbs (kg)	kts
Boeing	747-200	D	V	5	195.5	64.3	231.0	91.9	84.0	40.7	836,000	150
					(59.60)	(19.60)	(70.40)	(28.00)	(25.60)	(12.40)	(379203)	
Boeing	747-200F	D	V	5	195.8	64.3	229.2	91.7		41.2	833,000	150
					(59.7)	(19.6)	(69.9)	(27.95)		(12.56)	(377843)	
Boeing	747-300	D	V	5	195.5	64.3	231.0	91.9	84.0	40.7	836,000	152
					(59.60)	(19.6)	(70.40)	(28.00)	(25.60)	(12.40)	(379203)	
Boeing	747-400	D	V	5	213.0	64.0	231.9	86.7	84.0	41.3	875,000	157
					(64.9)	(19.5)	(70.7)	(26.40)	(25.6)	(12.60)	(396894)	
Boeing	747-400ER	D	V	5	212.9	64.3	232.0	86.7	84.0	41.3	913,000	157
					(64.90)	(19.60)	(70.70)	(26.4)	(25.60)	(12.60)	(414130)	
Boeing	747-400F	D	V	5	213	64.1	231.9	91.7	84.0	41.3	875,000	158
					(64.9)	(19.5)	(70.7)	(27.95)	(25.6)	(12.60)	(396894)	
Boeing	747-SP	C	V	5	195.7	65.8	184.8	75	67.4	41.1	696,000	140
					(59.6)	(20.1)	(56.3)	(22.86)	(20.5)	(12.53)	(315701)	
Boeing	747-8	D	VI	5	224.4	62.7	250.2	99.8	97.3	41.8	987,000	152
					(68.40)	(19.10)	(76.25)	(30.40)	(29.66)	(12.73)	(447696)	
Boeing	747-8F	D	VI	5	224.4	62.7	250.2	99.8	97.3	41.8	987,000	159
					(68.40)	(19.10)	(76.25)	(30.40)	(29.66)	(12.73)	(447696)	
Boeing	757-200	C	IV	4	125.0	45.1	155.2	72.2	60.0	28.2	255,000	137
					(38.1)	(13.75)	(47.30)	(22.00)	(18.29)	(8.60)	(115666)	
Boeing	757-200/W	C	IV	4	134.8	45.1	155.2	72.2	60.0	28.2	255,000	137
					(41.10)	(13.70)	(47.30)	(22.00)	(18.29)	(8.60)	(115666)	
Boeing	757-300	D	IV	4	125.0	44.9	178.5	85.3	73.3	28.2	270,000	143
					(38.10)	(13.69)	(54.40)	(26.00)	(22.34)	(8.60)	(122470)	
Boeing	757-300/W	D	IV	4	134.8	44.9	181.8	85.3	73.3	28.2	270,000	143
					(41.10)	(13.69)	(55.40)	(26.00)	(22.34)	(8.60)	(122470)	
Boeing	767-200	C	IV	5	156.2	52.9	159.1	79.7	64.6	35.4	361,000	135
					(47.60)	(16.12)	(48.50)	(24.30)	(19.69)	(10.80)	(163747)	
Boeing	767-200ER	D	IV	5	156.2	52.9	159.1	79.7	64.6	35.4	396,000	142
					(47.60)	(16.12)	(48.50)	(24.30)	(19.69)	(10.80)	(179623)	
Boeing	767-300	C	IV	5	156.2	52.6	180.1	82.2	74.8	35.8	361,000	140
					(47.60)	(16.03)	(54.90)	(25.10)	(22.80)	(10.90)	(163747)	
Boeing	767-300ER	D	IV	5	156.2	52.6	180.1	82.2	74.8	35.8	412,000	145
					(47.60)	(16.3)	(54.90)	(25.10)	(22.80)	(10.90)	(186880)	
Boeing	767-300ERW	D	IV	5	167.0	52.6	180.1	82.2	74.8	35.8	412,000	145
					(50.90)	(16.03)	(54.90)	(25.10)	(22.80)	(10.90)	(186880)	
Boeing	767-400	D	IV	5	170.3	55.8	201.3	92	-	36	450,000	150
					(52)	(17)	(61)	(28)		(11)	(204117)	
Boeing	767-400ER	D	IV	5	170.3	55.8	201.4	93.3	85.8	36.1	450,000	150
					(51.90)	(17.01)	(61.40)	(28.4)	(26.15)	(11.00)	(204117)	
Boeing	777-200	C	V	5	199.8	61.5	209.0	94.8	84.9	42.3	545,000	136
					(60.90)	(18.75)	(63.70)	(28.90)	(25.88)	(12.90)	(247208)	
Boeing	777-200ER	C	V	5	199.8	61.5	209.0	94.8	84.9	42.3	656,000	139
					(60.90)	(18.75)	(63.70)	(28.90)	(25.88)	(12.90)	(297557)	
Boeing	777-200LR	C	V	5	212.6	61.5	209.0	94.8	84.9	42.3	766,800	140
					(64.80)	(18.75)	(63.70)	(28.90)	(25.88)	(12.90)	(347815)	

Manufacturer	Aircraft	AAC	ADG	TDG	Wing-span	Tail Height	Length	CMG	Wheel-base	MGW Outer to Outer	MTOW	V <sub>REF</sub> / Approach Speed
					ft (m)	ft (m)	ft (m)	ft (m)	ft (m)	ft (m)	lbs (kg)	kts
Boeing	777-300	D	V	6	199.8	61.5	242.5	112.3	102.4	42.3	660,000	149
					(60.90)	(18.75)	(73.90)	(34.20)	(31.21)	(12.90)	(299371)	
Boeing	777-300ER	D	V	6	212.6	61.8	242.5	112.3	102.4	42.3	775,000	149
					(64.80)	(18.84)	(73.90)	(34.20)	(31.21)	(12.90)	(351534)	
Boeing	787-8	D	V	5	197.3	56.1	186.1	83.4	74.8	38.1	502,500	143
					(60.12)	(17.10)	(56.70)	(25.40)	(22.80)	(11.60)	(227930)	
Boeing	MD-81	C	III	4	107.9	30.2	147.6	70.5	72.4	20.3	142,000	134
					(32.90)	(9.21)	(45.00)	(21.50)	(22.07)	(6.20)	(64410)	
Boeing	MD-82	C	III	4	107.9	30.2	147.6	70.5	72.4	20.3	149,500	134
					(32.90)	(9.21)	(45.00)	(21.50)	(22.07)	(6.20)	(67812)	
Boeing	MD-83	D	III	4	107.9	30.2	147.6	70.5	72.4	20.3	160,000	144
					(32.90)	(9.21)	(45.00)	(21.50)	(22.07)	(6.20)	(72575)	
Boeing	MD-87	C	III	4	107.9	31.2	130.6	70.5	62.9	20.3	149,500	134
					(32.90)	(9.51)	(39.80)	(21.50)	(19.17)	(6.20)	(67812)	
Boeing	MD-88	D	III	4	107.9	30.2	147.6	70.5	72.4	20.3	160,000	144
					(32.90)	(9.21)	(45.00)	(21.50)	(22.07)	(6.20)	(72575)	
Boeing	MD-90	C	III	4	107.9	31.2	152.6	75.1	77.2	20.3	156,000	138
					(32.90)	(9.51)	(46.50)	(22.90)	(23.53)	(6.20)	(70760)	
Boeing	MD-11	D	IV	6	170.5	58.8	202.1	101.7	80.8	41.3	630,500	153
					(51.97)	(17.92)	(61.60)	(31.00)	(24.63)	(12.60)	(285990)	
Boeing	DC8-62	C	IV	4	148.3	43.3	157.5	67.3	60.8	24.9	350,000	138
					(45.20)	(13.20)	(48.00)	(20.50)	(18.53)	(7.60)	(158757)	
Boeing	DC9-15	C	III	2	89.6	27.6	104.3	41.7	43.7	19.7	91,500	132
					(27.30)	(8.41)	(31.80)	(12.70)	(13.32)	(6.00)	(41504)	
Boeing	DC9-20	C	III	2	93.2	27.6	104.3	41.7	43.7	19.7	101,000	126
					(28.40)	(8.41)	(31.80)	(12.70)	(13.32)	(6.00)	(45813)	
Boeing	DC9-50	C	III	2	93.5	28.8	133.5	59.1	60.9	19.4	122,000	135
					(28.50)	(8.78)	(40.70)	(18.00)	(18.56)	(5.90)	(55338)	
Bombardier	BD-100-1A10	C	II	2	63.8	20.0	68.8	26.3	27.8	12.8	38,850	124
					(19.5)	(6.1)	(21.0)	(8.0)	(8.5)	(3.9)	(17,622)	
Bombardier	CL-600-1A11 (600)	C	II	2	64.3	20.7	68.4	23.2	26.2	12.6	41,100 – 41,250 <sup>◊</sup>	133.25
					(19.6)	(6.3)	(20.9)	(7.1)	(8.1)	(3.8)	(18,648 – 18,711) <sup>◊</sup>	
Bombardier	CL-600-2A12 (601 Variant)	C	II	2	64.3	20.7	68.4	23.2	26.2	12.6	43,100 – 45,100 <sup>◊</sup>	135
					(19.6)	(6.3)	(20.9)	(7.1)	(8.1)	(3.8)	(19,550 – 20,457) <sup>◊</sup>	
Bombardier	CL-600-2B16 (601-3A Variant)	C	II	2	64.3	20.7	68.4	23.2	26.2	12.6	43,100 – 45,100 <sup>◊</sup>	135
					(19.6)	(6.3)	(20.9)	(7.1)	(8.1)	(3.8)	(19,550 – 20,457) <sup>◊</sup>	

<sup>◊</sup> Contact Bombardier for detailed information.

Manufacturer	Aircraft	AAC	ADG	TDG	Wing-span	Tail Height	Length	CMG	Wheel-base	MGW Outer to Outer	MTOW	V <sub>REF</sub> / Approach Speed
					ft (m)	ft (m)	ft (m)	ft (m)	ft (m)	ft (m)	lbs (kg)	kts
Bombardier	CL-600-2B16 (601-3R Variant)	C	II	2	64.3	20.7	68.4	23.2	26.2	12.6	45,100	135
					(19.6)	(6.3)	(20.9)	(7.1)	(8.1)	(3.8)	(20,457)	
Bombardier	CL-600-2B16 (604 Variant)	C	II	2	64.3	20.7	68.4	23.2	26.2	12.6	47,600 – 48,200 <sup>◊</sup>	132
					(19.6)	(6.3)	(20.9)	(7.1)	(8.1)	(3.8)	(21,591 – 21,863) <sup>◊</sup>	
Bombardier	CL-600-2B19 (Regional Jet Series 100, 440)	C - D <sup>◊</sup>	II	3	69.5	20.7	87.8	24.5	36.3	12.0	53,000	140.8 - 142.5 <sup>◊</sup>
					(21.2)	(6.3)	(26.8)	(7.5)	(11.1)	(3.6)	(24,041)	
Bombardier	CL-600-2C10 (Regional Jet Series 700, 701 and 702)	C	II	3	76.3	24.4	106.7	48.2	49.3	16.5	75,000	134.4
					(23.2)	(7.4)	(32.5)	(14.7)	(15.0)	(5.0)	(34,020)	
Bombardier	CL-600-2D15 (Regional Jet Series 705)	C	III	3	81.5	24.1	118.9	48.2	56.8	16.5	84,500	134.4
					(24.4)	(7.3)	(36.2)	(14.7)	(17.3)	(5.0)	(38,329)	
Bombardier	CL-600-2D24 (Regional Jet Series 900)	C	III	3	81.5	24.1	118.9	55.7	56.8	16.5	84,500	140.7
					(24.4)	(7.3)	(36.2)	(17.0)	(17.3)	(5.0)	(38,329)	
Bombardier	CL-600-2E25 (Regional Jet Series 1000)	C	III	3	85.8	24.4	128.6	60.7	61.8	16.5	91,800	139.9
					(26.2)	(7.4)	(39.2)	(18.5)	(18.8)	(5.0)	(41,640)	
Bombardier	CL-215-6B11 (CL-415 Variant) Restricted Category - Land Operation	A	III	3	93.8	29.8	65.0 – 66.58 <sup>◊</sup>	12.0	23.7	18.6	43,850	87
					(28.6)	(9.1)	(19.8 – 20.28 <sup>◊</sup> )	(3.7)	(7.2)	(5.7)	(19,890)	
Bombardier	CL-215-6B11 (CL-415 Variant) Utility Category - Land Operation	A	III	3	93.8	29.8	65.0 – 66.58 <sup>◊</sup>	12.0	23.7	18.6	41,000	87
					(28.6)	(9.1)	(19.8 – 20.28 <sup>◊</sup> )	(3.7)	(7.2)	(5.7)	(18,597)	
Bombardier	CL-215-6B11 (CL-215T Variant) Restricted Category - Land Operation	A	III	3	93.8	29.8	65.02 – 66.6 <sup>◊</sup>	12.0	23.7	18.6	43,500	87
					(28.6)	(9.1)	(19.8-20.28 <sup>◊</sup> )	(3.7)	(7.2)	(5.7)	(19,731)	



Manufacturer	Aircraft	AAC	ADG	TDG	Wing-span	Tail Height	Length	CMG	Wheel-base	MGW Outer to Outer	MTOW	V <sub>REF</sub> / Approach Speed
					ft (m)	ft (m)	ft (m)	ft (m)	ft (m)	ft (m)	lbs (kg)	kts
Bombardier	CL-215-6B11 (CL-215T Variant) Utility Category - Land Operation	A	III	3	93.8	29.8	65.0-66.58 <sup>◊</sup>	12.0	23.7	18.6	37,850	87
					(28.6)	(9.1)	(19.8-20.28 <sup>◊</sup> )	(3.7)	(7.2)	(5.7)	(17,168)	
Bombardier	CL-215-1A10 (CL-215) Restricted Category - Land Operation	A	III	3	93.8	29.5	65.0 – 66.43 <sup>◊</sup>	12.0	23.7	18.6	43,500	87
					(28.6)	(9.0)	(19.8 – 20.24 <sup>◊</sup> )	(3.7)	(7.2)	(5.7)	(19,731)	
Bombardier	CL-215-1A10 (CL-215) Utility Category - Land Operation	A	III	3	93.8	29.5	65.02– 66.45 <sup>◊</sup>	12.0	23.7	18.6	36,000	87
					(28.6)	(9.0)	(19.8 – 20.24 <sup>◊</sup> )	(3.7)	(7.2)	(5.7)	(16,329)	
Bombardier	CL-215-1A10 (CL-215) Modified with SB 215-124	A	III	3	93.8	29.5	65.0 – 66.43 <sup>◊</sup>	12.0	23.7	18.6	37,700	87
					(28.6)	(9.0)	(19.8 – 20.24 <sup>◊</sup> )	(3.7)	(7.2)	(5.7)	(17,100)	
Bombardier	BD-500-1A10 (CS100)	C	III	3	115.1	37.7	114.8	45.6	43.0	22.1	129,000	127
					(35.1)	(11.5)	(35.0)	(13.9)	(13.1)	(6.7)	(58,513)	
Bombardier	BD-500-1A11 (CS300)	C	III	3	115.1	37.6	127.0	52.6	50.0	22.1	144,000	133
					(35.1)	(11.5)	(38.7)	(16.0)	(15.2)	(6.7)	(65,317)	
Bombardier	DHC-8-101	B	III	4	85.0	24.5	73.0	22.6	26.1	28.0	33,000	92
					(25.9)	(7.5)	(22.3)	(6.9)	(8.0)	(8.5)	(14,970)	
Bombardier	DHC-8-102	B	III	4	85.0	24.5	73.0	22.6	26.1	28.0	34,500	92
					(25.9)	(7.5)	(22.3)	(6.9)	(8.0)	(8.5)	(15,649)	
Bombardier	DHC-8-103	B	III	4	85.0	24.5	73.0	22.6	26.1	28.0	34,500 – 35,200 <sup>◊</sup>	92
					(25.9)	(7.5)	(22.3)	(6.9)	(8.0)	(8.5)	(15,649 – 15,966) <sup>◊</sup>	
Bombardier	DHC-8-106	B	III	4	85.0	24.5	73.0	22.6	26.1	28.0	36,300	92
					(25.9)	(7.5)	(22.3)	(6.9)	(8.0)	(8.5)	(16,466)	
Bombardier	DHC-8-201	B	III	4	85.0	24.5	73.0	22.6	26.1	28.1	36,300	92
					(25.9)	(7.5)	(22.3)	(6.9)	(8.0)	(8.6)	(16,466)	
Bombardier	DHC-8-202	B	III	4	85.0	24.5	73.0	22.6	26.1	28.1	36,300	92
					(25.9)	(7.5)	(22.3)	(6.9)	(8.0)	(8.6)	(16,466)	
Bombardier	DHC-8-301	B	III	4	90.0	24.6	84.3	28.7	32.8	28.5	41,100	99 <sup>◊</sup>
					(27.4)	(7.5)	(25.7)	(8.7)	(10.0)	(8.7)	(18,648)	
Bombardier	DHC-8-311	B	III	4	90.0	24.6	84.3	28.7	32.8	28.5	41,100 – 43,000 <sup>◊</sup>	99 <sup>◊</sup>
					(27.4)	(7.5)	(25.7)	(8.7)	(10.0)	(8.7)	(18,648 – 19,505) <sup>◊</sup>	

Manufacturer	Aircraft	AAC	ADG	TDG	Wing-span	Tail Height	Length	CMG	Wheel-base	MGW Outer to Outer	MTOW	V <sub>REF</sub> / Approach Speed
					ft (m)	ft (m)	ft (m)	ft (m)	ft (m)	ft (m)	lbs (kg)	kts
Bombardier	DHC-8-314	B	III	4	90.0	24.6	84.3	28.7	32.8	28.5	41,100 – 43,000 <sup>◊</sup>	99 <sup>◊</sup>
					(27.4)	(7.5)	(25.7)	(8.7)	(10.0)	(8.7)	(18,648 – 19,505) <sup>◊</sup>	
Bombardier	DHC-8-315	B	III	4	90.0	24.6	84.3	28.7	32.8	28.5	41,100 – 43,000 <sup>◊</sup>	99 <sup>◊</sup>
					(27.4)	(7.5)	(25.7)	(8.7)	(10.0)	(8.7)	(18,648 – 19,505) <sup>◊</sup>	
Bombardier	DHC-8-400	B	III	--	93.3	27.5	107.8	32.0	45.8	31.2	61,700 – 65,200 <sup>◊</sup>	118 – 120 <sup>◊</sup>
					(28.4)	(8.4)	(32.8)	(9.8)	(14.0)	(9.5)	(27,987 – 29,574) <sup>◊</sup>	
Bombardier	DHC-8-401	B	III	--	93.3	27.5	107.8	32.0	45.8	31.2	61,700 – 65,200 <sup>◊</sup>	118 – 120 <sup>◊</sup>
					(28.4)	(8.4)	(32.8)	(9.8)	(14.0)	(9.5)	(27,987 – 29,574) <sup>◊</sup>	
Bombardier	DHC-8-402	B	III	--	93.3	27.5	107.8	32.0	45.8	31.2	61,700 – 65,200 <sup>◊</sup>	118 – 120 <sup>◊</sup>
					(28.4)	(8.4)	(32.8)	(9.8)	(14.0)	(9.5)	(27,987 – 29,574) <sup>◊</sup>	
Bombardier	BD-700-1A10 (Global 5000)	C	III	3	94.0	25.5	99.4	41.9	42.4	16.0	99,500	129
					(28.7)	(7.8)	(30.3)	(12.8)	(12.9)	(4.9)	(45,132)	
Bombardier	BD-700-1A11 (Global 6000)	C	III	3	94.0	25.5	96.8	39.2	39.8	16.0	92,500	129
					(28.7)	(7.8)	(29.5)	(11.9)	(12.1)	(4.9)	(41,957)	
British Aerospace	BAE-146-200	C	III	2	86.4	28.2	93.7	37	37	20	93,035	125
					(26)	(9)	(29)	(11.5)	(11.5)	(6)	(42201)	
Cessna	Citation Mustang		I	2	43.2	13.4	40.6	10 <sup>†</sup>	14.3	17 <sup>†</sup>	8,645	
					(13.2)	(4.1)	(12.4)	(3.0) <sup>†</sup>	(4.4)		(3921.4)	
Cessna	Citation CJ2+	B	II	2	49.8	14	47.7	14 <sup>†</sup>	17.8	17 <sup>†</sup>	12,500	115
					(15.2)	(4.3)	(14.5)	(4.3) <sup>†</sup>	(5.4)		(5670)	
Cessna	Citation CJ3	B	II	2	53.3	15.2	51.2	16 <sup>†</sup>	20	17 <sup>†</sup>	13,870	130
					(16.2)	(4.6)	(15.6)	(4.9) <sup>†</sup>	(6.1)		(6291)	
Cessna	Citation CJ4		II	1B	50.8	15.3	53.3	17 <sup>†</sup>	21.2	13.5 <sup>†</sup>	16,950	
					(15.5)	(4.7)	(16.3)	(5.2) <sup>†</sup>	(6.5)		(7689)	
Cessna	Citation XLS+		II	2	56.3	17.2	52.5	18 <sup>†</sup>	21.9	16 <sup>†</sup>	20,200	
					(17.2)	(5.24)	(16)	(5.5) <sup>†</sup>	(6.7)		(9163)	
Cessna	Citation Sovereign	B	II	1B	63.3	20.3	63.5	25 <sup>†</sup>	27.8	12 <sup>†</sup>	30,300	
					(19.3)	(6.2)	(19.4)	(7.6) <sup>†</sup>	(8.5)		(13744)	
Cessna	Citation X		II	1B	63.9	19.3	72.3	27 <sup>†</sup>	29.9	13 <sup>†</sup>	36,100	
					(19.5)	(5.9)	(22.0)	(8.2) <sup>†</sup>	(9.1)		(16375)	
Cessna	Citation Ten	C	II	1B	69.2	19.3	73.6	28 <sup>†</sup>		13 <sup>†</sup>	36,600	130
					(21.1)	(5.9)	(22.4)	(8.6) <sup>†</sup>			(16602)	

<sup>†</sup> Estimated

Manufacturer	Aircraft	AAC	ADG	TDG	Wing-span	Tail Height	Length	CMG	Wheel-base	MGW Outer to Outer	MTOW	V <sub>REF</sub> / Approach Speed
					ft (m)	ft (m)	ft (m)	ft (m)	ft (m)	ft (m)	lbs (kg)	kts
Cessna	Centurion	A	I	1A	36.7	9.8	28.2	6	6	10	4,012	75
					(11)	(3)	(9)	(2)	(2)	(3)	(1223)	
Cessna	Cessna Stationair6	B	I	1A	35.8	9.8	28.2	7	7	9	3,638	92
					(11)	(3)	(9)	(2)	(2)	(3)	(1650)	
Cessna	Cessna 182 Skylane	B	I	1A	36.1	9.2	28.2	6	6	9	2,800	92
					(11)	(3)	(9)	(2)	(2)	(3)	(1270)	
DeHavilland Canada	DHC-8-300 Dash 8	A	III	3	89.9	24.6	84.3	33	33	27	41,099	90
					(27)	(7)	(26)	(10)	(10)	(8)	(18642)	
DeHavilland Canada	DHC-7 Dash 7	A	III	3	93.2	26.2	80.7	28	28	26	47,003	83
					(28)	(8)	(25)	(8.5)	(8.5)	(8)	(21321)	
DeHavilland Canada	DHC-8-100 Dash 8	B	III	3	85.0	24.6	73.2	33	33	27	34,502	100
					(26)	(7)	(22)	(10)	(10)	(8)	(15650)	
Douglas	DC-8-50	C	IV		142.4	43.6	150.7			260	325,000	137
					(43.4)	(13.3)	(45.9)			(7.7)	(147418)	
Douglas	DC-8-60	C	IV		142.4	42.3	187.3			24.7	349,874	137
					(43)	(13)	(57)			(7.5)	(158703)	
Embraer	EMB-110 Bandeirante	B	II	2	50.2	16.1	46.6	17	17	17	13,007	92
					(15)	(5)	(14)	(5)	(5)	(5)	(5900)	
Embraer	EMB-120 Brasilia	B	II	3	65.0	21.0	65.6	23	23	24	26,455	120
					(20)	(6)	(20)	(7)	(7)	(7)	(12000)	
Embraer	170	C	III		85.3	32.3	98.1		34.8		79,344	124
					(26.0)	(10.0)	(29.90)		(10.6)		(35990)	
Embraer	175		III		85.3	31.9	103.9				82,673	
					(26.0)	(9.73)	(31.68)				(37500)	
Embraer	190	C	III		94.3	34.7	118.9		45.3		105,359	124
					(28.72)	(10.57)	(36.24)		(13.8)		(47790)	
Embraer	195		III		94.3	34.6	126.8		48		107,564	
					(28.72)	(10.55)	(38.65)		(14.6)		(48790)	
Embraer	ERJ135	C	II		65.8	22.2	86.4	41.8	41.8		41,887	130
					(20.04)	(6.76)	(26.33)	(12.7)	(12.7)		(19000)	
Embraer	ERJ140		II		65.8	22.2	93.3	44.3	44.3		44,312	
					(20.04)	(6.76)	(28.45)	(13.5)	(13.5)		(20100)	
Embraer	ERJ145	C	II		65.8	22.2	98	47.4	47.4		48,501	135
					(20.04)	(6.76)	(29.87)	(14.4)	(14.4)		(22000)	
Embraer	ERJ145XR		II		65.8	22.2	98	47.4	47.4		53131	
					(20.04)	(6.76)	(29.87)	(14.4)	(14.4)		(24100)	
Fokker	F-27 Friendship	B	III	3	95.1	27.9	75.8	29	29	27	44,996	120
					(29)	(9)	(23)	(9)	(9)	(8)	(20410)	
Fokker	F-28 Fellowship	C	III	2	88.8	27.9	89.9	30	30	20	72,995	125
					(27)	(9)	(27)	(9)	(9)	(6)	(33111)	
Gulfstream	G150		II		55.6	19.1	56.8	21	21		26,100	
					(16.94)	(5.82)	(17.30)	(6.4)	(6.4)		(11839)	
Gulfstream	G280		II		63	21.3	66.8				39,600	
					(19.2)	(6.5)	(20.37)				(17962)	
Gulfstream	G350	C	II		77.8	25.2	89.3				70,900	140
					(23.72)	(7.67)	(27.23)				(32160)	
Gulfstream	G450		II		77.8	25.2	89.3				74,600	

Manufacturer	Aircraft	AAC	ADG	TDG	Wing-span	Tail Height	Length	CMG	Wheel-base	MGW Outer to Outer	MTOW	V <sub>REF</sub> / Approach Speed
					ft (m)	ft (m)	ft (m)	ft (m)	ft (m)	ft (m)	lbs (kg)	kts
					(23.72)	(7.67)	(27.23)				(33838)	
Gulfstream	G500	C	III		93.5	25.8	96.4	45	45		85,100	140
					(28.50)	(7.87)	(29.39)	(13.7)	(13.7)		(38601)	
Gulfstream	G550	C	III		93.5	25.8	96.4	45	45		91,000	140
					(28.50)	(7.87)	(29.39)	(13.7)	(13.7)		(41277)	
Gulfstream	G650		III		99.7	25.7	99.8				99,600	
					(30.36)	(7.82)	(30.41)				(45178)	
Learjet	Learjet 24	C	I	1A	35.1	12.3	43.0	17	17	10	13,001	128
					(11)	(4)	(13)	(5)	(5)	(3)	(5897)	
Learjet	Learjet 25	C	I	1A	35.4	12.1	47.6	17	17	10	14,991	137
					(11)	(4)	(15)	(5)	(5)	(3)	(6800)	
McDonnell Douglas	MD-11	D	IV	6	170.5	58.8	202.2	101.7	80.8	41.3	630,500	153
					(52.0)	(17.9)	(61.6)	(40.00)	(24.6)	(12.57)	(285995)	
Piper	PA-28R Cherokee Arrow	A	I	1A	29.9	7.9	24.3	8	8	12	2,491	70
					(9)	(2)	(7)	(2)	(2)	(3.5)	(1130)	
Piper	PA-28-140 Cherokee	A	I	1A	35.1	7.2	24.0	7	7	11	2,425	65
					(11)	(2)	(7)	(2)	(2)	(3)	(1100)	

### Appendix 2. Wind Analysis

#### A2-1. Objective.

This appendix provides guidance on the assembly and analysis of wind data to determine runway orientation. It also provides guidance on analyzing the operational impact of winds on existing runways.

**a.** Wind is a key factor influencing runway orientation and the number of runways. Ideally, a runway should be aligned with the prevailing wind. Wind conditions affect all aircraft in varying degrees. Generally, the smaller the aircraft, the more it is affected by wind, particularly crosswind components (Figure A2-1) which are often a contributing factor in small aircraft accidents.

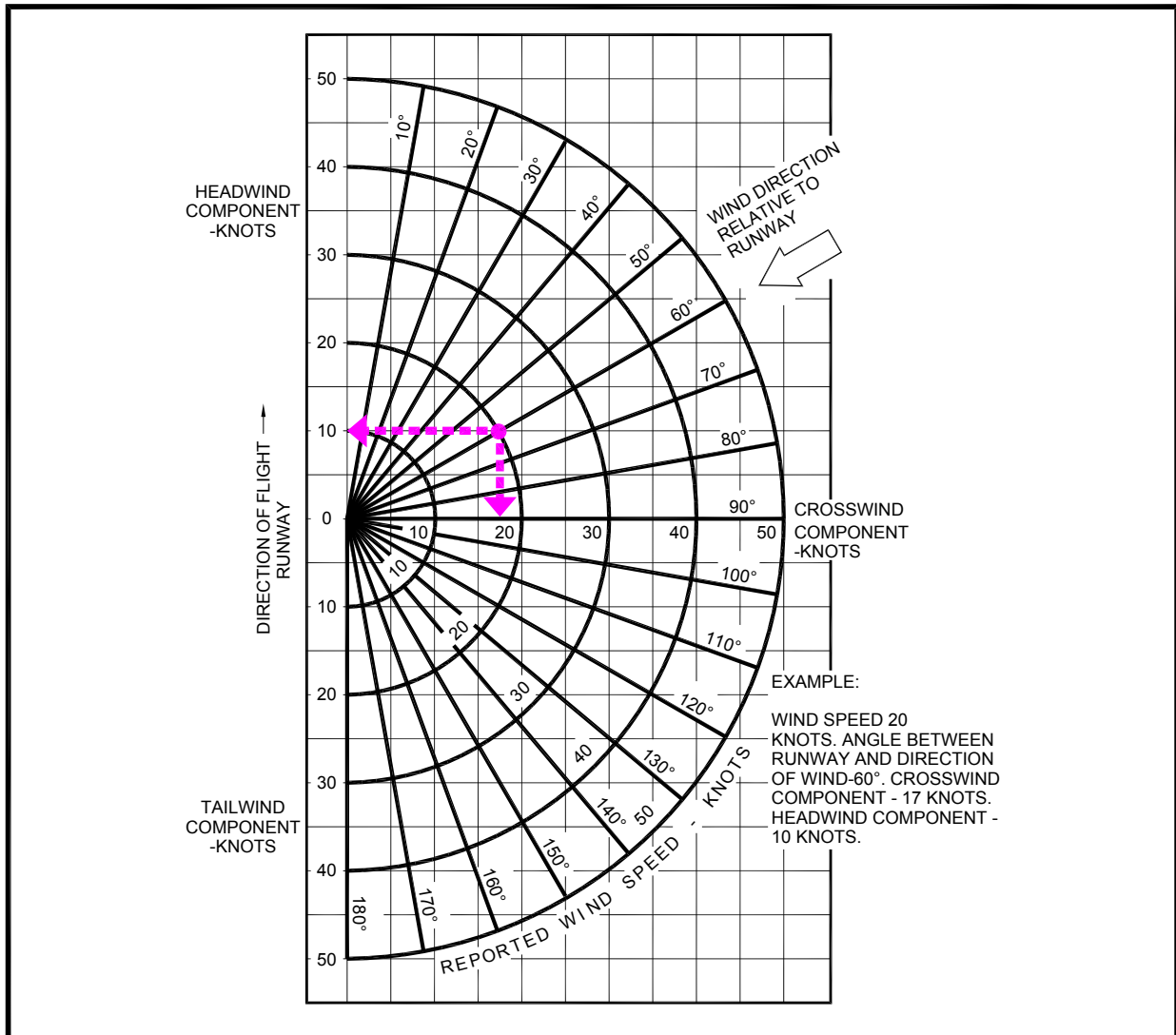


Figure A2-1. Wind vector diagram

**b.** Airport planners and designers should make an accurate analysis of wind to determine the orientation and number of runways at an airport. Construction of two runways may be necessary to achieve the desired 95.0 percent wind coverage. The correct application of the results of the wind data analysis will add substantially to the safety and utility of the airport.

### **A2-2. Crosswinds.**

The crosswind component of wind direction and velocity is the resultant vector which acts at a right angle to the runway. It is equal to the wind velocity multiplied by the trigonometric sine of the angle between the wind direction and the runway direction. The wind vector triangles may be solved graphically as shown in Figure A2-1. From this diagram, one can also determine the headwind and tailwind component for combinations of wind velocities and directions.

### **A2-3. Allowable crosswind components.**

When a runway orientation provides less than 95.0 percent wind coverage for the aircraft which are forecast to use the airport on a regular basis, a crosswind runway may be required. The allowable crosswind component(s) for each Runway Design Code (RDC) which are used to determine the percentage of wind coverage are shown in Table 3-1.

### **A2-4. Coverage and orientation of runways.**

The most advantageous runway orientation based on wind is the one which provides the greatest wind coverage with the minimum crosswind components. Wind coverage is the percent of time crosswind components are below an acceptable velocity. The desirable wind coverage for an airport is 95 percent, based on the total numbers of weather observations during the record period, typically 10 consecutive years. The data collection should be undertaken with an understanding of the objective; i.e., to attain 95 percent utility of the runway and/or airport. At many airports, aircraft operations decline after dark, and it may be desirable to analyze the wind data on less than a 24-hour observation period. At airports where operations are predominantly seasonal, you should consider the wind data for the predominant-use period. At locations where provision of a crosswind runway is impractical due to severe terrain constraints you may need to consider increasing operational tolerance to crosswinds by upgrading the airport layout to the next higher RDC.

### **A2-5. Assembling wind data.**

The latest and most reliable wind information should always be used to carry out a wind analysis. A record which covers the last 10 consecutive years of wind observations is recommended. Records of lesser duration may be acceptable on a case-by-case basis, but this should be discussed with and agreed to by the FAA Airports Region/District Office prior to proceeding. In some instances, it may be highly desirable to obtain and assemble wind information for periods of particular significance; e.g., seasonal variations, instrument weather conditions, daytime versus nighttime, and regularly occurring gusts.

**A2-6. Data source.**

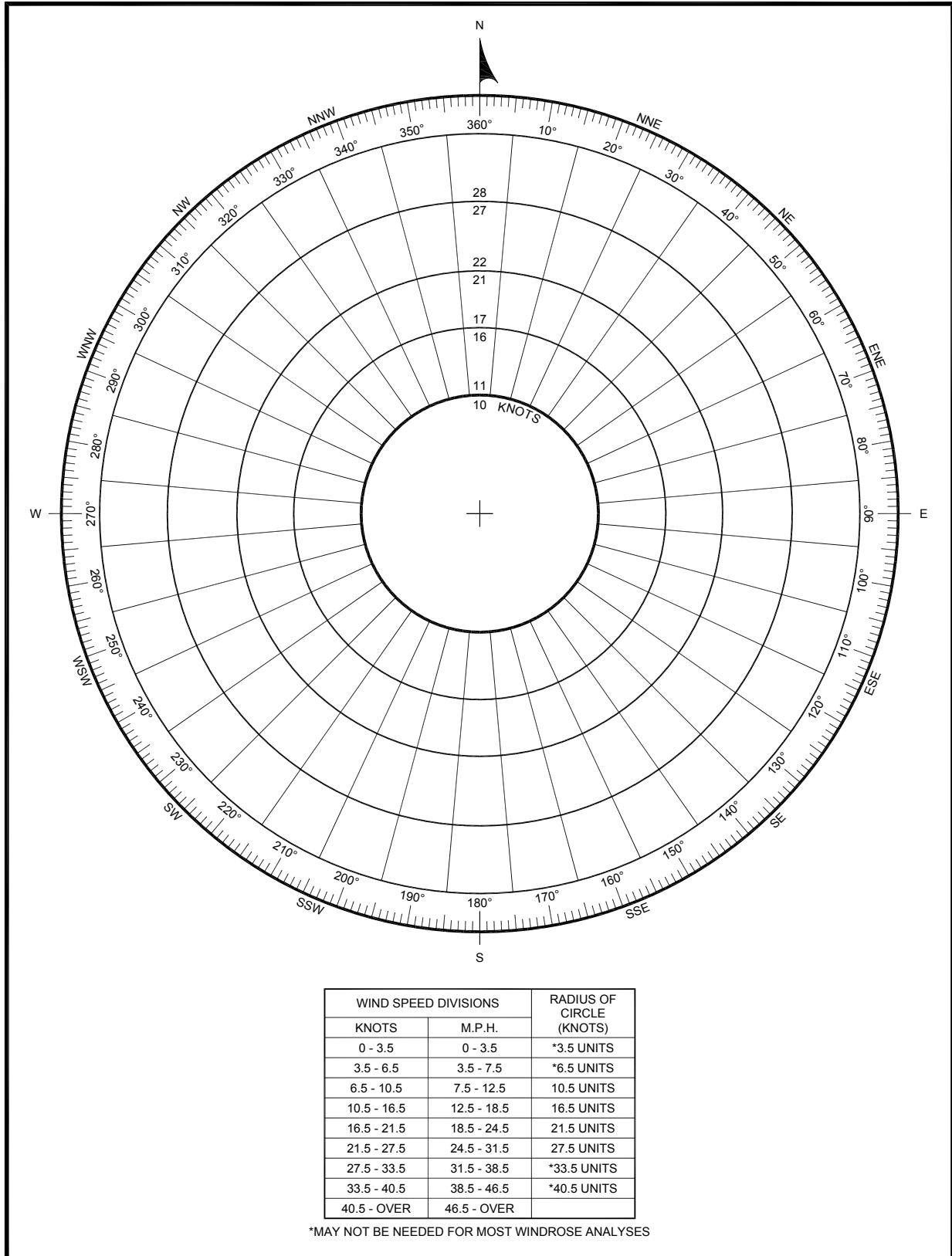
The best source of wind information is the National Oceanic and Atmospheric Administration, National Climatic Data Center (NCDC). The NCDC is located at:

Climate Services Branch  
National Climatic Data Center  
151 Patton Avenue  
Asheville, North Carolina 28801-5001  
Tel: 828-271-4800 / Fax: 828-271-4876  
Public Web Address: [www.ncdc.noaa.gov](http://www.ncdc.noaa.gov)

The NCDC no longer provides wind data in the FAA format. However, the hourly data is now available free of charge at the following website: [www1.ncdc.noaa.gov/pub/data/noaa/](http://www1.ncdc.noaa.gov/pub/data/noaa/). Data will require conversion to the FAA format to use in the FAA windrose program. You will need to determine the ceiling, visibility, and whether you want VMC, IMC, all-weather or all wind data for your location. The wind summary for the airport site should be formatted with the standard 36 wind sectors (the NCDC standard for noting wind directions) and the wind speed groupings shown in [Figure A2-2](#). An existing wind summary of recent vintage may be acceptable for analysis purposes if these standard wind direction and speed groupings are used. [Figure A2-3](#) is an example of a typical wind summary.

**a. Data not available.** In those instances when NCDC data are not available for the site, it may be possible to develop composite wind data using wind information obtained from two or more nearby recording stations. However, exercise caution because the composite data may have limited value if there are significant changes in the topography (such as hills/mountains, bodies of water, ground cover, etc.) between the sites. Limited records should be augmented with personal observations (wind-bent trees, interviews with the local populace, etc.) to ascertain if a discernible wind pattern can be established.

**b.** When there is a question on the reliability of or lack of wind data, it may be necessary to obtain onsite wind observations. If the decision is made to obtain onsite wind data, the recommended monitoring period should be at least one year to produce reliable data. One year will usually be adequate to determine the daily wind fluctuations and seasonal changes for the site. Airport development should not proceed until adequate wind data have been acquired.



**Figure A2-2. Blank windrose showing direction and divisions**



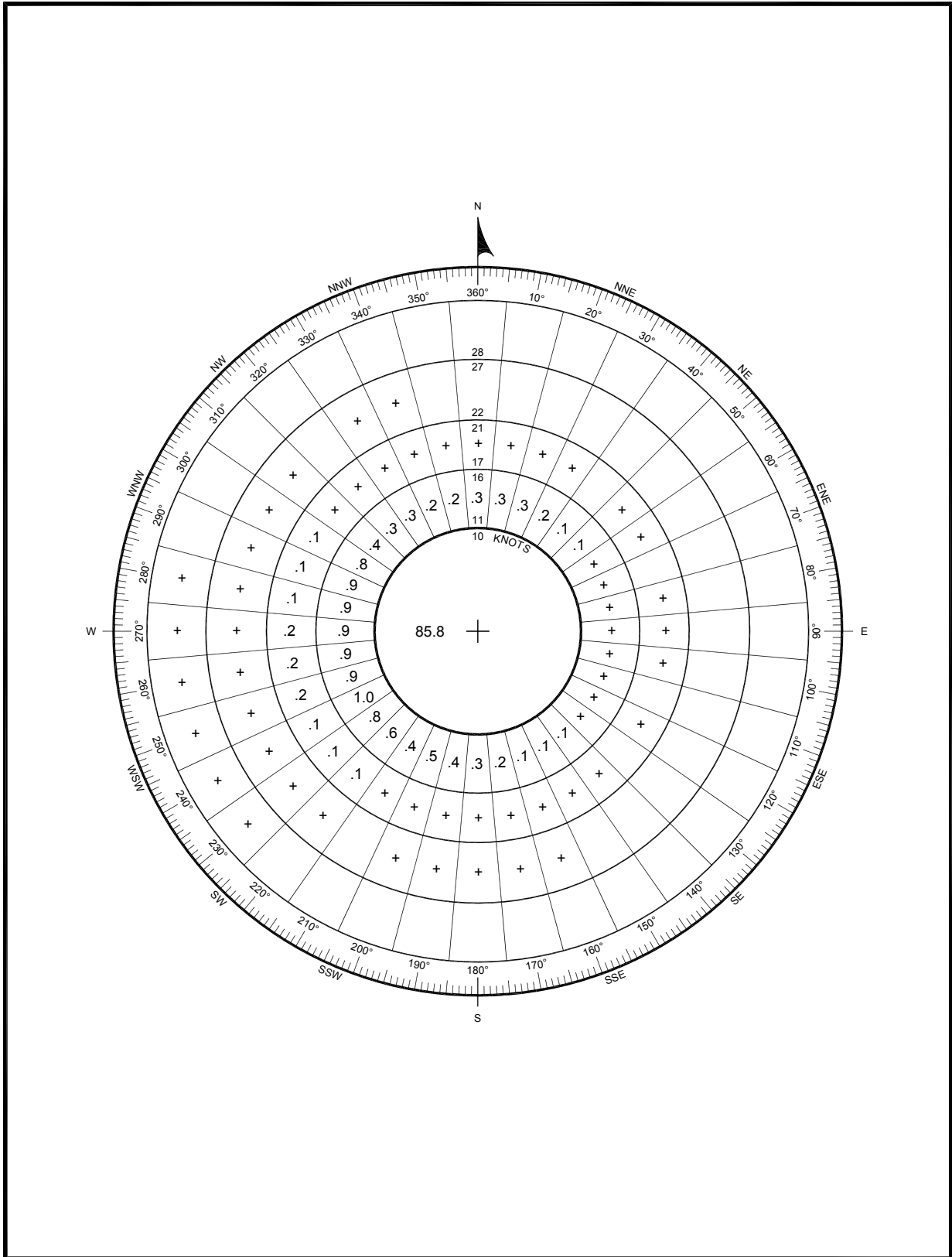


Figure A2-3. Completed windrose using Figure A2-1 data

## **A2-7. Analyzing wind data.**

The most common wind analysis procedure uses a windrose which is a scaled graphical presentation of the wind information.

**a. Drawing the windrose.** The standard windrose (Figure A2-2) is a series of concentric circles cut by radial lines. The perimeter of each concentric circle represents the division between successive wind speed groupings (Figure A2-2). Radial lines are drawn dividing the windrose into 36 wind sectors so that the area of each sector is centered on the direction of the reported wind.

**b. Plotting wind data.** Each segment of the windrose represents a wind direction and speed grouping corresponding to the wind direction and speed grouping on the NCDC summary. The recorded directions and speeds of the wind summary are converted to a percentage of the total recorded observations. Computations are rounded to the nearest one-tenth of 1 percent and entered in the appropriate segment of the windrose. Figure A2-4 illustrates a completed windrose analysis based on data from Figure A2-3. Plus (+) symbols are used to indicate direction and speed combinations which occur less than one-tenth of 1 percent of the time.

**c. Crosswind template.** A transparent crosswind template is a useful aid in carrying out the windrose analysis (Figure A2-4). The template is essentially a series of three parallel lines drawn to the same scale as the windrose. The allowable crosswind component for the runway as determined by the RDC establishes the physical distance between the outer parallel lines and the centerline. When analyzing the wind coverage for a runway orientation, the design crosswind limit lines can be drawn directly on the windrose.

**Note:** NCDC wind directions are recorded on the basis of true north. The magnetic runway headings will be determined based on the magnetic declination for the site.

**d. Analysis procedure.** The purpose of the analysis is to determine the runway orientation which provides the greatest wind coverage within the allowable crosswind component limits. This can be readily estimated by rotating the crosswind template about the windrose center point until the sum of the individual segment percentages appearing between the outer “crosswind limit” lines is maximized. It is accepted practice to total the percentages of the segments appearing outside the limit lines and to subtract this number from 100. For analyses purposes, winds are assumed to be uniformly distributed throughout each of the individual segments. Figure A2-3 and Figure A2-4 illustrate the analysis procedure as it would be used in determining the wind coverage for a runway, oriented 90-270 degrees, intended to serve all types of aircraft. The wind information is from Figure A2-3. Several trial orientations may be needed to determine the orientation which maximizes wind coverage.

**Table A2-1. Standard wind analysis results for ALL\_WEATHER**

TITLE: Anytown, USA										
RUNWAY ORIENTATION:		270 DEGREE								
CROSSWIND COMPONENT:		13 KNOTS								
TAILWIND COMPONENT:		60 KNOTS								
WIND COVERAGE:		97.79%								
HOURLY OBSERVATIONS OF WIND SPEED (KNOTS)										
DIRECTION	0-3	4-6	7-10	11-16	17-21	22-27	28-33	34-40	> 41	TOTAL
10°	174	652	586	247	6	0	0	0	0	1665
20°	213	816	698	221	7	0	0	0	0	1955
30°	235	894	656	158	4	0	0	0	2	1949
40°	167	806	559	88	0	0	0	0	0	1620
50°	182	809	345	44	1	0	0	0	0	1381
60°	199	753	332	30	5	0	0	0	0	1319
70°	158	550	187	20	0	0	0	0	1	916
80°	134	453	194	22	1	0	0	0	0	804
90°	145	373	169	16	2	0	0	0	0	705
100°	103	321	115	19	1	0	0	0	2	561
110°	92	293	138	25	0	0	0	0	0	548
120°	90	283	207	33	3	0	0	0	0	616
130°	93	279	188	28	0	0	0	0	0	588
140°	65	246	195	55	2	0	0	0	1	564
150°	64	213	194	42	4	0	0	0	0	517
160°	61	236	201	105	16	1	0	0	1	621
170°	80	254	306	140	10	2	0	0	1	793
180°	88	372	485	194	25	2	0	0	0	1166
190°	125	499	608	278	17	2	0	0	0	1529
200°	184	717	700	370	27	2	0	0	0	2000
210°	264	950	725	331	26	0	0	0	2	2298
220°	321	1419	1030	445	40	5	0	0	0	3260
230°	396	1658	1355	630	97	9	1	0	0	4146
240°	415	1600	1465	782	83	13	2	0	1	4361
250°	323	1166	1093	730	119	33	5	0	0	3469
260°	311	979	918	715	139	23	4	0	0	3089
270°	248	760	810	660	143	28	3	0	0	2652
280°	226	625	815	666	105	14	2	0	0	2453
290°	162	572	865	710	98	11	0	0	0	2418
300°	130	470	788	590	68	5	0	0	0	2051
310°	82	394	659	325	31	1	0	0	0	1492
320°	97	302	485	246	15	0	0	0	0	1145
330°	66	281	450	196	6	1	0	0	0	1000
340°	85	265	369	151	4	1	0	0	0	875
350°	102	314	323	152	12	0	0	0	0	903
360°	140	394	457	223	16	0	0	0	0	1230
Calm	18705									18705
TOTAL	24725	21968	19670	9687	1133	153	17	0	11	77364
SOURCE: Anytown, USA ANNUAL PERIOD RECORD 1995-2004										
REFERENCE: Appendix 1 of AC 150/5300-13, Airport Design, including Changes 1 through 18.										

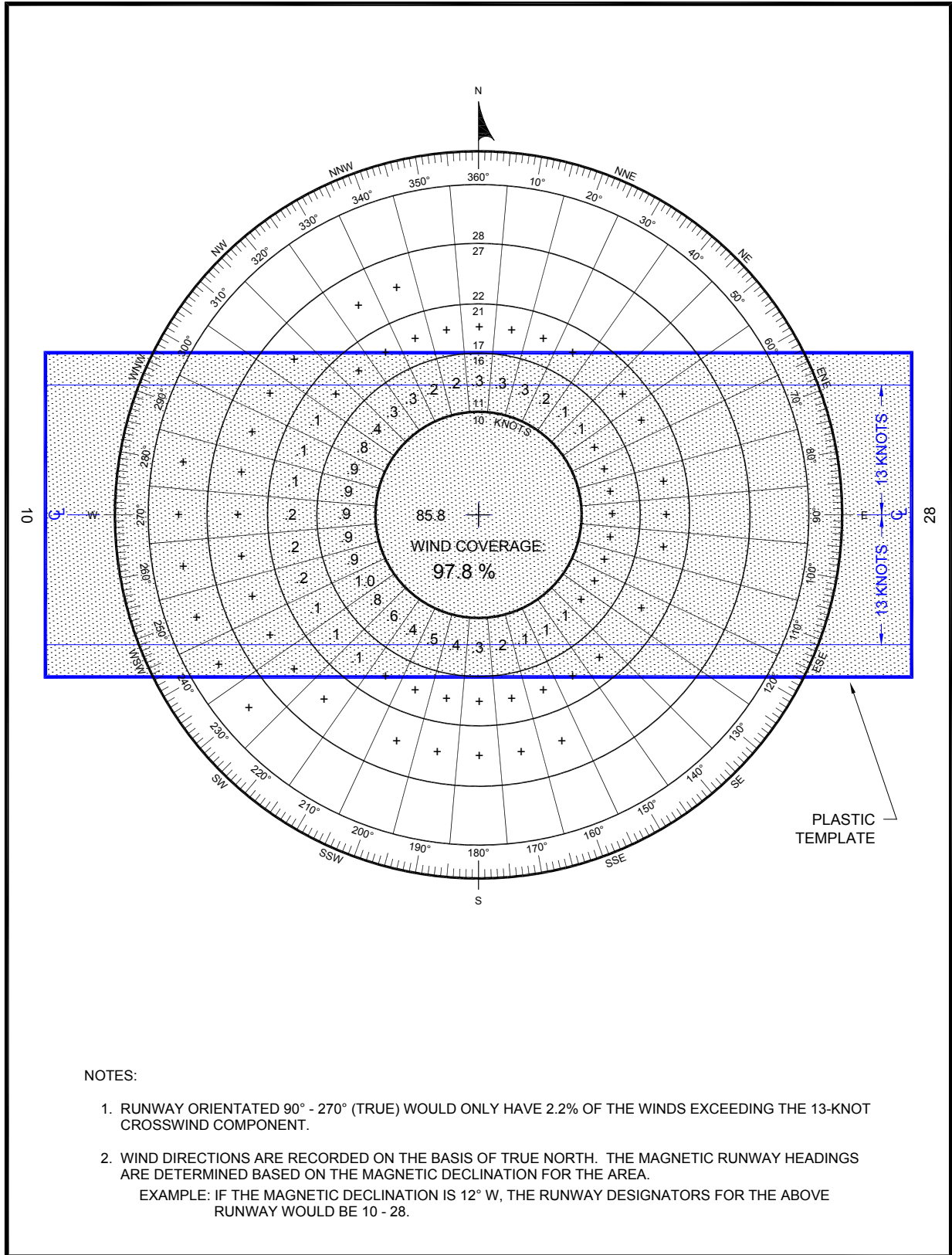


Figure A2-4. Windrose analysis

**A2-8. Conclusions.**

The example wind analysis shows that the optimum wind coverage possible with a single runway and a 13-knot crosswind component is 97.8 percent. If the analysis had shown that it was not possible to obtain at least 95.0 percent wind coverage with a single runway, then consideration should be given to provide an additional (crosswind) runway oriented to bring the combined wind coverage of the two runways to at least 95.0 percent.

**A2-9. Assumptions.**

The analysis procedures assume that winds are uniformly distributed over the area represented by each segment of the windrose. The larger the area, the less accurate is this assumption. Calculations made using nonstandard windrose directions or speeds result in a derivation of wind coverage (and its associated justification for a crosswind runway) which is questionable.

**A2-10. Automated wind analysis tools.**

Wind analysis is typically done using computer programs. Wind analysis tools are available on the FAA Airport Surveying – Geographic Information System (GIS) Program website: <https://airports-gis.faa.gov/public/index.html>.

**Page intentionally left blank.**

### Appendix 3. The Effects and Treatment of Jet Blast

#### A3-1. Introduction.

The forces of jet blast (jet exhaust) produce very high wind velocities and temperatures. Jet blast is capable of causing bodily injury to personnel; damage to airport equipment and facilities; and/or airfield pavement and erosion of unprotected soil along the edge of pavements. This appendix suggests means to minimize the effects of jet blast.

#### A3-2. Jet blast effects.

Jet blast affects all operational areas of the airport. In terminal, maintenance, and cargo areas, personnel safety is the primary consideration. Velocities greater than 30 mph (48 km/hr) can cause loose objects on the pavement to become airborne with the capability of causing injury to personnel, structures and equipment at considerable distances behind the aircraft. Sudden gusts averaging more than 20 mph (31 km/hr) may be more dangerous than continuous velocities of the same magnitude when striking moving vehicles or aircraft. Velocities of this magnitude can occur over 2,000 feet (610 m) to the rear of some aircraft when their engines are operating at takeoff thrust.

**a. Jet blast pressures.** Jet exhaust velocities are irregular and turbulent. The vibrations they induce over small areas should be considered in designing a building or structure which will be subjected to jet blast. Over areas of 10 to 15 ft<sup>2</sup> (1.0 to 1.4 m<sup>2</sup>), the velocities may be assumed to be periodic with peaks occurring at 2 to 6 times per second. These peaks are not continuous laterally or vertically. The following equation can be used to compute the pressure produced on a surface perpendicular to the exhaust stream:

$$P = 0.00256 V^2$$

where:

P = pressure (lbs/ft<sup>2</sup>)

V = velocity (mi/hr)

or

$$P = 0.04733 V^2$$

where:

P = pressure (pascals)

V = velocity (km/hr)

**b. Blast Velocity Distances.** The drag and uplift forces produced by jet engines are capable of moving large boulders. A jet engine operating at maximum thrust is capable of lifting a 2-foot (0.6 m) boulder located 35 feet (10.7 m) behind the aircraft. Forces that are capable of causing severe erosion decrease rapidly with distance so that beyond 1200 feet (366 m) behind some aircraft, only sand and cohesionless soils are affected.

#### A3-3. Jet engine exhaust velocity and temperature.

Aircraft manufacturers provide information on the exhaust velocities and temperatures for their respective aircraft and engine combinations. Typically, contours are provided for ground idle, breakaway (typical taxiing condition), and maximum takeoff power conditions under specific conditions (sea level, static airplane, zero wind, standard day conditions). This information can be found in the airport planning guides and/or airplane characteristics which are available on the aircraft manufacturer websites. Data on lateral and vertical velocity contours, as well as site specific blast loads on structures, may be obtained from the engine manufacturers.

#### **A3-4. Blast fences.**

Properly designed blast fences should substantially reduce or eliminate the damaging effects of jet blast, as well as the related fumes and noise which accompany jet engine operation. Blast fences are permissible near apron areas to protect personnel, equipment, or facilities from the jet blast of aircraft moving along taxiways and/or into or out of parking positions. In addition, blast fences may be necessary near runway ends, run-up pads, etc., to shield airport pedestrian and/or vehicular traffic, as well as to shield those areas adjacent to the airport boundary, but off-airport property which has pedestrian and/or vehicular traffic.

**a. Location.** Generally, the closer the fence is to the source of blast, the better it performs, provided that the centerline of the exhaust stream falls below the top of the fence. To the extent practicable, blast fences should be located outside of the full-dimension Runway Safety Area (RSA) and Runway Object Free Area (ROFA). When it is not practicable to locate the blast fence beyond the full-dimension RSA/ROFA, the RSA/ROFA will require additional measures such as an Engineered Materials Arresting System (EMAS) to comply with the standard RSA criteria.

**b. Design.** The selection of the design of the blast fence will be influenced by a number of things including the location, purpose, aircraft fleet, height, etc. Several types of blast fence design are readily available from various manufacturers. Blast fences located inside the runway free object area (ROFA) must be frangible in accordance with the requirements in AC 150/5220-23.

**c. Other types of blast protection.** Although blast fences are the most effective means of blast protection, other methods may achieve satisfactory results. Any secured surface, whether natural or manmade, located between the jet engine and the area to be protected will afford some measure of blast protection.

#### **A3-5. Shoulders and blast pads.**

Unprotected soils adjacent to runways and taxiways are susceptible to erosion due to jet blast. A dense, well-rooted turf cover can prevent erosion and support the occasional passage of aircraft, maintenance equipment, or emergency equipment under dry conditions. Paved shoulders are required for runways, taxiways, taxilanes, and aprons accommodating Airplane Design Group (ADG) IV and higher aircraft, and are recommended for taxiways, taxilanes and aprons accommodating ADG-III aircraft. Turf, aggregate-turf, soil cement, lime or bituminous stabilized soil are recommended adjacent to paved surfaces accommodating ADG-I and II aircraft. In addition to providing protection from jet blast, shoulders must be capable of safely supporting the occasional passage of the most demanding aircraft as well as emergency and maintenance vehicles under dry conditions.

**a. Shoulder and blast pad dimensions.** Full length paved shoulders are required for runway(s) and taxiway(s) that accommodate ADG-IV and higher aircraft. Full length paved shoulders are recommended for runway(s) and taxiway(s) that accommodate ADG-III aircraft. Blast pads at runway ends should extend across the full width of the runway plus the shoulders. Interactive Table 3-5 specifies the standard blast pad dimensions and runway shoulder



widths. Table 4-2 specifies the standard taxiway shoulder widths. Increases to these standard dimensions are permissible for unusual local conditions, but will require a modification to standards.

**b. Pavement strength.** Shoulder and blast pad pavements need to support the occasional passage of the most demanding aircraft as well as maintenance and emergency response vehicles. A pavement design procedure for shoulders and blast pads using the current FAARFIELD design software is provided in AC 150/5320-6. Additionally, the “Pavement Design for Airport Shoulders” chapter of AC 150/5320-6 provides direction on pavement layer minimum thickness requirements, material specification requirements, and guidance for shoulders in areas susceptible to frost heave.

**c. Drainage.** Surface drainage should be maintained and/or improved in the shoulder and blast pad areas. Where a paved shoulder or blast pad abuts the runway, the joint should be flush. Minimum transverse grades are specified in Chapter 3 for runways, Chapter 4 for taxiways and Chapter 5 for aprons. For runway blast pads, the longitudinal and transverse grades of the respective safety area will apply. A 1.5 inch (38 mm) drop should be provided between the edge of paved shoulders and blast pads and unpaved surfaces to enhance drainage and to prevent fine graded debris from accumulating on the pavement. Base and subbase courses must be of sufficient depth to maintain the drainage properties of granular base or subbase courses under the runway, taxiway, or apron pavement. AC 150/5320-5 contains guidance and recommendations on the design of subsurface pavement drainage systems.

**d. Marking.** AC 150/5340-1 provides guidance for marking shoulders and blast pads.

### **A3-6. Aircraft parking layout and jet blast effect(s).**

**a. General.** The location of aircraft parking areas requires careful attention with respect to jet blast effect(s). Whether the aircraft parking area is at the terminal gate, off-gate parking (“hardstands”) or a typical apron parking area, the impact to adjacent personnel, aircraft, taxiways/taxilanes, service roads, vehicles, and other objects must be considered in selecting the location, layout and operation of these area(s). Special emphasis is required when light general aviation aircraft and commuter aircraft are present. Passenger boarding/deplaning on an apron area poses additional risk from jet blast.

**b. Aircraft parking layout methodology.** The following methodology is recommended when siting aircraft parking locations:

(1) Select the design aircraft from the jet blast contours (velocity and distance) provided by the aircraft/engine manufacturer’s jet blast data.

(2) Apply the recommended jet exhaust velocity exposure limitation(s) in paragraph (c) below. Note that significant crosswinds may affect the velocity contours.

(3) Analyze the impact to the taxiway/taxilane system for taxi-in, taxi-out, pushback, and power-back parking operations.

(4) Perform a safety review on turbojet aircraft departing their gate or hardstand when performing a powered turning maneuver onto the taxiway/taxilane. When an aircraft executes a turning maneuver of 45 degrees or more from the gate/hardstand, additional jet blast hazards may be created (NASA/Aviation Safety Reporting System [ASRS] Directline Issue No. 6, August 1993, Ground Jet Blast Hazard).

Avoid terminal gate and hardstand aircraft parking layouts that have “tail-to-tail” parking between turbo-jet aircraft and (1) light aircraft (<12,500 lbs) and/or (2) narrow-body and wide-body aircraft. Provide tie-down anchors on apron areas which serve light aircraft especially when nearby taxiways/taxilanes serve turbojet aircraft. AC 20-35 provides information on anchor design.

**c. Velocity exposure rates.** The following maximum velocity exposure rates are from the National Weather Service (NWS) Beaufort Scale:

(1) Terminal tail-to-tail parking: 35 mph (56 kmh) maximum to reduce damage to adjacent aircraft, personnel and objects. It assumes ramp personnel are trained and aware that occasion wind peaks occur and may affect their ability to walk against the generated winds. Service roads may be directly behind the aircraft fuselage for tug/tractor service. No light general aviation aircraft or commuter aircraft should be parked adjacent to turbojet aircraft.

(2) Terminal parking where parallel or skewed terminals face each other:

(a) Use a 50 mph (80 kmh) maximum break-away condition to determine the “reach” of the initial jet blast from aircraft taxiing in/out one terminal into the facing terminal concourse and its associated service road.

(b) A 35 mph (56 kmh) maximum is suggested under breakaway conditions to locate the facing terminal gate parking and associated service roads. This value assumes that ramp personnel are trained to expect occasional wind burst from jet blast; there is no general aviation parking; and parked commuter aircraft do not board or deplane passengers directly to/from the apron.

(3) General aviation/commuter parked next to turbojet aircraft:

(a) Use a 24 mph (38 kmh) maximum under idle and breakway conditions. The lower exposure rate takes into account conditions experienced by passengers during bad weather when having to deal with umbrellas and slippery ramp/stairs. Idle and breakaway conditions are specified to handle the variety of possible gate layouts and ramp taxiing and tug operational policies and procedures.

(4) Hardstand(s): For hardstands, the focus is on mitigating the effects of “power + turn = hazard” taxiing operation.

(a) Use a 24 mph (38 kmh) maximum under idle conditions to locate an adjacent hardstand when passengers are boarding/deplaning directly from/to the apron.

(b) Use a 35 mph (56 kmh) maximum under idle conditions when aircraft are arriving/departing from the hardstands if the air carriers written ramp management plan prescribes that all passengers in the adjacent hardstand locations are boarded or escorted away from the active hardstand by trained ramp personnel.

(c) Use a 39 mph (62 kmh) maximum under breakaway conditions for the location of service roads aft of the parked turbojet aircraft. This value addresses drivers' control of vehicles/trucks when subjected to slightly higher winds and assumes no tug/tractor service operations at the hardstands.

(d) On service roads next to a hardstand location a 35 mph (56 kmh) maximum is suggested.

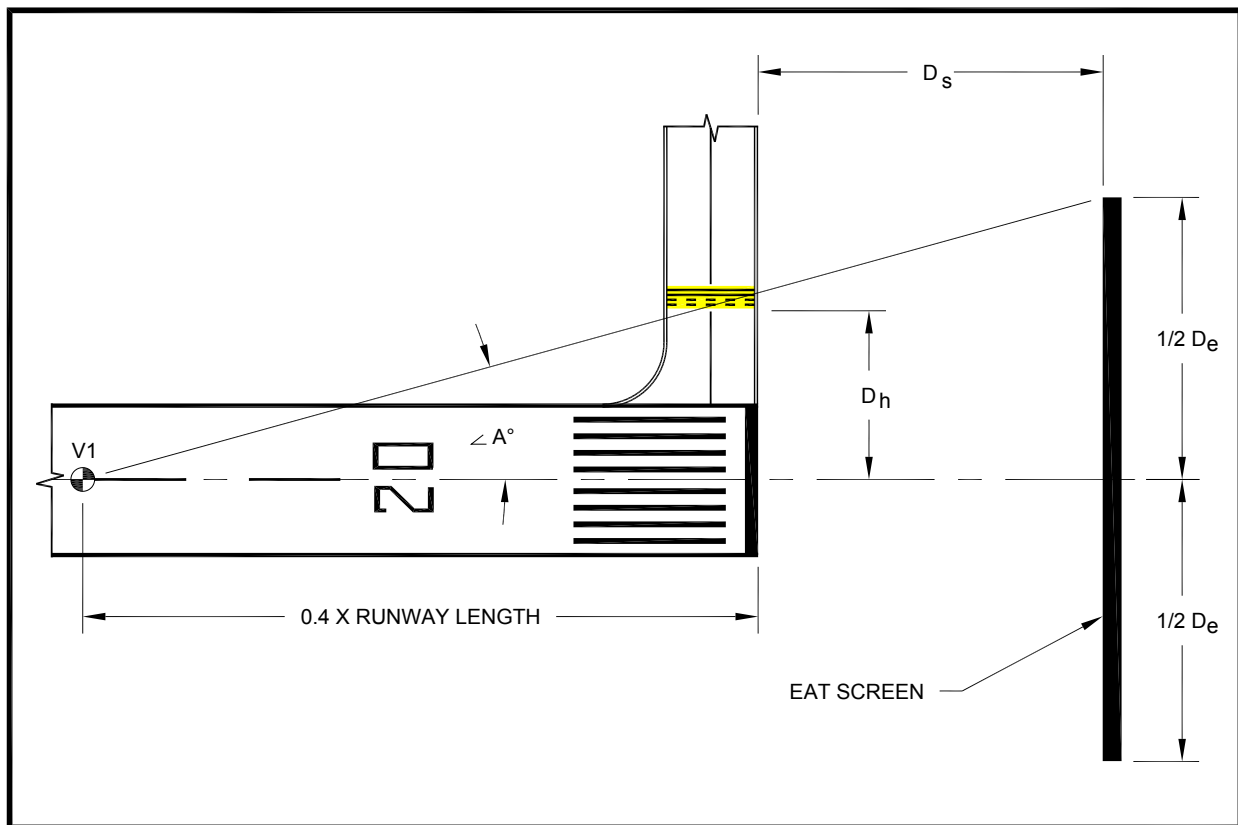
**Page intentionally left blank.**

## Appendix 4. End-Around Taxiway (EAT) Screens

### A4-1. Screen sizing.

The size of the EAT visual screen is dependent on the runway geometry, the Runway Design Code (RDC) of the aircraft operating on that particular departing runway and EAT, and the relative elevations of the EAT,  $V_1$  point, the ground at the screen, and the stop end of the runway.

**a. Horizontal geometry.** The width of the screen should be designed to be perceived by the departing aircraft to originate and end at the taxiway/runway hold line(s) at the stop end of the runway from the  $V_1$  point. In order to calculate the screen width, the distance to where the screen will be located beyond the runway end must first be determined. From the runway centerline  $V_1$  point, lines are drawn through the runway hold line position closest to the stop end of the runway (normally derived from the Hold Line Position in interactive [Table 3-5](#) and extended until they intersect with a line perpendicular to the runway at the screen location). See [Figure A4-1](#). Use the formula in [Figure A4-2](#) to calculate the width of the visual screen.



**Note:** See [Figure A4-2](#) for definitions of  $D_s$ ,  $D_h$ , and  $D_e$

**Figure A4-1. End-Around Taxiway (EAT) screen horizontal geometry**

$$\angle A = \arctan \frac{D_h}{D_v}$$
$$(\tan \angle A (D_v + D_s)) = \frac{1}{2} D_e$$

Where:

- $D_v = 0.4 \times \text{Runway Length}$
- $D_s = \text{Distance from the stop end of the runway to the screen.}$
- $D_h = \text{Distance from the runway centerline to the hold line.}$
- $D_e = \text{Width of the EAT visual screen.}$

**Figure A4-2. Visual screen width calculation**

**b. Vertical geometry.** The height of the screen must be designed so the top of the screen will mask that portion of an aircraft that extends up to the top of a wing-mounted engine nacelle of the Airplane Design Group (ADG) taxiing on the EAT, as viewed from the cockpit of the same ADG at the  $V_1$  point on the departure runway (see [Figure A4-3](#)). In general, the visual screen should extend from the ground to the calculated height. For ADG-III and above, it is permissible to have the lower limit of the visual screen up to two feet (0.5 m) above the stop end of the runway elevation. Variations in terrain at the site where the screen is to be constructed will need to be considered. It may be feasible to grade the site of the visual screen to allow for an additional 2-foot (0.5 m) separation between the visual screen panels and the ground for mowing access. A visual screen is not required if terrain masks the wing-mounted engine nacelle of the aircraft on the EAT (see [Figure A4-4](#)).

#### **A4-2. Screen construction.**

The visual screen must be constructed to perform as designed and be durable, resistant to weather, frangible, and resistant to expected wind load. The visual screen comprises foundations, frame, connection hardware, and front panels.

**a. Foundations.** The foundation of the screen structure must be sufficient to hold the visual screen in position. The base of the foundation should have a sufficient mow strip around it to provide a safety buffer between mowing equipment and the screen structure.

**b. Frame.** The frame structure of the screen must be constructed so it is durable, able to withstand wind loading, and frangible in construction. [Figure A4-5](#) illustrates three methods for constructing the frame structure, depending on the overall height of the structure. The visual screen structure should be constructed to allow the front panels of the screen to be angled upward  $12 (\pm 1^\circ)$  degrees from the vertical plane. All connections within the frame structure, the panels, and the foundations should be designed to break away from the structure in the event of an aircraft strike.

To calculate the required height of the screen above grade,  $H_s$ :

$$H_s = \frac{(ELEV_{VI} + H_{EYE} - H_{NACELLE} - ELEV_{EAT})(D_{EAT} - D_s)}{(D_{EAT} + 0.4 \times L_{RWY})} + H_{NACELLE} + ELEV_{EAT} - ELEV_{GAS}$$

Where:

$ELEV_{VI}$  = MSL elevation of the runway centerline at the  $V_1$  point, 60% of the length of the runway from the takeoff threshold

$ELEV_{SER}$  = MSL elevation of the stop end of the runway (SER).

$ELEV_{TOS}$  = MSL elevation of the top of the screen.

$ELEV_{NACELLE}$  = MSL elevation of the top of the engine nacelle.

$ELEV_{GAS}$  = MSL elevation of the ground at the screen.

$ELEV_{EAT}$  = MSL elevation of the centerline of the EAT.

$H_{NACELLE}$  = Height of the engine nacelle above the taxiway (See Table A4-1 below).

$H_{EYE}$  = Height of the pilot's eye above the runway (See Table A4-1 below).

$L_{RWY}$  = Length of the runway.

$D_s$  = Distance from the stop end of the runway to the screen.

$D_{EAT}$  = Distance from the stop end of the runway to the centerline of the EAT.

Check that the screen is below the 40:1 departure surface:

$$H_s + ELEV_{GAS} < D_s/40 + ELEV_{SER},$$

**Figure A4-3. EAT screen vertical dimension calculation**

A visual screen is not required if the elevation of the EAT is lower than the elevation of the stop end of the runway by at least:

$$\frac{H_{EYE} \times D_{EAT}}{.4 \times L_{RWY}} - H_{NACELLE}$$

**Figure A4-4. Stop end of the runway/EAT elevation difference**

**Table A4-1. Aircraft characteristics**

ADG	Nacelle Height (feet) ( $H_{NACELLE}$ )	Pilot's Eye Height (feet) ( $H_{EYE}$ )
III	9	15
IV	12	21
V	18	29
VI	18	29

Note: 1 ft = 0.305m

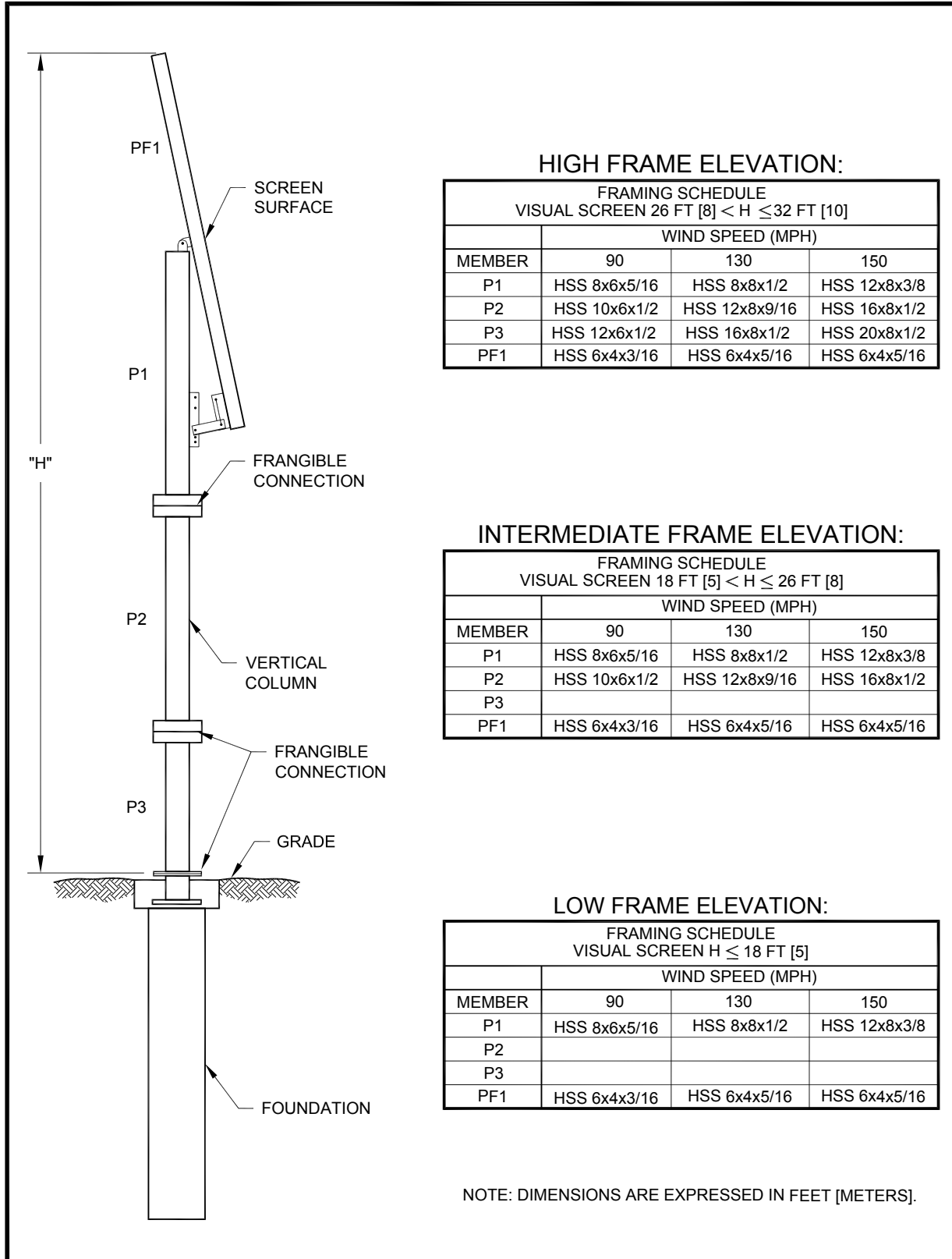


Figure A4-5. Examples of mounting screen to vertical column



**c. Front panel.** The front panel of the visual screen should be designed so it is conspicuous from the runway side of the screen. Replaceable front panels 12 feet (3.5 m) long and 4 feet (1 m) high and attached to the frame structure allow easy replacement if necessary. See [Figure A4-6](#). The following design has been determined to fulfill all requirements.

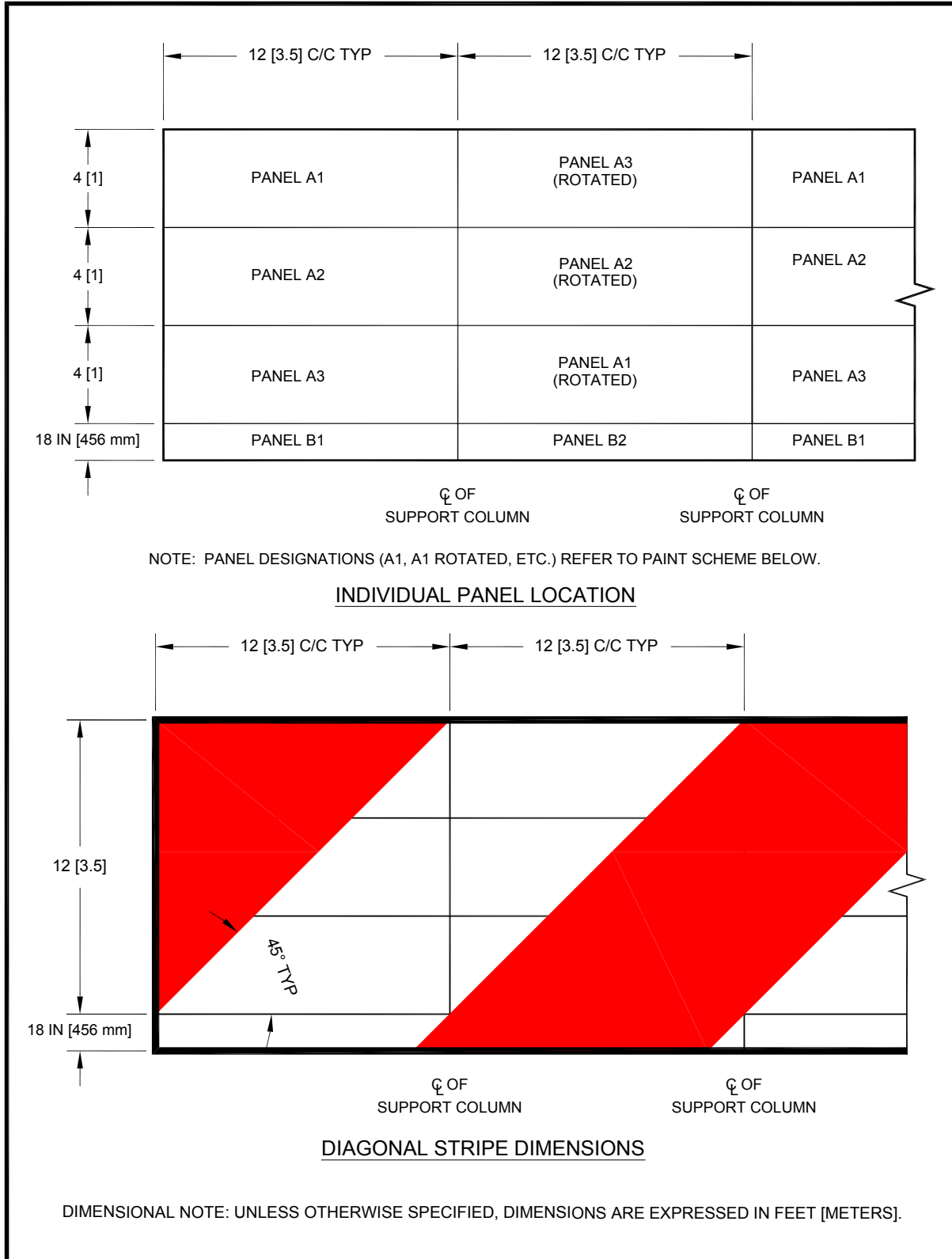
(1) **Aluminum Honeycomb Performance Criteria.** The screen panels are constructed of aluminum honeycomb material. The front panel of the screen is constructed of 4-foot-tall (1 m) panels, with the remaining difference added as required. For example, three 4-foot (1 m) high panels plus one 1-foot (0.5 m) tall panel would be used to create a 13-foot (4 m) tall screen. There is 0.5 inch space between panels to allow for thermal and deflection movements. The front and back panel faces should be specified to meet the required deflection allowance and should be a minimum 0.04 inches (1 mm) thick. The honeycomb material should be of sufficient thickness to meet the required deflection allowance, but should not be more than 3 inches (76 mm) thick. The internal aluminum honeycomb diameter should be of sufficient strength to meet the required deflection allowance, but should not be more than 0.75 inches (19 mm). The panel edge closures should be of aluminum tube that is 1 inch (25 mm) times the thickness of the honeycomb and sealed. The deflection allowance for the screen is 0.5 inches (13 mm) maximum at the center of the panel when supported by four points at the corner of the panel. The panel faces should have a clear anodized finish on both front and back.

(2) **Pattern.** The front panel of the screen visually depicts a continuous, alternating red and white, diagonal striping of 12-foot (3.5 m) wide stripes set at a 45-degree angle  $\pm$  five (5) degrees, sloped either all to the left or all to the right. To provide maximum contrast, the slope of the diagonal striping on the screen is opposite the slope of aircraft tails operating in the predominant flow on the EAT, as shown in [Figure A4-7](#).

(3) **Color.** The front panel of the screen is retroreflective red and white. The colors of the retroreflective sheeting used to create the visual screen conform to Chromaticity Coordinate Limits shown in [Table A4-2](#), when measured in accordance with FP-85, Section 718.01(a), or [ASTM D4956](#).

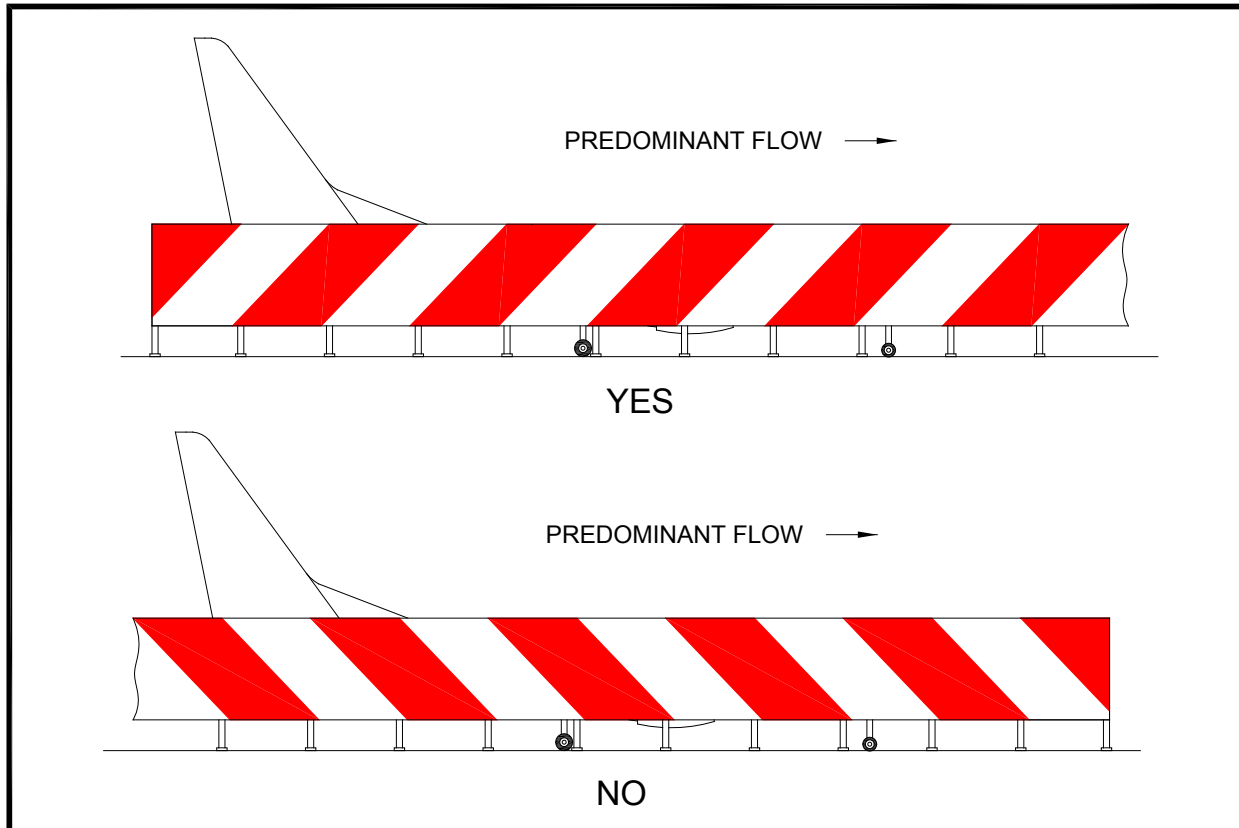
(4) **Reflectivity.** The surface of the front panel is reflective on the runway side of the screen. Measurements are made in accordance with [ASTM E810](#). The sheeting must maintain at least 90 percent of its values, as shown in [Table A4-3](#), with water falling on the surface, when measured in accordance with the standard rainfall test of FP-85, Section 718.02(a), and Section 7.10.0 of [AASHTO M268](#).

(5) **Adhesion.** The screen surface material has a pressure-sensitive adhesive, which conforms to adhesive requirements of FP-85 (Class 1) and [ASTM D4956](#) (Class 1). The pressure-sensitive adhesive is recommended for application by hand or with a mechanical squeeze roller applicator. This type adhesive lends itself to large-scale rapid production of signs, according to manufacturer's instructions.



**Note:** The front panel of the screen is retroreflective red and white (see paragraph [A4-1.c\(3\)](#)).

**Figure A4-6. Examples of panel layout for 13-foot (4 m) high screen**



**Note:** The front panel of the screen is retroreflective red and white (see paragraph [A4-1.c\(3\)](#)).

**Figure A4-7. Diagonal stripe orientation**

**Table A4-2. International Committee of Illumination (CIE) chromaticity coordinate limits**

Color	x	y	X	Y	x	y	x	y	Min	Max	Munsell Paper
White	.303	.287	.368	.353	.340	.380	.274	.316	35		6.3GY 6.77/0.8
Red	.613	.297	.708	.292	.636	.364	.558	.352	8.0	12.0	8.2R 3.78/14.0

**Table A4-3. Minimum coefficient of retroreflection candelas/foot candle/square foot/candelas/lux/square meter**

<b>Observation Angle<sup>1</sup> (Degrees)</b>	<b>Entrance Angle<sup>2</sup> (Degrees)</b>	<b>White</b>	<b>Red</b>
0.2	-4	70	14.5
0.2	+30	30	6.0
0.5	-4	30	7.5
0.5	+30	15	3.0

(Reflectivity must conform to FP-85 Table 718-1 and ASTM D4956.)

**Notes:**

1. Observation (Divergence) Angle – The angle between the illumination axis and the observation axis.
2. Entrance (Incidence) Angle – The angle from the illumination axis to the retroreflector axis. The retroreflector axis is an axis perpendicular to the retroreflective surface.

**d. Environmental performance.** The front panel of the screen surface material and all its required components must be designed for continuous outdoor use under the following conditions:

(1) Temperature. The screen surface material must withstand a specified ambient temperature range. A range of: -4°F to +130°F (-20°C to +55°C) is recommended.

(2) Wind Loading. The screen must be able to sustain exposure to a wind speed of at least 90 mph (145 k/h) or the appropriate wind speed anticipated for the specific airport location, whichever is greater. See Table A4-4 for wind pressures.

**Table A4-4. Visual screen panel wind loads**

<b>WIND SPEED (mph [k/h]) (3 SECOND GUST)</b>	<b>WIND LOAD (PSI)</b>
90 mph (145 k/h)	0.17
130 mph (209 k/h)	0.35
150 mph (241 k/h)	0.47

(3) Rain. The screen surface material must withstand exposure to wind-driven rain.

(4) Sunlight. The screen surface material must withstand exposure to direct sunlight.

(5) Lighting. If required, the top edge of the visual screen is illuminated with steady burning, L-810 FAA-approved obstruction lighting, as provided in AC 150/5345-43 and positioned as specified in AC 70/7460-1.

**e. Provision for alternate spacing of visual screen.** If access is needed through the area where the visual screen is constructed, various sections of the screen may be staggered up to 50 feet (15 m) from each other, as measured from the runway end, so an emergency vehicle can safely navigate between the staggered sections of screen. The sections of screen must be overlapped so the screen appears to be unbroken when viewed from the runway at the  $V_1$  takeoff position.

**f. Frangibility.** The screen structure, including all of its components, must be of the lowest mass possible to meet the design requirements so as to minimize damage should the structure be struck. The foundations at ground level must be designed so they will shear on impact, the vertical supports must be designed so they will give way, and the front panels must be designed so they will release from the screen structure if struck. The vertical support posts must be tethered at the base so they will not tumble when struck. [Figure A4-5](#) provides information on how this frangibility can be achieved. See [AC 150/5220-23](#) for more information.

**g. Navigation Aid (NAVAID) Consideration.** The following concerns must be considered when determining the siting and orientation of the visual screen. The visual screen may have adverse effects on NAVAIDs if it is not sited properly. The complexity of the airport environment requires that all installations be addressed on a case-by-case basis, so mitigations can be developed to ensure the installation of the visual screen does not negatively affect NAVAID performance.

**(1) Approach Light Plane.** No part of the visual screen may penetrate the approach light plane.

**(2) Radar Interference.** Research has shown that a visual screen erected on an airport equipped with Airport Surface Detection Equipment (ASDE) may reflect signals that are adverse to the ASDE operation. To avoid this, the visual screen should be tilted back/away (on the side facing the ASDE) 12 degrees ( $\pm 1^\circ$ ). This will minimize or eliminate false radar targets generated by reflections off the screen surface. Examples of this tilting are shown in [Figure A4-5](#).

**(3) Instrument Landing System (ILS) Interference.** Research has shown that a visual screen on a runway equipped with an ILS system (localizer [LOC] and glideslope [GS]) will generally not affect or interfere with the operation of the system. An analysis must be performed for GSs, especially null reference GSs, prior to the installation of the screens.

**Page intentionally left blank.**

## Appendix 5. General Aviation Aprons and Hangars

### A5-1. Background.

This appendix discusses general aviation aprons and hangars on an airport. These facilities may be at a general aviation airport or in an exclusively general aviation area of a commercial service airport. The function of an apron is to accommodate aircraft during loading and unloading of passengers and or cargo. Activities such as fueling, maintenance and short/long term parking take place on an apron. Apron layout depends on aircraft parking positions and movement patterns between these parking positions, hangars, and support facilities such as fueling, wash pads and any Fixed Base Operator (FBO) facilities. Well planned general aviation aprons and hangars minimize runway incursions and effectively expedite aircraft services. Refer to Chapter 5 for additional information on aprons.

### A5-2. General aviation apron.

**a. General.** Aprons and associated taxilanes should be designed for the critical design aircraft and/or the combination of aircraft to be using the facility. Itinerant or transient aprons should be designed for easy access by the aircraft under power. Aprons designed to handle jet aircraft should take into account the effects of jet blast and allow extra room for safe maneuvering. Tiedown aprons at general aviation airports usually are designed to accommodate aircraft in Airplane Design Groups (ADGs) I and II. Some tiedown stands should be provided for larger twin engine aircraft as needed to handle the demand.

**b. Itinerant aircraft.** Some apron area should be established to handle itinerant aircraft, which are usually only on the airport for a few days at the most. Wheel chocks are generally used rather than tiedown anchors. The aircraft stand can either be designed so that the aircraft can enter the stand under its own power or the aircraft may have to be pushed into the stand by hand or with a tug. Itinerant parking is generally associated with the FBO at a general aviation airport or can be accommodated near a terminal building. The terminal apron will generally set aside some area for itinerant general aviation aircraft.

**c. Tiedown apron.** Aircraft require tiedowns in the open. Open areas used for base aircraft tiedowns may be paved, unpaved or turf. The type of apron surface is dependent on the aircraft size, soil and weather conditions.

**d. Other Services Apron.** Apron areas must also accommodate aircraft servicing, fueling, loading and unloading of cargo.

**e. Area allowance.** The total amount of apron area required is based on local conditions and will vary from airport to airport. The area required per aircraft for a typical itinerant/transient apron at a general aviation airport will vary based on the design aircraft or fleet mix selected for the design.

**f. Tiedown layout.** The layout of tiedown stands for small aircraft on an apron can vary by the space and shape of the area available. The layout should maximize the number of stands, while still providing the required taxilane Object Free Areas (OFAs) and wingtip clearance. A minimum of 10 feet (3 m) clearance should be provided between the wings of

parked small aircraft. General information on tiedown techniques and procedures is contained in AC 20-35.

**g. Transient apron.** The area required per aircraft for a typical itinerant/transient apron at a general aviation airport will vary based on the design aircraft or fleet mix selected for the design.

### **A5-3. Wash pads.**

Wash pads are dedicated areas on an apron where the aircraft can be washed. The pavement is sloped to a drain that is connected to a sanitary sewer system or other treatment system, which is separate from the storm water piping. Water hoses are located near the pads.

### **A5-4. Fueling.**

Aircraft fueling is done on apron in a number of ways. Fuel trucks can come to parked aircraft or general aviation aircraft can be pushed, towed or taxied to fuel pumps that may be located either in a fuel island or along the apron edges. Self-fueling of one's own aircraft is permissible under certain circumstances. Refer to the appropriate FAA regulations and local requirements for the self-fueling of general aviation aircraft. Asphaltic concrete pavement may require protection from fuel and oil spills. See AC 150/5230-4 and NFPA 407 for more information on fueling.

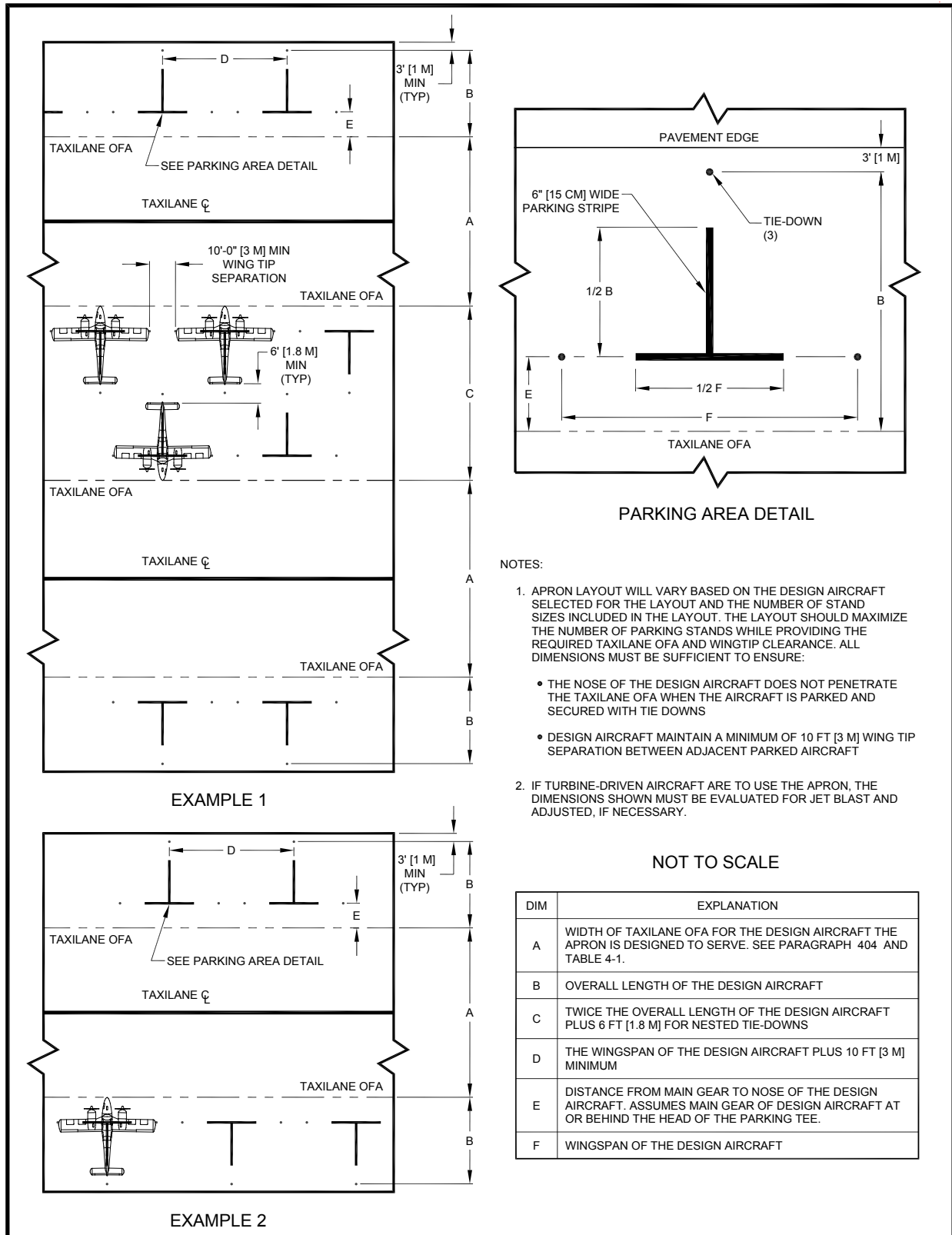
### **A5-5. Object clearance.**

Table 4-1 gives the required taxiway and taxiway OFA and wingtip clearance for each Airplane Design Group (ADG). All parked aircraft must remain clear of the OFAs of runways and taxiways/taxilanes. The aircraft also must not penetrate the runway approach and departure surfaces as described in paragraph 303.

### **A5-6. Surface gradients.**

The recommended surface gradients have been developed to ease aircraft towing and taxiing while promoting positive drainage. The maximum allowable grade in any direction is 2.0 percent for Aircraft Approach Categories A and B and 1.0 percent for Aircraft Approach Categories C, D, and E. The maximum grade change is 2.0 percent. There is no requirement for vertical curves, though on aprons designed for small propeller aircraft, special consideration should be made to reduce the chance of dinging low hanging propellers as the aircraft taxis through a swale at a catch basin. Near aircraft parking areas it is desirable to keep the slope closer to 1.0 percent to facilitate moving the aircraft into the stands. This flatter slope is also desirable for the pavement in front of hangar doors. Design apron grades to direct drainage away from any building, especially in fueling areas. Aircraft fueling aprons should slope away from all buildings at a minimum grade of 1.0 percent for the first 50 feet; then the apron slope to the drainage inlets can be reduced to a minimum slope of 0.5 percent. There should be a 1.5 inch (40 mm) drop-off at the pavement edge with the adjacent area sloped between 3.0 and 5.0 percent away from the pavement. Reference NFPA 415.





**Figure A5-1. Tiedown layouts**

### **A5-7. Drainage.**

The drainage systems to handle the storm water runoff from an apron should be designed to handle the critical design storm events consistent with AC 150/5320-5 and local drainage requirements. Often, linear trench drains or slot drains are employed because they make it easier to design collection of runoff with the flatter slopes used on aprons. Since there can be fuel and oil spills on aprons, oil water separators and other appropriate treatment systems into the drainage systems. See NFPA 415 for additional information.

### **A5-8. Marking and lighting.**

See AC 150/5340-1 for marking design information. Non-movement area marking is generally used between taxiways and aprons, as aprons are considered to be non-movement areas.

Area lighting of apron areas is desirable, especially at FBO facilities. The area light beams must be directed downward and away from runway approaches and control towers. Shielding of the lights may be needed to minimize unwanted glare. Area light spread should cover aircraft service areas. Refer to Illuminating Engineering Society of North America (IES), Recommended Practice for Airport Service Area Lighting, for additional guidance on apron area lighting.

The height of the floodlight poles must not exceed the runway approach and departure surfaces as described in paragraph 303. The height of floodlight poles must also be evaluated for Part 77 surface penetrations. An airspace determination is required prior to installation of poles for airport lighting.

### **A5-9. Hangars.**

Many aircraft owners will prefer to have their aircraft stored in hangars for security and protection against wind and other adverse weather conditions. Hangars can be rectangular or corporate style buildings separated from the next hangar. Hangar bays can be joined together (nested) in T-hangars holding 4-12 bays. Usually interior walls separate the individual bays and each bay has its own door. Other T-hangars can be open canopies without doors or interior walls. Doors generally slide horizontally and stack to the side of the hangar opening, some have bi-fold or fabric doors which retract up. The hangar structures can be fabricated from wood, steel or concrete. Corrugated metal or aluminum siding is also used. T-hangars are designed to maximize the number of aircraft per apron area. Corporate hangars often have small offices with restrooms. Box hangars can be sized larger to store multiple aircraft of varying sizes. The key dimensions of a hangar bay are clear door opening width and height and bay depth. Local permitting agencies may require nearby fire hydrants, sprinkler systems, fire alarm systems, personnel doors, floor drains and other building safety items, depending on the size of the hangar. Building codes make a distinction between storage hangars allowing, minor replacement of maintenance parts and aircraft major repair hangars.

**a. T-Hangars.** The floor plan of a T-Hangar bay is shaped as a tee with a wide space for the wing and a narrow space for the tail. The layout of a T-hangar can vary by manufacturer. Some have the tail space in one bay - back to back - with the tail space on the opposite side of the hangar. Others have nested arrangement of the bays. Manufacturers make several models based on the various sizes of aircraft. Additional bays in pairs can be added to the typical 4 bay

unit. T-hangars generally are made to accommodate aircraft wingspans up to 55 feet (17 m). A layout of T-hangars with either a single taxilane or a dual taxilane arrangement (sometimes used in large T-hangar complexes to allow for passing of aircraft) must meet the taxilane separation standards in [Table 4-1](#). Refer to [NFPA 409](#) for minimum separation required between single hangar buildings.

**b. Corporate hangars.** Corporate or box hangars are generally separated from other hangars, but sometimes they are joined side by side in groups of 4-6 bays in one building. Most corporate hangars have a minimum opening of 50 feet (15 m) and the layout is usually square, being 50 feet (15 m) by 50 feet (15 m) or larger. Certain corporate jet aircraft cannot fit in T-hangar bays due to the configuration of the wings, even though they may have short enough wingspans. Sometimes larger corporate hangars accommodate several aircraft of varying size. Corporate hangars should be placed on the perimeter of aircraft storage areas since the aircraft doors are on one side.

**c. Safety considerations must be incorporated into the design of all hangars:**

**(1) Clearances.** Hangar design must at all times allow aircraft to maintain specified clearances during movement activities.

**(2) Services.** All repair services provided inside hangars should be allowed to incorporate safety procedures including fueling and defueling activities when necessary.

**(3) Hazards.** A hangar must incorporate subfloor design measures to mitigate fuel and oil spillage. Hangars used for light or heavy maintenance/repairs and overhauls of aircraft engines must consider the installation of oil, water and fuel separation system. Design should mitigate any fuel or hazardous fumes from accumulating in high concentrations inside a hangar.

**(4) Security.** On or off airport hangars must be designed to take into account protecting the aircraft from access by unauthorized personnel.

**Page intentionally left blank.**

## Appendix 6. Compass Calibration Pad

### A6-1. Purpose.

This appendix provides guidelines for the design, location and construction of a compass calibration pad and basic information concerning its use in determining the deviation error in an aircraft magnetic compass.

### A6-2. Background.

a. An aircraft magnetic compass is a navigation instrument with certain inherent errors resulting from the nature of its construction. All types of magnetic compasses indicate direction with respect to the earth's magnetic field. This is true even for the gyro-stabilized and/or fluxgate compasses. Aircraft navigation is based on applying the appropriate angular corrections to the magnetic reading in order to obtain the true heading.

b. The aircraft magnetic compass should be checked following pertinent aircraft modifications and on a frequent, routine schedule. One method of calibrating the compass is to use a compass calibration pad to align the aircraft on known magnetic headings and make adjustments to the compass and/or placard markings to indicate the required corrections.

### A6-3. Design of compass calibration pad.

The design details in this appendix are provided for guidance only. Variations of these designs are acceptable provided the general requirements are met.

a. The compass calibration pad markings consist of a series of 12 radials painted on the pavement with non-metallic paint. The radials extend toward the determined magnetic headings every 30 degrees beginning with magnetic north (MN). Except for magnetic north, which is marked with "MN," each radial should be marked with its magnetic heading at the end of the radial indicating the direction along which each line lies; e.g., "MN" for magnetic north; "030" for 30 degrees, etc. Each heading, except for magnetic north, will consist of three numerals, 24-inches (610 mm) high by 15-inches (381 mm) wide block numerals with a minimum 3.5-inch (89 mm) wide stroke. The markings must be large enough to be easily read from the aircraft cockpit as the radial is being approached. Figure A6-1 shows a layout of the calibration pad markings.

b. Figure A6-2 depicts a typical calibration pad. It can be constructed of either concrete or asphalt pavement. The pavement thickness must be adequate to support the user aircraft and should be designed in accordance with AC 150/5320-6. For concrete pavements, joint type and spacing should conform to standard practices, with no magnetic (iron, steel or ferrous) materials used in its construction. Therefore, dowels (where required) and any other metallic materials must be aluminum, brass, bronze, or fiberglass, rather than steel.

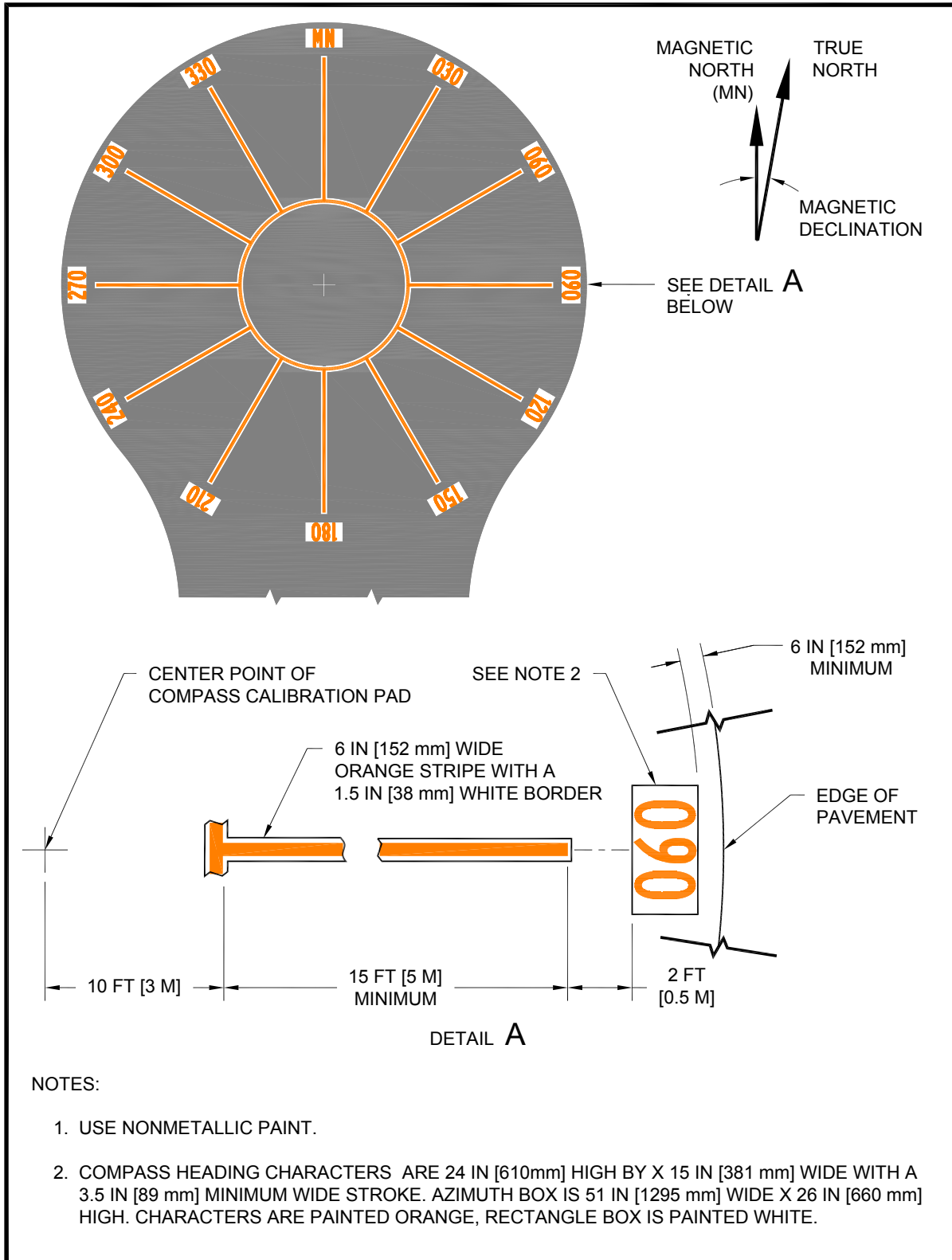
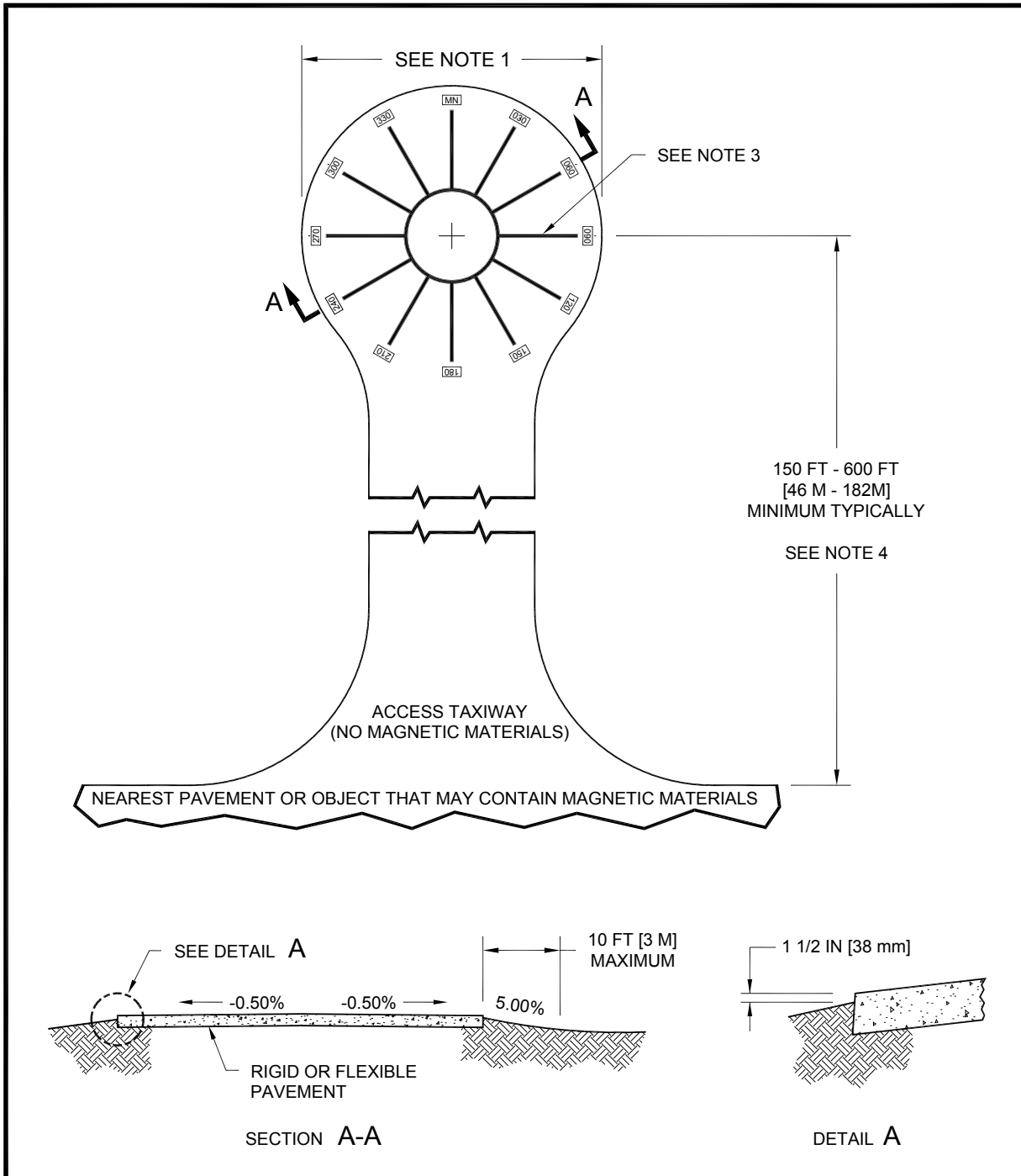


Figure A6-1. Compass calibration pad marking layout



**Notes:**

1. Diameter of calibration pad varies depending on requirements of user aircraft.
2. Use aluminum or non-metallic pipe when drainage is necessary with 150 ft (46 m) of the center of the pad.
3. See [Figure A6-1](#) for marking layout.
4. Varies per site conditions and airport design criteria. Refer to paragraph [A6-3](#).

**Figure A6-2. Typical compass calibration pad**

#### **A6-4. Location of compass calibration pad.**

The requirements specified herein have been determined through consultation with instrument calibration specialists, Fixed Base Operators (FBOs), and persons in the US Geological Survey with considerable experience in performing surveys of compass calibration pads.

**a.** Locate the center of the pad at least 600 feet (183 meters) from magnetic objects such as large parking lots, busy roads, railroad tracks, high voltage electrical transmission lines or cables carrying direct current (either above or below ground). Locate the center of the pad at least 300 feet (91 meters) from buildings, aircraft arresting gear, fuel lines, electrical or communication cable conduits when they contain magnetic (iron, steel, or ferrous) materials and from other aircraft. Runway and taxiway light bases, airfield signs, ducts, grates for drainage when they contain iron, steel, or ferrous materials should be at least 150 feet (46 m) from the center of the pad. In order to prevent interference with electronic Navigation Aid (NAVAID) facilities located on the airport, be sure the required clearances are maintained in accordance with the requirements in Chapter 6.

**b.** The compass calibration pad must be located outside airport design surfaces to satisfy the runway and taxiway clearances applicable to the airport on which it is located.

**c.** After tentative selection of a site through visual application of appropriate criteria listed above, make a thorough magnetic survey of the site(s). Many sites which meet all visually applied criteria regarding distances from structures, etc., may still be unsatisfactory because of locally generated or natural magnetic anomalies. At locations near heavy industrial areas, intermittent magnetic variations may be experienced. Appropriate magnetic surveys at various periods of time are necessary to determine if this situation exists.

**d.** The difference between magnetic and true north (referred to as magnetic variation or declination) must be uniform in the vicinity of the site. Magnetic surveys must be made to determine that the angular difference between true and magnetic north measured at any point does not differ from the angular difference measured at any other point by more than one-half degree (30 minutes of arc) within a space between 2 and 10 feet (0.5 and 3 meters) above the ground above the surface of the base and extending over an area within a 250-foot (76 meters) radius from the center of the pad. Exceptions can be made for small anomalies provided it can be shown through the magnetic surveys to have no effect on any magnetic measurements on the paved portion of the compass calibration pad. All exceptions must be noted in the compass rose report and certification that must be provided by the geophysicist, surveyor or engineer making the magnetic surveys.

**e.** A suggested method for the magnetic surveys is described below:

**(1)** Make a preliminary total field survey of the (proposed) pad and surrounding area using a total field magnetometer. Measurements should be made in a grid pattern with 5-foot (1.5 m) spacing on the (proposed) pad, 10-foot (3 m) spacing from the edge of the (proposed) pad to 150-foot (46 m) from the center, and 20-foot (6 m) spacing on the cardinal headings (north, south, east, and west) out to 250-foot (76 m) from the center of the pad. The reading on the (proposed) pad should have a range of 75 nT (nanoTesla) or less. The range



should be 125 nT or less from the edge of the (proposed) pad out to 150-feet (46 m) from the center of the pad, and a range of less than 200nT from 150-feet (46 m) out to 250-feet (76 m) from the center of the (proposed) pad. Several sites can typically be evaluated in a day using this method. Once a suitable site is located, proceed to the next step.

(2) Establish a grid centered on the pad with 20-foot (6 m) to 30-foot (9 m) spacing. There will typically be 5 or 7 lines. Place azimuth stakes at one end of the grid lines at least 400-feet (122 m) from the center. Establish the true azimuth of the grid by Global Positioning System (GPS), solar or star observations, or gyrocompass. Locate a minimum of 8 additional points, 100-feet (30 m) and 200-feet (61 m) respectively, from the center of the pad on the 4 cardinal headings of the grid. Establish a true azimuth to at least 3 permanent objects on or near the airfield from the center of the (proposed) pad. The true azimuths will be used to locate the magnetic radials and for future magnetic surveys.

(3) Measure declination at each grid point and each additional point. During the measurement of declination, the center point must be re-occupied approximately every 30 minutes in order to determine the diurnal (daily) variation of the magnetic field in order to cancel the diurnal change from the readings and to determine the average value of declination.

(4) Mark on the pavement the location where radials must be painted within 1 minute of the magnetic bearing indicated.

(5) Submit a written report to the airport or agency requesting the surveys. The report should include all results, equipment calibration information, and a drawing showing the declination survey results.

#### **A6-5. Construction of compass calibration pad.**

For pavement design and construction, the applicable portions of AC 150/5320-6 and AC 150/5370-10 should be used. The following additional information is important:

a. Do not use magnetic materials, such as reinforcing steel or ferrous aggregate, in the construction of the calibration pad or of any pavement within a 300-foot (91 m) radius of the center of the site. If a drainage pipe is required within 300 feet (91 m) of the center of the site, use a non-metallic or aluminum material.

b. Each of the radials is oriented within one minute of the magnetic bearing indicated by its markings.

c. Mark the date of observation and any annual change in direction of magnetic north durably and legibly on the surface of the calibration pad near the magnetic north mark. Establish a permanent monument at some remote location on the true north radial for future reference.

d. After all construction work on the compass pad is completed, the pad must be magnetically resurveyed to show that magnetic materials were not introduced during construction and to establish the current magnetic headings.

e. Magnetic surveys of existing compass calibration pads must be performed at regular intervals of 5 years or less. Additional surveys must be performed after major construction of utility lines, buildings, or any other structures within 600 feet (183 m) of the center of the pad or after any construction within 150 feet (46 m) of the center of the pad. Pads not resurveyed after 5 years or after nearby construction should not be used.

f. The U.S. Geological Survey (USGS) of the Department of Interior is available to provide information to airports and others on the necessary surveys and equipment to certify a compass rose. In addition, the USGS is available to calibrate magnetometers and other suitable instruments used to measure the magnetic field. The instruments are necessary to determine the difference between true and magnetic north and the uniformity of the magnetic field in the area of a compass calibration pad and must be regularly calibrated to make accurate measurements. The cost for calibration service is only that necessary to cover the cost. Requests for this service should be made to the following:

U.S. Geological Survey  
Geomagnetism Group  
Box 25046, MS 966  
Denver, CO 80225  
Tel: 303-273-8475  
Fax: 303-273-8450  
website: [geomag.usgs.gov](http://geomag.usgs.gov)

There are also many other competent geophysicists, surveyors or engineers who are capable of performing compass rose surveys.

**Appendix 7. Runway Design Standards Matrix**

**Table A7-1. Runway design standards matrix, A/B-I Small Aircraft**

<i>Aircraft Approach Category (AAC) and Airplane Design Group (ADG):</i>		<b>A/B - I Small Aircraft</b>			
<b>ITEM</b>	<b>DIM <sup>1</sup></b>	<b>VISIBILITY MINIMUMS</b>			
		Visual	Not Lower than 1 mile	Not Lower than 3/4 mile	Lower than 3/4 mile
<b>RUNWAY DESIGN</b>					
Runway Length	A	<i>Refer to paragraphs 302 and 304</i>			
Runway Width	B	60 ft	60 ft	60 ft	75 ft
Shoulder Width		10 ft	10 ft	10 ft	10 ft
Blast Pad Width		80 ft	80 ft	80 ft	95 ft
Blast Pad Length		60 ft	60 ft	60 ft	60 ft
Crosswind Component		10.5 knots	10.5 knots	10.5 knots	10.5 knots
<b>RUNWAY PROTECTION</b>					
Runway Safety Area (RSA)					
Length beyond departure end <sup>9,10</sup>	R	240 ft	240 ft	240 ft	600 ft
Length prior to threshold	P	240 ft	240 ft	240 ft	600 ft
Width	C	120 ft	120 ft	120 ft	300 ft
Runway Object Free Area (ROFA)					
Length beyond runway end	R	240 ft	240 ft	240 ft	600 ft
Length prior to threshold	P	240 ft	240 ft	240 ft	600 ft
Width	Q	250 ft	250 ft	250 ft	800 ft
Runway Obstacle Free Zone (ROFZ)					
Length		<i>Refer to paragraph 308</i>			
Width		<i>Refer to paragraph 308</i>			
Precision Obstacle Free Zone (POFZ)					
Length		N/A	N/A	N/A	N/A
Width		N/A	N/A	N/A	N/A
Approach Runway Protection Zone (RPZ)					
Length	L	1,000 ft	1,000 ft	1,700 ft	2,500 ft
Inner Width	U	250 ft	250 ft	1,000 ft	1,000 ft
Outer Width	V	450 ft	450 ft	1,510 ft	1,750 ft
Acres		8.035	8.035	48.978	79.000
Departure Runway Protection Zone (RPZ)					
Length	L	1,000 ft	1,000 ft	1,000 ft	1,000 ft
Inner Width	U	250 ft	250 ft	250 ft	250 ft
Outer Width	V	450 ft	450 ft	450 ft	450 ft
Acres		8.035	8.035	8.035	8.035
<b>RUNWAY SEPARATION</b>					
<i>Runway centerline to:</i>					
Parallel runway centerline	H	<i>Refer to paragraph 316</i>			
Holding Position		125 ft	125 ft	125 ft	175 ft
Parallel taxiway/taxilane centerline <sup>2,4</sup>	D	150 ft	150 ft	150 ft	200 ft
Aircraft parking area	G	125 ft	125 ft	125 ft	400 ft

**Note:**

- Values in the table are rounded to the nearest foot. 1 foot = 0.305 meters.

**Table A7-2. Runway design standards matrix, A/B - I**

<i>Aircraft Approach Category (AAC) and Airplane Design Group (ADG):</i>		<b>A/B - I</b>			
<b>ITEM</b>	<b>DIM<sup>1</sup></b>	<b>VISIBILITY MINIMUMS</b>			
		Visual	Not Lower than 1 mile	Not Lower than 3/4 mile	Lower than 3/4 mile
<b>RUNWAY DESIGN</b>					
Runway Length	A	<i>Refer to paragraphs 302 and 304</i>			
Runway Width	B	60 ft	60 ft	60 ft	100 ft
Shoulder Width		10 ft	10 ft	10 ft	10 ft
Blast Pad Width		80 ft	80 ft	80 ft	120 ft
Blast Pad Length		100 ft	100 ft	100 ft	100 ft
Crosswind Component		10.5 knots	10.5 knots	10.5 knots	10.5 knots
<b>RUNWAY PROTECTION</b>					
Runway Safety Area (RSA)					
Length beyond departure end <sup>9,10</sup>	R	240 ft	240 ft	240 ft	600 ft
Length prior to threshold	P	240 ft	240 ft	240 ft	600 ft
Width	C	120 ft	120 ft	120 ft	300 ft
Runway Object Free Area (ROFA)					
Length beyond runway end	R	240 ft	240 ft	240 ft	600 ft
Length prior to threshold	P	240 ft	240 ft	240 ft	600 ft
Width	Q	400 ft	400 ft	400 ft	800 ft
Runway Obstacle Free Zone (ROFZ)					
Length		<i>Refer to paragraph 308</i>			
Width		<i>Refer to paragraph 308</i>			
Precision Obstacle Free Zone (POFZ)					
Length		N/A	N/A	N/A	200 ft
Width		N/A	N/A	N/A	800 ft
Approach Runway Protection Zone (RPZ)					
Length	L	1,000 ft	1,000 ft	1,700 ft	2,500 ft
Inner Width	U	500 ft	500 ft	1,000 ft	1,000 ft
Outer Width	V	700 ft	700 ft	1,510 ft	1,750 ft
Acres		13.770	13.770	48.978	78.914
Departure Runway Protection Zone (RPZ)					
Length	L	1,000 ft	1,000 ft	1,000 ft	1,000 ft
Inner Width	U	500 ft	500 ft	500 ft	500 ft
Outer Width	V	700 ft	700 ft	700 ft	700 ft
Acres		13.770	13.770	13.770	13.770
<b>RUNWAY SEPARATION</b>					
<i>Runway centerline to:</i>					
Parallel runway centerline	H	<i>Refer to paragraph 316</i>			
Holding Position		200 ft	200 ft	200 ft	250 ft
Parallel taxiway/taxilane centerline <sup>2,4</sup>	D	225 ft	225 ft	225 ft	250 ft
Aircraft parking area	G	200 ft	200 ft	200 ft	400 ft
Helicopter touchdown pad		<i>Refer to AC 150/5390-2</i>			

**Note:**

- Values in the table are rounded to the nearest foot. 1 foot = 0.305 meters.

**Table A7-3. Runway design standards matrix, A/B – II Small Aircraft**

<i>Aircraft Approach Category (AAC) and Airplane Design Group (ADG):</i>		<b>A/B - II Small Aircraft</b>			
ITEM	DIM <sup>1</sup>	VISIBILITY MINIMUMS			
		Visual	Not Lower than 1 mile	Not Lower than 3/4 mile	Lower than 3/4 mile
<b>RUNWAY DESIGN</b>					
Runway Length	A	<i>Refer to paragraphs 302 and 304</i>			
Runway Width	B	75 ft	75 ft	75 ft	100 ft
Shoulder Width		10 ft	10 ft	10 ft	10 ft
Blast Pad Width		95 ft	95 ft	95 ft	120 ft
Blast Pad Length		150 ft	150 ft	150 ft	150 ft
Crosswind Component		13 knots	13 knots	13 knots	13 knots
<b>RUNWAY PROTECTION</b>					
Runway Safety Area (RSA)					
Length beyond departure end <sup>9, 10</sup>	R	300 ft	300 ft	300 ft	600 ft
Length prior to threshold	P	300 ft	300 ft	300 ft	600 ft
Width	C	150 ft	150 ft	150 ft	300 ft
Runway Object Free Area (ROFA)					
Length beyond runway end	R	300 ft	300 ft	300 ft	600 ft
Length prior to threshold	P	300 ft	300 ft	300 ft	600 ft
Width	Q	500 ft	500 ft	500 ft	800 ft
Runway Obstacle Free Zone (ROFZ)					
Length		<i>Refer to paragraph 308</i>			
Width		<i>Refer to paragraph 308</i>			
Precision Obstacle Free Zone (POFZ)					
Length		N/A	N/A	N/A	200 ft
Width		N/A	N/A	N/A	800 ft
Approach Runway Protection Zone (RPZ)					
Length	L	1,000 ft	1,000 ft	1,700 ft	2,500 ft
Inner Width	U	250 ft	250 ft	1,000 ft	1,000 ft
Outer Width	V	450 ft	450 ft	1,510 ft	1,750 ft
Acres		8.035	8.035	48.978	79.000
Departure Runway Protection Zone (RPZ)					
Length	L	1,000 ft	1,000 ft	1,000 ft	1,000 ft
Inner Width	U	250 ft	250 ft	500 ft	500 ft
Outer Width	V	450 ft	450 ft	700 ft	700 ft
Acres		8.035	8.035	13.770	13.770
<b>RUNWAY SEPARATION</b>					
<i>Runway centerline to:</i>					
Parallel runway centerline	H	<i>Refer to paragraph 316</i>			
Holding Position		125 ft	125 ft	125 ft	175 ft
Parallel taxiway/taxilane centerline <sup>2, 4</sup>	D	240 ft	240 ft	240 ft	300 ft
Aircraft parking area	G	250 ft	250 ft	250 ft	400 ft
Helicopter touchdown pad		<i>Refer to AC 150/5390-2</i>			

**Note:**

- Values in the table are rounded to the nearest foot. 1 foot = 0.305 meters.

**Table A7-4. Runway design standards matrix, A/B – II**

<i>Aircraft Approach Category (AAC) and Airplane Design Group (ADG):</i>		<b>A/B - II</b>			
<b>ITEM</b>	<b>DIM <sup>1</sup></b>	<b>VISIBILITY MINIMUMS</b>			
		Visual	Not Lower than 1 mile	Not Lower than 3/4 mile	Lower than 3/4 mile
<b>RUNWAY DESIGN</b>					
Runway Length	A	<i>Refer to paragraphs 302 and 304</i>			
Runway Width	B	75 ft	75 ft	75 ft	100 ft
Shoulder Width		10 ft	10 ft	10 ft	10 ft
Blast Pad Width		95 ft	95 ft	95 ft	120 ft
Blast Pad Length		150 ft	150 ft	150 ft	150 ft
Crosswind Component		13 knots	13 knots	13 knots	13 knots
<b>RUNWAY PROTECTION</b>					
Runway Safety Area (RSA)					
Length beyond departure end <sup>9, 10</sup>	R	300 ft	300 ft	300 ft	600 ft
Length prior to threshold	P	300 ft	300 ft	300 ft	600 ft
Width	C	150 ft	150 ft	150 ft	300 ft
Runway Object Free Area (ROFA)					
Length beyond runway end	R	300 ft	300 ft	300 ft	600 ft
Length prior to threshold	P	300 ft	300 ft	300 ft	600 ft
Width	Q	500 ft	500 ft	500 ft	800 ft
Runway Obstacle Free Zone (ROFZ)					
Length		<i>Refer to paragraph 308</i>			
Width		<i>Refer to paragraph 308</i>			
Precision Obstacle Free Zone (POFZ)					
Length		N/A	N/A	N/A	200 ft
Width		N/A	N/A	N/A	800 ft
Approach Runway Protection Zone (RPZ)					
Length	L	1,000 ft	1,000 ft	1,700 ft	2,500 ft
Inner Width	U	500 ft	500 ft	1,000 ft	1,000 ft
Outer Width	V	700 ft	700 ft	1,510 ft	1,750 ft
Acres		13.770	13.770	48.978	78.914
Departure Runway Protection Zone (RPZ)					
Length	L	1,000 ft	1,000 ft	1,000 ft	1,000 ft
Inner Width	U	500 ft	500 ft	500 ft	500 ft
Outer Width	V	700 ft	700 ft	700 ft	700 ft
Acres		13.770	13.770	13.770	13.770
<b>RUNWAY SEPARATION</b>					
<i>Runway centerline to:</i>					
Parallel runway centerline	H	<i>Refer to paragraph 316</i>			
Holding Position		200 ft	200 ft	200 ft	250 ft
Parallel taxiway/taxilane centerline <sup>2, 4</sup>	D	240 ft	240 ft	240 ft	300 ft
Aircraft parking area	G	250 ft	250 ft	250 ft	400 ft
Helicopter touchdown pad		<i>Refer to AC 150/5390-2</i>			

**Note:**

- Values in the table are rounded to the nearest foot. 1 foot = 0.305 meters.

**Table A7-5. Runway design standards matrix, A/B - III**

<i>Aircraft Approach Category (AAC) and Airplane Design Group (ADG):</i>		<b>A/B - III</b>			
<b>ITEM</b>	<b>DIM <sup>1</sup></b>	<b>VISIBILITY MINIMUMS</b>			
		Visual	Not Lower than 1 mile	Not Lower than 3/4 mile	Lower than 3/4 mile
<b>RUNWAY DESIGN</b>					
Runway Length	A	<i>Refer to paragraphs 302 and 304</i>			
Runway Width	B	100 ft	100 ft	100 ft	100 ft
Shoulder Width		20 ft	20 ft	20 ft	20 ft
Blast Pad Width		140 ft	140 ft	140 ft	140 ft
Blast Pad Length		200 ft	200 ft	200 ft	200 ft
Crosswind Component		16 knots	16 knots	16 knots	16 knots
<b>RUNWAY PROTECTION</b>					
Runway Safety Area (RSA)					
Length beyond departure end <sup>9,10</sup>	R	600 ft	600 ft	600 ft	800 ft
Length prior to threshold <sup>11</sup>	P	600 ft	600 ft	600 ft	600 ft
Width	C	300 ft	300 ft	300 ft	400 ft
Runway Object Free Area (ROFA)					
Length beyond runway end	R	600 ft	600 ft	600 ft	800 ft
Length prior to threshold <sup>11</sup>	P	600 ft	600 ft	600 ft	600 ft
Width	Q	800 ft	800 ft	800 ft	800 ft
Runway Obstacle Free Zone (ROFZ)					
Length		<i>Refer to paragraph 308</i>			
Width		<i>Refer to paragraph 308</i>			
Precision Obstacle Free Zone (POFZ)					
Length		N/A	N/A	N/A	200 ft
Width		N/A	N/A	N/A	800 ft
Approach Runway Protection Zone (RPZ)					
Length	L	1,000 ft	1,000 ft	1,700 ft	2,500 ft
Inner Width	U	500 ft	500 ft	1,000 ft	1,000 ft
Outer Width	V	700 ft	700 ft	1,510 ft	1,750 ft
Acres		13.770	13.770	48.978	78.914
Departure Runway Protection Zone (RPZ)					
Length	L	1,000 ft	1,000 ft	1,000 ft	1,000 ft
Inner Width	U	500 ft	500 ft	500 ft	500 ft
Outer Width	V	700 ft	700 ft	700 ft	700 ft
Acres		13.770	13.770	13.770	13.770
<b>RUNWAY SEPARATION</b>					
<i>Runway centerline to:</i>					
Parallel runway centerline	H	<i>Refer to paragraph 316</i>			
Holding Position <sup>7</sup>		200 ft	200 ft	200 ft	250 ft
Parallel taxiway/taxilane centerline <sup>2,4</sup>	D	300 ft	300 ft	300 ft	350 ft
Aircraft parking area	G	400 ft	400 ft	400 ft	400 ft
Helicopter touchdown pad		<i>Refer to AC 150/5390-2</i>			

**Note:**

- Values in the table are rounded to the nearest foot. 1 foot = 0.305 meters.

**Table A7-6. Runway design standards matrix, A/B - IV**

<i>Aircraft Approach Category (AAC) and Airplane Design Group (ADG):</i>		<b>A/B - IV</b>			
<b>ITEM</b>	<b>DIM <sup>1</sup></b>	<b>VISIBILITY MINIMUMS</b>			
		Visual	Not Lower than 1 mile	Not Lower than 3/4 mile	Lower than 3/4 mile
<b>RUNWAY DESIGN</b>					
Runway Length	A	<i>Refer to paragraphs 302 and 304</i>			
Runway Width	B	150 ft	150 ft	150 ft	150 ft
Shoulder Width		25 ft	25 ft	25 ft	25 ft
Blast Pad Width		200 ft	200 ft	200 ft	200 ft
Blast Pad Length		200 ft	200 ft	200 ft	200 ft
Crosswind Component		20 knots	20 knots	20 knots	20 knots
<b>RUNWAY PROTECTION</b>					
Runway Safety Area (RSA)					
Length beyond departure end <sup>9,10</sup>	R	1,000 ft	1,000 ft	1,000 ft	1,000 ft
Length prior to threshold <sup>11</sup>	P	600 ft	600 ft	600 ft	600 ft
Width	C	500 ft	500 ft	500 ft	500 ft
Runway Object Free Area (ROFA)					
Length beyond runway end	R	1,000 ft	1,000 ft	1,000 ft	1,000 ft
Length prior to threshold <sup>11</sup>	P	600 ft	600 ft	600 ft	600 ft
Width	Q	800 ft	800 ft	800 ft	800 ft
Runway Obstacle Free Zone (ROFZ)					
Length		<i>Refer to paragraph 308</i>			
Width		<i>Refer to paragraph 308</i>			
Precision Obstacle Free Zone (POFZ)					
Length		N/A	N/A	N/A	200 ft
Width		N/A	N/A	N/A	800 ft
Approach Runway Protection Zone (RPZ)					
Length	L	1,000 ft	1,000 ft	1,700 ft	2,500 ft
Inner Width	U	500 ft	500 ft	1,000 ft	1,000 ft
Outer Width	V	700 ft	700 ft	1,510 ft	1,750 ft
Acres		13.770	13.770	48.978	78.914
Departure Runway Protection Zone (RPZ)					
Length	L	1,000 ft	1,000 ft	1,000 ft	1,000 ft
Inner Width	U	500 ft	500 ft	500 ft	500 ft
Outer Width	V	700 ft	700 ft	700 ft	700 ft
Acres		13.770	13.770	13.770	13.770
<b>RUNWAY SEPARATION</b>					
<i>Runway centerline to:</i>					
Parallel runway centerline	H	<i>Refer to paragraph 316</i>			
Holding Position <sup>8</sup>		250 ft	250 ft	250 ft	250 ft
Parallel taxiway/taxilane centerline <sup>2</sup>	D	400 ft	400 ft	400 ft	400 ft
Aircraft parking area	G	500 ft	500 ft	500 ft	500 ft
Helicopter touchdown pad		<i>Refer to AC 150/5390-2</i>			

**Note:**

- Values in the table are rounded to the nearest foot. 1 foot = 0.305 meters.



**Table A7-7. Runway design standards matrix, C/D/E - I**

<i>Aircraft Approach Category (AAC) and Airplane Design Group (ADG):</i>		<b>C/D/E - I</b>			
<b>ITEM</b>	<b>DIM <sup>1</sup></b>	<b>VISIBILITY MINIMUMS</b>			
		Visual	Not Lower than 1 mile	Not Lower than 3/4 mile	Lower than 3/4 mile
<b>RUNWAY DESIGN</b>					
Runway Length	A	<i>Refer to paragraphs 302 and 304</i>			
Runway Width	B	100 ft	100 ft	100 ft	100 ft
Shoulder Width		10 ft	10 ft	10 ft	10 ft
Blast Pad Width		120 ft	120 ft	120 ft	120 ft
Blast Pad Length		100 ft	100 ft	100 ft	100 ft
Crosswind Component		16 knots	16 knots	16 knots	16 knots
<b>RUNWAY PROTECTION</b>					
Runway Safety Area (RSA)					
Length beyond departure end <sup>9,10</sup>	R	1,000 ft	1,000 ft	1,000 ft	1,000 ft
Length prior to threshold <sup>11</sup>	P	600 ft	600 ft	600 ft	600 ft
Width <sup>13</sup>	C	500 ft	500 ft	500 ft	500 ft
Runway Object Free Area (ROFA)					
Length beyond runway end	R	1,000 ft	1,000 ft	1,000 ft	1,000 ft
Length prior to threshold <sup>11</sup>	P	600 ft	600 ft	600 ft	600 ft
Width	Q	800 ft	800 ft	800 ft	800 ft
Runway Obstacle Free Zone (ROFZ)					
Length		<i>Refer to paragraph 308</i>			
Width		<i>Refer to paragraph 308</i>			
Precision Obstacle Free Zone (POFZ)					
Length		N/A	N/A	N/A	200 ft
Width		N/A	N/A	N/A	800 ft
Approach Runway Protection Zone (RPZ)					
Length	L	1,700 ft	1,700 ft	1,700 ft	2,500 ft
Inner Width	U	500 ft	500 ft	1,000 ft	1,000 ft
Outer Width	V	1,010 ft	1,010 ft	1,510 ft	1,750 ft
Acres		29.465	29.465	48.978	78.914
Departure Runway Protection Zone (RPZ)					
Length	L	1,700 ft	1,700 ft	1,700 ft	1,700 ft
Inner Width	U	500 ft	500 ft	500 ft	500 ft
Outer Width	V	1,010 ft	1,010 ft	1,010 ft	1,010 ft
Acres		29.465	29.465	29.465	29.465
<b>RUNWAY SEPARATION</b>					
<i>Runway centerline to:</i>					
Parallel runway centerline	H	<i>Refer to paragraph 316</i>			
Holding Position		250 ft	250 ft	250 ft	250 ft
Parallel taxiway/taxilane centerline <sup>2</sup>	D	300 ft	300 ft	300 ft	400 ft
Aircraft parking area	G	400 ft	400 ft	400 ft	500 ft
Helicopter touchdown pad		<i>Refer to AC 150/5390-2</i>			

**Note:**

- Values in the table are rounded to the nearest foot. 1 foot = 0.305 meters.

**Table A7-8. Runway design standards matrix, C/D/E - II**

<i>Aircraft Approach Category (AAC) and Airplane Design Group (ADG):</i>		<b>C/D/E - II</b>			
<b>ITEM</b>	<b>DIM <sup>1</sup></b>	<b>VISIBILITY MINIMUMS</b>			
		Visual	Not Lower than 1 mile	Not Lower than 3/4 mile	Lower than 3/4 mile
<b>RUNWAY DESIGN</b>					
Runway Length	A	<i>Refer to paragraphs 302 and 304</i>			
Runway Width	B	100 ft	100 ft	100 ft	100 ft
Shoulder Width		10 ft	10 ft	10 ft	10 ft
Blast Pad Width		120 ft	120 ft	120 ft	120 ft
Blast Pad Length		150 ft	150 ft	150 ft	150 ft
Crosswind Component		16 knots	16 knots	16 knots	16 knots
<b>RUNWAY PROTECTION</b>					
Runway Safety Area (RSA)					
Length beyond departure end <sup>9,10</sup>	R	1,000 ft	1,000 ft	1,000 ft	1,000 ft
Length prior to threshold <sup>11</sup>	P	600 ft	600 ft	600 ft	600 ft
Width <sup>13</sup>	C	500 ft	500 ft	500 ft	500 ft
Runway Object Free Area (ROFA)					
Length beyond runway end	R	1,000 ft	1,000 ft	1,000 ft	1,000 ft
Length prior to threshold <sup>11</sup>	P	600 ft	600 ft	600 ft	600 ft
Width	Q	800 ft	800 ft	800 ft	800 ft
Runway Obstacle Free Zone (ROFZ)					
Length		<i>Refer to paragraph 308</i>			
Width		<i>Refer to paragraph 308</i>			
Precision Obstacle Free Zone (POFZ)					
Length		N/A	N/A	N/A	200 ft
Width		N/A	N/A	N/A	800 ft
Approach Runway Protection Zone (RPZ)					
Length	L	1,700 ft	1,700 ft	1,700 ft	2,500 ft
Inner Width	U	500 ft	500 ft	1,000 ft	1,000 ft
Outer Width	V	1,010 ft	1,010 ft	1,510 ft	1,750 ft
Acres		29.465	29.465	48.978	78.914
Departure Runway Protection Zone (RPZ)					
Length	L	1,700 ft	1,700 ft	1,700 ft	1,700 ft
Inner Width	U	500 ft	500 ft	500 ft	500 ft
Outer Width	V	1,010 ft	1,010 ft	1,010 ft	1,010 ft
Acres		29.465	29.465	29.465	29.465
<b>RUNWAY SEPARATION</b>					
<i>Runway centerline to:</i>					
Parallel runway centerline	H	<i>Refer to paragraph 316</i>			
Holding Position		250 ft	250 ft	250 ft	250 ft
Parallel taxiway/taxilane centerline <sup>2</sup>	D	300 ft	300 ft	300 ft	400 ft
Aircraft parking area	G	400 ft	400 ft	400 ft	500 ft
Helicopter touchdown pad		<i>Refer to AC 150/5390-2</i>			

**Note:**

- Values in the table are rounded to the nearest foot. 1 foot = 0.305 meters.

**Table A7-9. Runway design standards matrix, C/D/E - III**

<i>Aircraft Approach Category (AAC) and Airplane Design Group (ADG):</i>		<b>C/D/E - III</b>			
<b>ITEM</b>	<b>DIM <sup>1</sup></b>	<b>VISIBILITY MINIMUMS</b>			
		Visual	Not Lower than 1 mile	Not Lower than 3/4 mile	Lower than 3/4 mile
<b>RUNWAY DESIGN</b>					
Runway Length	A	<i>Refer to paragraphs 302 and 304</i>			
Runway Width <sup>12</sup>	B	150 ft	150 ft	150 ft	150 ft
Shoulder Width <sup>12</sup>		25 ft	25 ft	25 ft	25 ft
Blast Pad Width <sup>12</sup>		200 ft	200 ft	200 ft	200 ft
Blast Pad Length		200 ft	200 ft	200 ft	200 ft
Crosswind Component		16 knots	16 knots	16 knots	16 knots
<b>RUNWAY PROTECTION</b>					
Runway Safety Area (RSA)					
Length beyond departure end <sup>9, 10</sup>	R	1,000 ft	1,000 ft	1,000 ft	1,000 ft
Length prior to threshold <sup>11</sup>	P	600 ft	600 ft	600 ft	600 ft
Width	C	500 ft	500 ft	500 ft	500 ft
Runway Object Free Area (ROFA)					
Length beyond runway end	R	1,000 ft	1,000 ft	1,000 ft	1,000 ft
Length prior to threshold <sup>11</sup>	P	600 ft	600 ft	600 ft	600 ft
Width	Q	800 ft	800 ft	800 ft	800 ft
Runway Obstacle Free Zone (ROFZ)					
Length		<i>Refer to paragraph 308</i>			
Width		<i>Refer to paragraph 308</i>			
Precision Obstacle Free Zone (POFZ)					
Length		N/A	N/A	N/A	200 ft
Width		N/A	N/A	N/A	800 ft
Approach Runway Protection Zone (RPZ)					
Length	L	1,700 ft	1,700 ft	1,700 ft	2,500 ft
Inner Width	U	500 ft	500 ft	1,000 ft	1,000 ft
Outer Width	V	1,010 ft	1,010 ft	1,510 ft	1,750 ft
Acres		29.465	29.465	48.978	78.914
Departure Runway Protection Zone (RPZ)					
Length	L	1,700 ft	1,700 ft	1,700 ft	1,700 ft
Inner Width	U	500 ft	500 ft	500 ft	500 ft
Outer Width	V	1,010 ft	1,010 ft	1,010 ft	1,010 ft
Acres		29.465	29.465	29.465	29.465
<b>RUNWAY SEPARATION</b>					
<i>Runway centerline to:</i>					
Parallel runway centerline	H	<i>Refer to paragraph 316</i>			
Holding Position <sup>8</sup>		250 ft	250 ft	250 ft	250 ft
Parallel taxiway/taxilane centerline <sup>2</sup>	D	400 ft	400 ft	400 ft	400 ft
Aircraft parking area	G	500 ft	500 ft	500 ft	500 ft
Helicopter touchdown pad		<i>Refer to AC 150/5390-2</i>			

**Note:**

- Values in the table are rounded to the nearest foot. 1 foot = 0.305 meters.

**Table A7-10. Runway design standards matrix, C/D/E - IV**

<i>Aircraft Approach Category (AAC) and Airplane Design Group (ADG):</i>		<b>C/D/E - IV</b>			
<b>ITEM</b>	<b>DIM <sup>1</sup></b>	<b>VISIBILITY MINIMUMS</b>			
		Visual	Not Lower than 1 mile	Not Lower than 3/4 mile	Lower than 3/4 mile
<b>RUNWAY DESIGN</b>					
Runway Length	A	<i>Refer to paragraphs 302 and 304</i>			
Runway Width	B	150 ft	150 ft	150 ft	150 ft
Shoulder Width		25 ft	25 ft	25 ft	25 ft
Blast Pad Width		200 ft	200 ft	200 ft	200 ft
Blast Pad Length		200 ft	200 ft	200 ft	200 ft
Crosswind Component		20 knots	20 knots	20 knots	20 knots
<b>RUNWAY PROTECTION</b>					
Runway Safety Area (RSA)					
Length beyond departure end <sup>9,10</sup>	R	1,000 ft	1,000 ft	1,000 ft	1,000 ft
Length prior to threshold <sup>11</sup>	P	600 ft	600 ft	600 ft	600 ft
Width	C	500 ft	500 ft	500 ft	500 ft
Runway Object Free Area (ROFA)					
Length beyond runway end	R	1,000 ft	1,000 ft	1,000 ft	1,000 ft
Length prior to threshold <sup>11</sup>	P	600 ft	600 ft	600 ft	600 ft
Width	Q	800 ft	800 ft	800 ft	800 ft
Runway Obstacle Free Zone (ROFZ)					
Length		<i>Refer to paragraph 308</i>			
Width		<i>Refer to paragraph 308</i>			
Precision Obstacle Free Zone (POFZ)					
Length		N/A	N/A	N/A	200 ft
Width		N/A	N/A	N/A	800 ft
Approach Runway Protection Zone (RPZ)					
Length	L	1,700 ft	1,700 ft	1,700 ft	2,500 ft
Inner Width	U	500 ft	500 ft	1,000 ft	1,000 ft
Outer Width	V	1,010 ft	1,010 ft	1,510 ft	1,750 ft
Acres		29.465	29.465	48.978	78.914
Departure Runway Protection Zone (RPZ)					
Length	L	1,700 ft	1,700 ft	1,700 ft	1,700 ft
Inner Width	U	500 ft	500 ft	500 ft	500 ft
Outer Width	V	1,010 ft	1,010 ft	1,010 ft	1,010 ft
Acres		29.465	29.465	29.465	29.465
<b>RUNWAY SEPARATION</b>					
<i>Runway centerline to:</i>					
Parallel runway centerline	H	<i>Refer to paragraph 316</i>			
Holding Position <sup>8</sup>		250 ft	250 ft	250 ft	250 ft
Parallel taxiway/taxilane centerline <sup>2</sup>	D	400 ft	400 ft	400 ft	400 ft
Aircraft parking area	G	500 ft	500 ft	500 ft	500 ft
Helicopter touchdown pad		<i>Refer to AC 150/5390-2</i>			

**Note:**

- Values in the table are rounded to the nearest foot. 1 foot = 0.305 meters.

**Table A7-11. Runway design standards matrix, C/D/E - V**

<i>Aircraft Approach Category (AAC) and Airplane Design Group (ADG):</i>		<b>C/D/E - V</b>			
<b>ITEM</b>	<b>DIM <sup>1</sup></b>	<b>VISIBILITY MINIMUMS</b>			
		Visual	Not Lower than 1 mile	Not Lower than 3/4 mile	Lower than 3/4 mile
<b>RUNWAY DESIGN</b>					
Runway Length	A	<i>Refer to paragraphs 302 and 304</i>			
Runway Width	B	150 ft	150 ft	150 ft	150 ft
Shoulder Width		35 ft	35 ft	35 ft	35 ft
Blast Pad Width		220 ft	220 ft	220 ft	220 ft
Blast Pad Length		400 ft	400 ft	400 ft	400 ft
Crosswind Component		20 knots	20 knots	20 knots	20 knots
<b>RUNWAY PROTECTION</b>					
<b>Runway Safety Area (RSA)</b>					
Length beyond departure end <sup>9,10</sup>	R	1,000 ft	1,000 ft	1,000 ft	1,000 ft
Length prior to threshold <sup>11</sup>	P	600 ft	600 ft	600 ft	600 ft
Width	C	500 ft	500 ft	500 ft	500 ft
<b>Runway Object Free Area (ROFA)</b>					
Length beyond runway end	R	1,000 ft	1,000 ft	1,000 ft	1,000 ft
Length prior to threshold <sup>11</sup>	P	600 ft	600 ft	600 ft	600 ft
Width	Q	800 ft	800 ft	800 ft	800 ft
<b>Runway Obstacle Free Zone (ROFZ)</b>					
Length		<i>Refer to paragraph 308</i>			
Width		<i>Refer to paragraph 308</i>			
<b>Precision Obstacle Free Zone (POFZ)</b>					
Length		N/A	N/A	N/A	200 ft
Width		N/A	N/A	N/A	800 ft
<b>Approach Runway Protection Zone (RPZ)</b>					
Length	L	1,700 ft	1,700 ft	1,700 ft	2,500 ft
Inner Width	U	500 ft	500 ft	1,000 ft	1,000 ft
Outer Width	V	1,010 ft	1,010 ft	1,510 ft	1,750 ft
Acres		29.465	29.465	48.978	78.914
<b>Departure Runway Protection Zone (RPZ)</b>					
Length	L	1,700 ft	1,700 ft	1,700 ft	1,700 ft
Inner Width	U	500 ft	500 ft	500 ft	500 ft
Outer Width	V	1,010 ft	1,010 ft	1,010 ft	1,010 ft
Acres		29.465	29.465	29.465	29.465
<b>RUNWAY SEPARATION</b>					
<i>Runway centerline to:</i>					
Parallel runway centerline	H	<i>Refer to paragraph 316</i>			
Holding Position <sup>8</sup>		250 ft	250 ft	250 ft	280 ft
Parallel taxiway/taxilane centerline <sup>3,5</sup>	D	<i>See footnote 3.</i>			
Aircraft parking area	G	500 ft	500 ft	500 ft	500 ft
Helicopter touchdown pad		<i>Refer to AC 150/5390-2</i>			

**Note:**

- Values in the table are rounded to the nearest foot. 1 foot = 0.305 meters.

**Table A7-12. Runway design standards matrix, C/D/E - VI**

<i>Aircraft Approach Category (AAC) and Airplane Design Group (ADG):</i>		<b>C/D/E - VI</b>			
<b>ITEM</b>	<b>DIM <sup>1</sup></b>	<b>VISIBILITY MINIMUMS</b>			
		Visual	Not Lower than 1 mile	Not Lower than 3/4 mile	Lower than 3/4 mile
<b>RUNWAY DESIGN</b>					
Runway Length	A	<i>Refer to paragraphs 302 and 304</i>			
Runway Width	B	200 ft	200 ft	200 ft	200 ft
Shoulder Width		40 ft	40 ft	40 ft	40 ft
Blast Pad Width		280 ft	280 ft	280 ft	280 ft
Blast Pad Length		400 ft	400 ft	400 ft	400 ft
Crosswind Component		20 knots	20 knots	20 knots	20 knots
<b>RUNWAY PROTECTION</b>					
Runway Safety Area (RSA)					
Length beyond departure end <sup>9,10</sup>	R	1,000 ft	1,000 ft	1,000 ft	1,000 ft
Length prior to threshold <sup>11</sup>	P	600 ft	600 ft	600 ft	600 ft
Width	C	500 ft	500 ft	500 ft	500 ft
Runway Object Free Area (ROFA)					
Length beyond runway end	R	1,000 ft	1,000 ft	1,000 ft	1,000 ft
Length prior to threshold <sup>11</sup>	P	600 ft	600 ft	600 ft	600 ft
Width	Q	800 ft	800 ft	800 ft	800 ft
Runway Obstacle Free Zone (ROFZ)					
Length		<i>Refer to paragraph 308</i>			
Width		<i>Refer to paragraph 308</i>			
Precision Obstacle Free Zone (POFZ)					
Length		N/A	N/A	N/A	200 ft
Width		N/A	N/A	N/A	800 ft
Approach Runway Protection Zone (RPZ)					
Length	L	1,700 ft	1,700 ft	1,700 ft	2,500 ft
Inner Width	U	500 ft	500 ft	1,000 ft	1,000 ft
Outer Width	V	1,010 ft	1,010 ft	1,510 ft	1,750 ft
Acres		29.465	29.465	48.978	78.914
Departure Runway Protection Zone (RPZ)					
Length	L	1,700 ft	1,700 ft	1,700 ft	1,700 ft
Inner Width	U	500 ft	500 ft	500 ft	500 ft
Outer Width	V	1,010 ft	1,010 ft	1,010 ft	1,010 ft
Acres		29.465	29.465	29.465	29.465
<b>RUNWAY SEPARATION</b>					
<i>Runway centerline to:</i>					
Parallel runway centerline	H	<i>Refer to paragraph 316</i>			
Holding Position <sup>8</sup>		280 ft	280 ft	280 ft	280 ft
Parallel taxiway/taxilane centerline <sup>2,6</sup>	D	500 ft	500 ft	500 ft	500 ft
Aircraft parking area	G	500 ft	500 ft	500 ft	500 ft
Helicopter touchdown pad		<i>Refer to AC 150/5390-2</i>			

**Note:**

- Values in the table are rounded to the nearest foot. 1 foot = 0.305 meters.

**Footnotes:**

1. Letters correspond to the dimensions in Figure 3-26.
2. The runway to taxiway/taxilane centerline separation standards are for sea level. At higher elevations, an increase to these separation distances may be required to keep taxiing and holding aircraft clear of the inner-transitional OFZ (refer to paragraph 308.c). Using this standard to justify a decrease in runway to taxiway/taxilane separation is not permitted.
3. The standard runway centerline to parallel taxiway centerline separation distance is 400 feet for airports at or below an elevation of 1,345 feet; 450 feet for airports between elevations of 1,345 feet and 6,560 feet; and 500 feet for airports above an elevation of 6,560 feet.
4. For approaches with visibility less than ½-statute mile, runway centerline to taxiway/taxilane centerline separation increases to 400 feet.
5. For approaches with visibility less than ½-statute mile, the separation distance increases to 500 feet.
6. For approaches with visibility less than ¾ statute mile, the separation distance may increase by an elevation adjustment. For approaches with visibility less than ½-statute mile, the separation distance increases to 550 feet.
7. This distance is increased 1 foot for each 100 feet above 5,100 feet above sea level.
8. This distance is increased 1 foot for each 100 feet above sea level.
9. The RSA length beyond the runway end begins at the runway end when a stopway is not provided. When a stopway is provided, the length begins at the stopway end.
10. The RSA length beyond the runway end may be reduced to that required to install an Engineered Materials Arresting System (EMAS) (the designed set-back of the EMAS included) designed to stop the design aircraft exiting the runway end at 70 knots.
11. This value only applies if that runway end is equipped with electronic or visual vertical guidance. If visual guidance is not provided, use the value for “length beyond departure end.”
12. For airplanes with maximum certificated takeoff weight of 150,000 lbs or less, the standard runway width is 100 feet, the shoulder width is 20 feet, and the runway blast pad width is 140 feet.
13. An RSA width of 400 feet is permissible.

**Page intentionally left blank.**



## Appendix 8. Taxiway Fillet Design

### A8-1. Description.

As an airplane negotiates a turn designed for cockpit over centerline taxiing, the main gear require additional pavement in the form of fillets to maintain the Taxiway Edge Safety Margin (TESM). The fillets are designed based on combinations of the longest CMGs and widest MGWs in the TDG. The outer radius of the curve is designed based on combinations of the shortest CMGs and widest MGWs in the TDG. The nose gear is not a factor in pavement requirements for a taxiway turn. The TDG critical boundary points of all lower TDGs need to be checked. The MGW-CMG combinations necessary for design are provided in [Table 4-11](#) and illustrated in [Figure 4-16](#).

### A8-2. Dimensions.

The following refers to [Figure A8-1](#). At the start of the turn, the taxiway is widened on the inside of the turn for a length  $L-1$ , with the distance from the taxiway centerline to the pavement edge tapering from  $W-0$  to  $W-1$ . As the airplane continues, the distance from the taxiway centerline to the pavement edge taper must be increased further, for a length  $L-2$ , from  $W-1$  to  $W-2$ , ending at a distance  $L-3$  from the point of intersection. The tapers associated with the dimensions  $L-1$  and  $L-2$  are symmetrical about a line bisecting the angle between the two centerlines, and the “ $L-2$ ” tapers are connected by a fillet of radius  $R$ -Fillet, tangent to both.

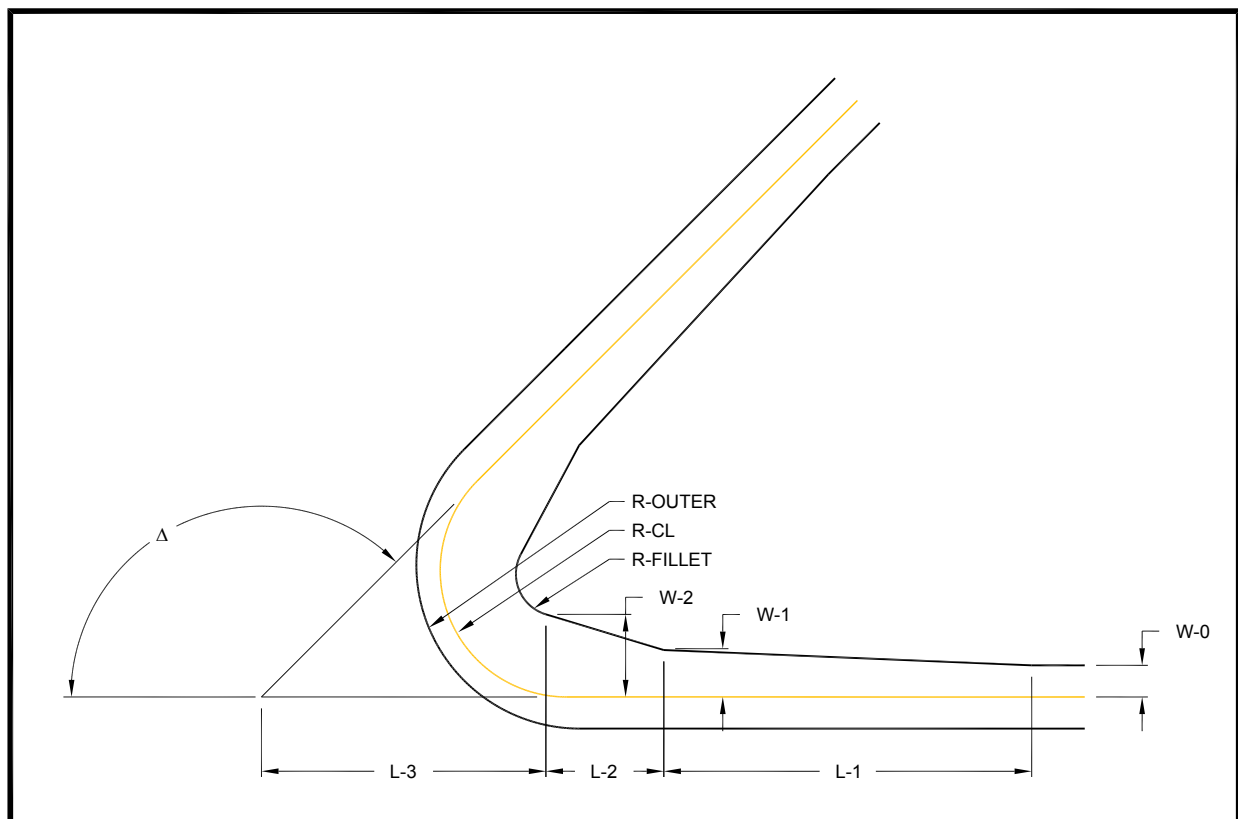


Figure A8-1. Fillet design example

These dimensions are actually controlled by the track of the main gear as the airplane exits the turn and the main gear slowly return to a symmetrical track about the taxiway centerline. Since the main gear follow an asymptotic curve, the airplane theoretically never becomes re-centered. Practically, it can take over 1000 ft (305 m) for the airplane to become re-centered. For this reason, the end of the “L-1” taper is based on a TESM 6 inches (15 cm) less than the applicable standard.

### **A8-3. Transitions.**

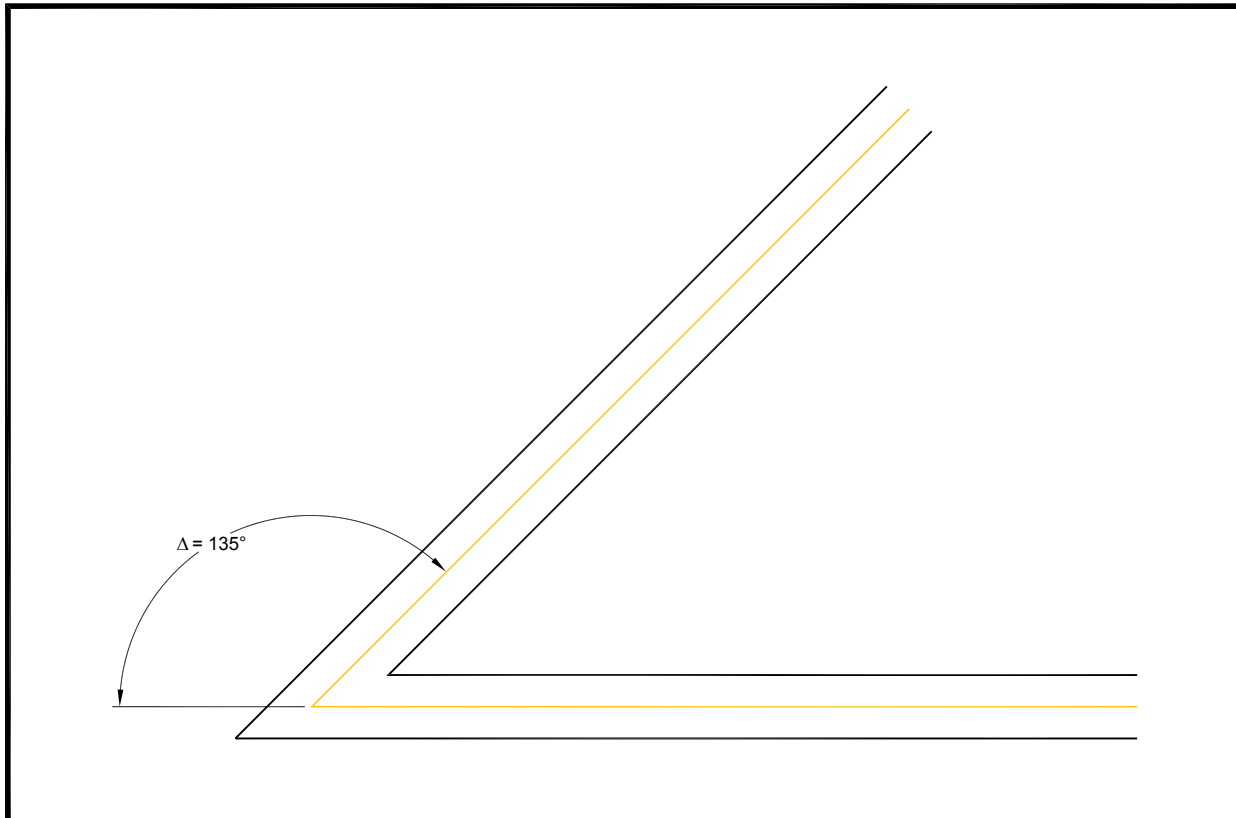
The transition point from “L-1” taper to the “L-2” taper is arbitrary, and should be chosen based on minimizing excess pavement, maximizing constructability, and compatibility with taxiway edge lighting standards. W-1 is determined by the location of this transition point.

**a.** When designing taxiway intersections using standard angles (deltas) and sufficient lead-in lengths, dimensions may be taken from Table 4-3 and the subsequent seven tables representing TDG 1A, 1B, etc., respectively. However, where taxiway turns are close together, such that the “L-1” tapers overlap, this is an indication that the design airplane would not fully straighten before beginning the second turn. This often is the case for 90-degree runway entrances and exits. In such cases, the standard fillet dimensions may not be adequate to maintain the TESM and/or a maximum 50-degree nose gear steering angle. Some common combinations of TDG and taxiway to taxiway separation, and TDG and runway to taxiway separation are shown in Table 4-12, Table 4-14, and Table 4-15. For separation distances and turns not listed in the standard tables, selecting the centerline turn radius, outer pavement and fillet dimensions will require CAD modeling.

**b.** Design tools. Microsoft Excel spreadsheets that can be used to determine the required radius and taper lengths for single turns and two closely space turns are available on the FAA web site at: [http://www.faa.gov/airports/engineering/airport\\_design/](http://www.faa.gov/airports/engineering/airport_design/).

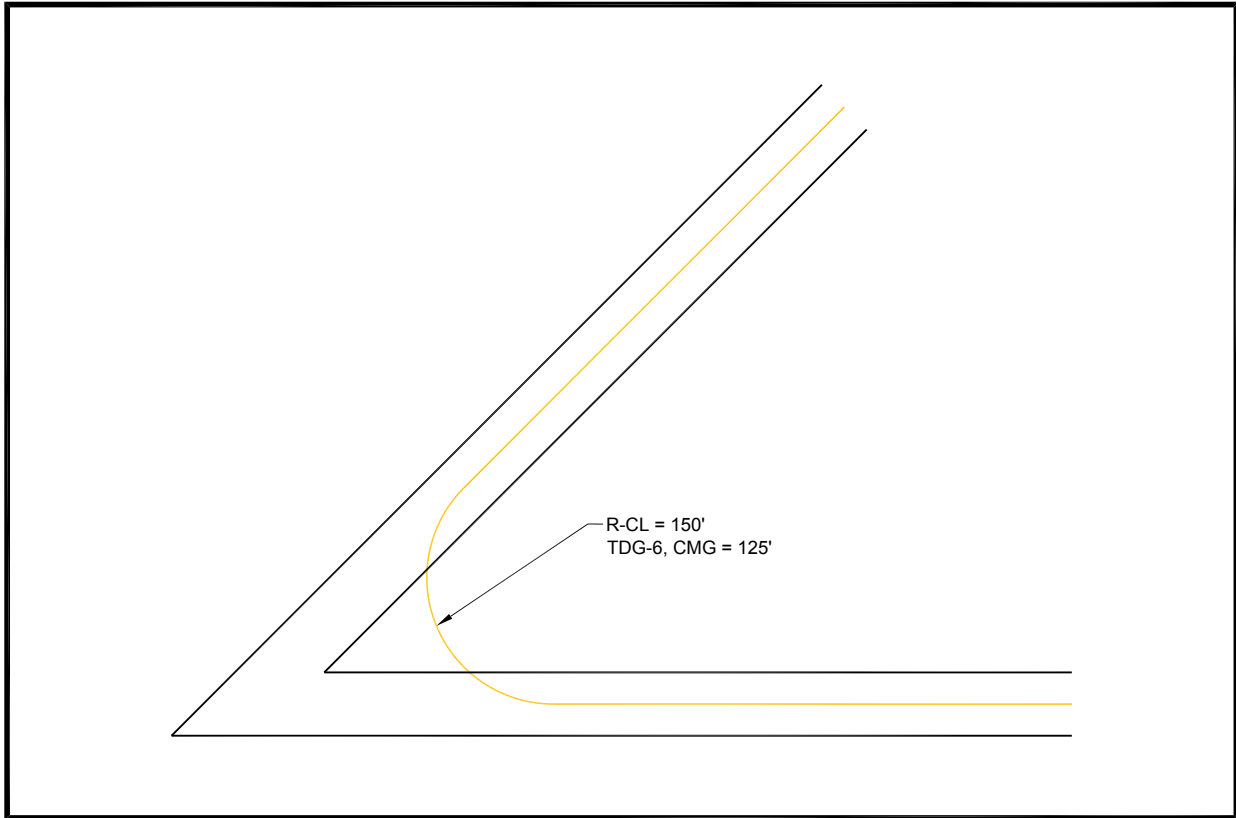
**c.** See Figure A8-2 through Figure A8-10 for an example of a curve design using CAD modeling of aircraft ground maneuvering.

In Figure A8-2, the angle of intersection (delta) is chosen. This example illustrates the design of a curve for a delta of 135 degrees for TDG-6.



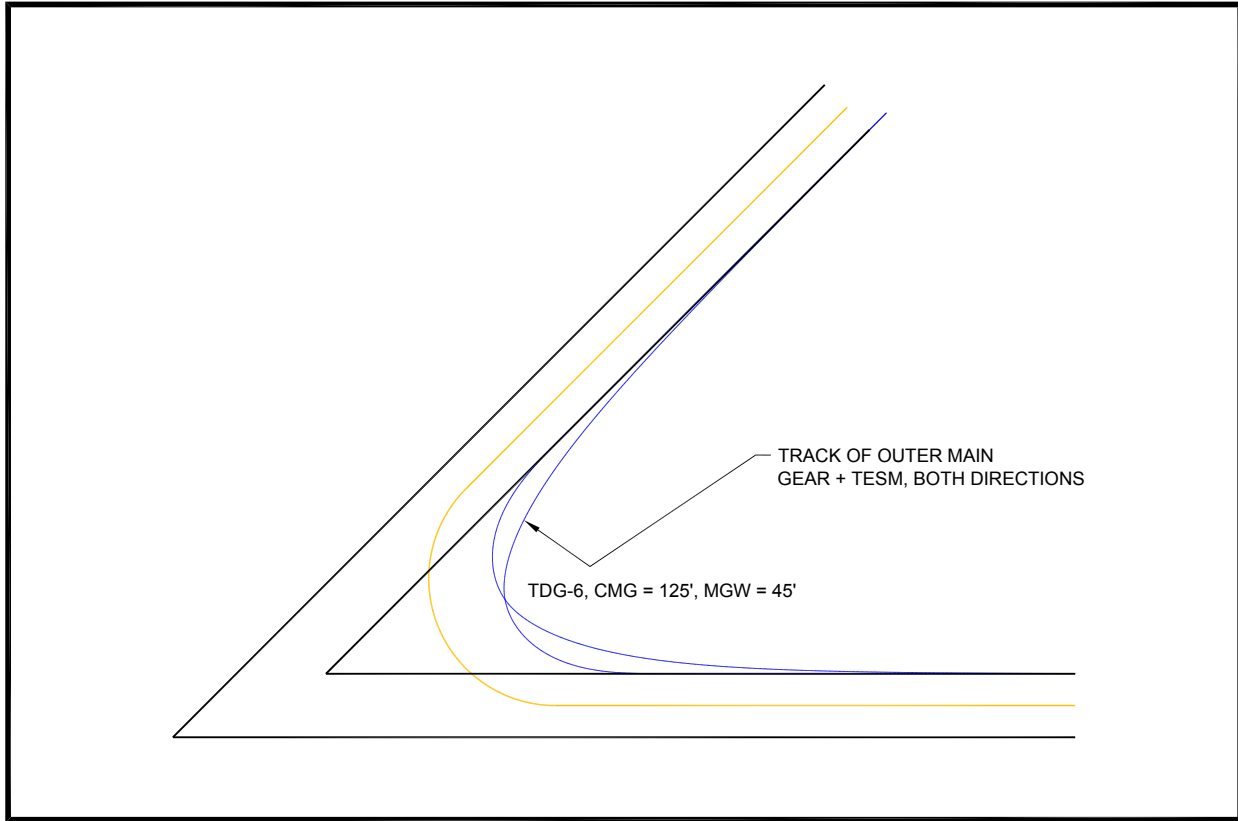
**Figure A8-2. Angle of intersection (delta)**

In Figure A8-3, the two centerlines are connected by a radius calculated to result in a steering angle of no more than 50 degrees based on the maximum CMG of the TDG. For TDG-6, the maximum CMG is 125 feet.



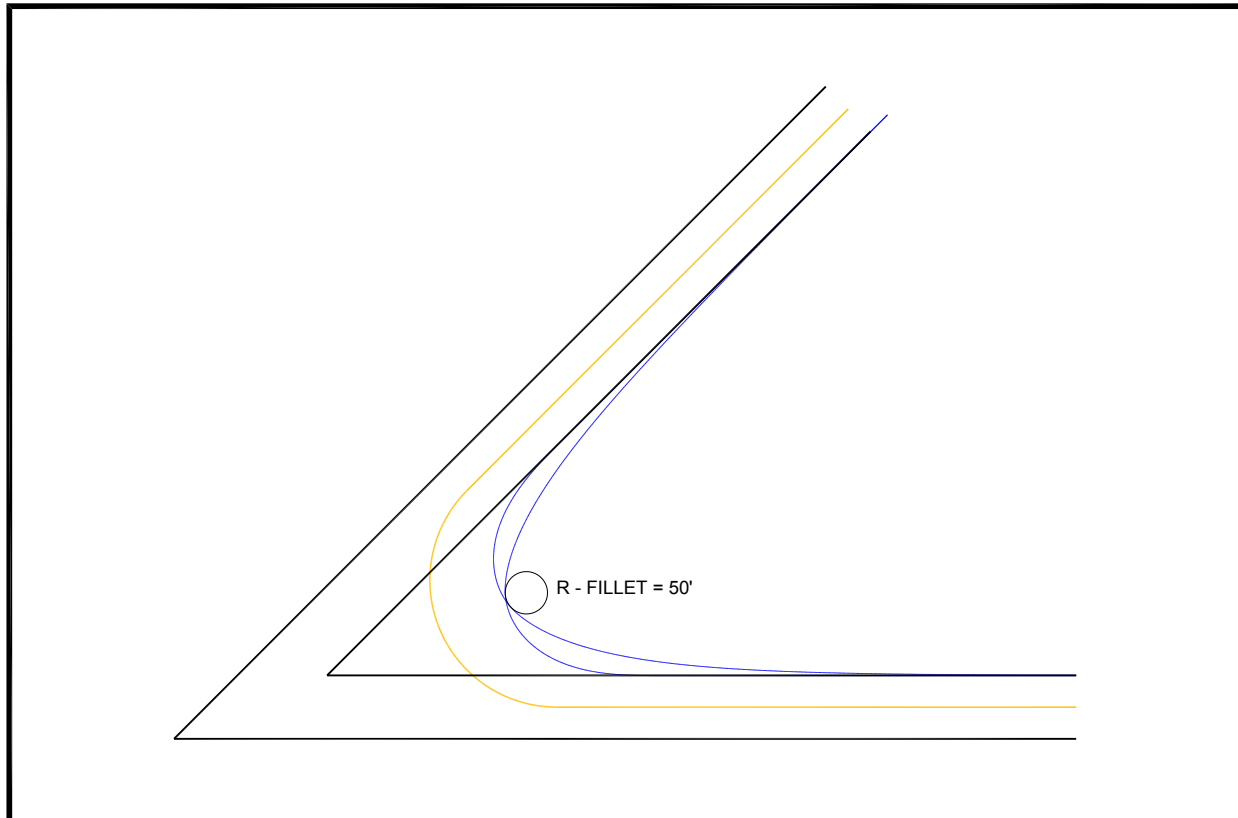
**Figure A8-3. Steering angle of no more than 50 degrees**

In Figure A8-4, the track of the main gear of the longest CMG, widest MGW is modeled, offset by the TESM. For TDG-6, the TESM = 15 feet.



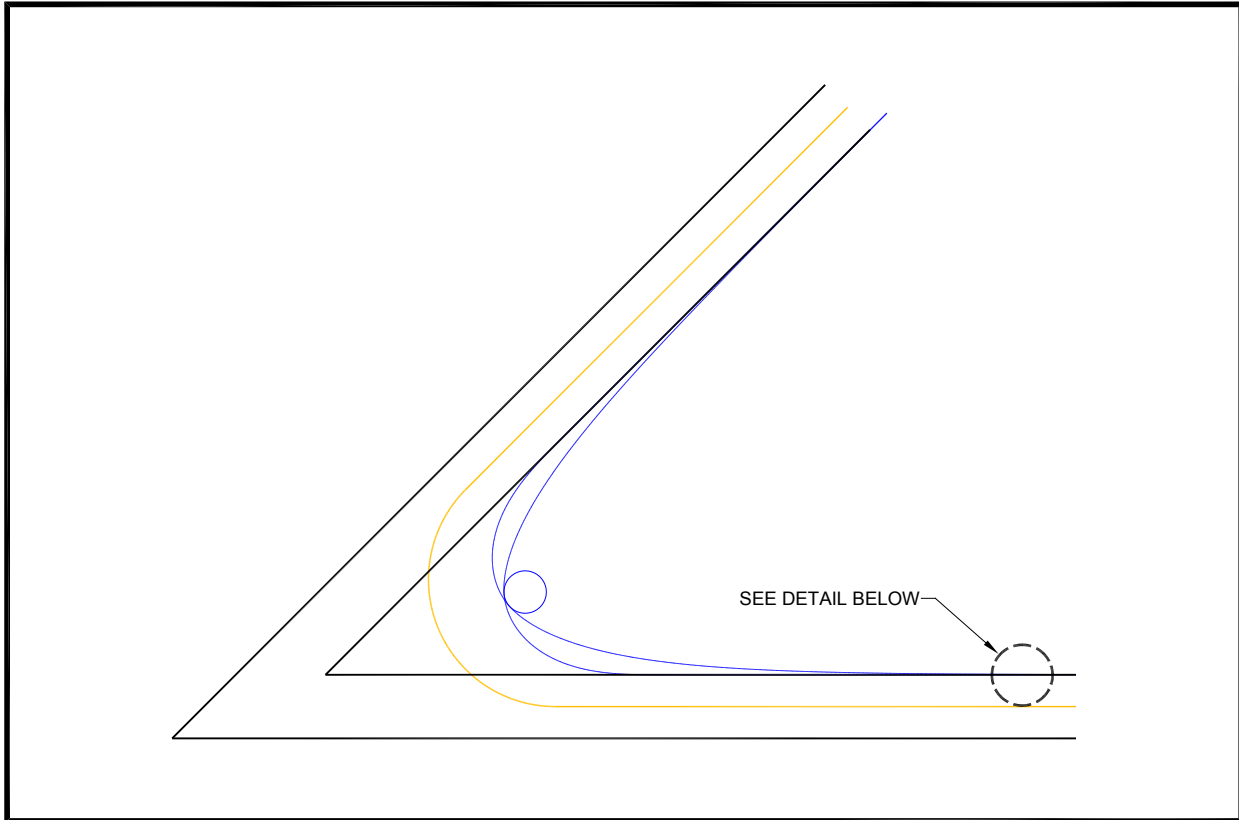
**Figure A8-4. Track of the main gear is modeled, offset by the TESM**

In Figure A8-5, a fillet radius is chosen to minimize excess pavement while providing the required TESM. In this example, R-FILLET = 50 feet is chosen.



**Figure A8-5. Minimize excess pavement while providing the required TESM**

In Figure A8-6, the pavement edge (or main gear track + TESM) is offset by 6 inches (15 cm), for the purposes of determining the intersection between the main gear track and the pavement edge. Either method may be used to apply the 6-inch reduction in TESM noted in paragraph 406.b(2).



**Figure A8-6. Pavement edge (main gear track + TESM) offset by 6 inches (15 cm)**

Figure A8-7 shows a detail of this point. Offsetting either the actual pavement edge or the gear track plus TESM for the purposes of calculating this point recognizes the asymptotic nature of an airplane aligning with the taxiway centerline upon exiting a turn, as noted in paragraph 406.b(2).

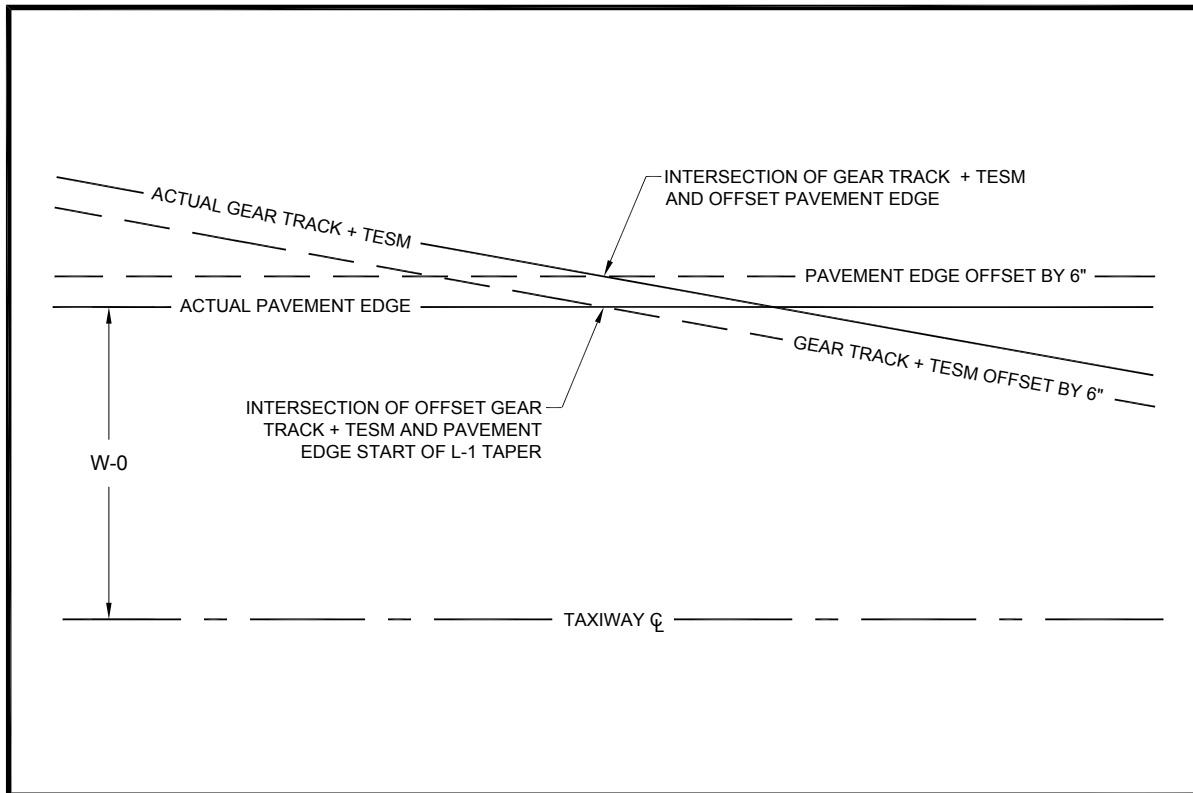
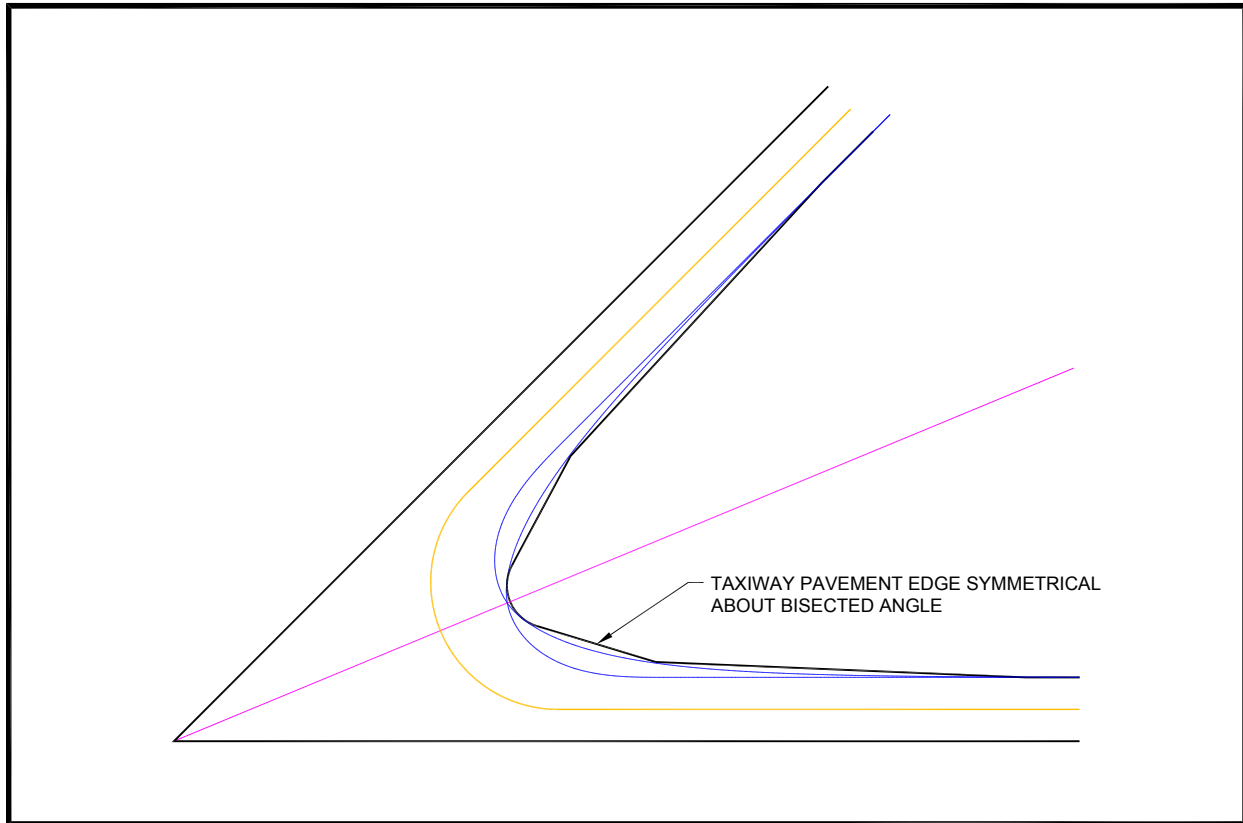


Figure A8-7. Detail of Figure A8-6

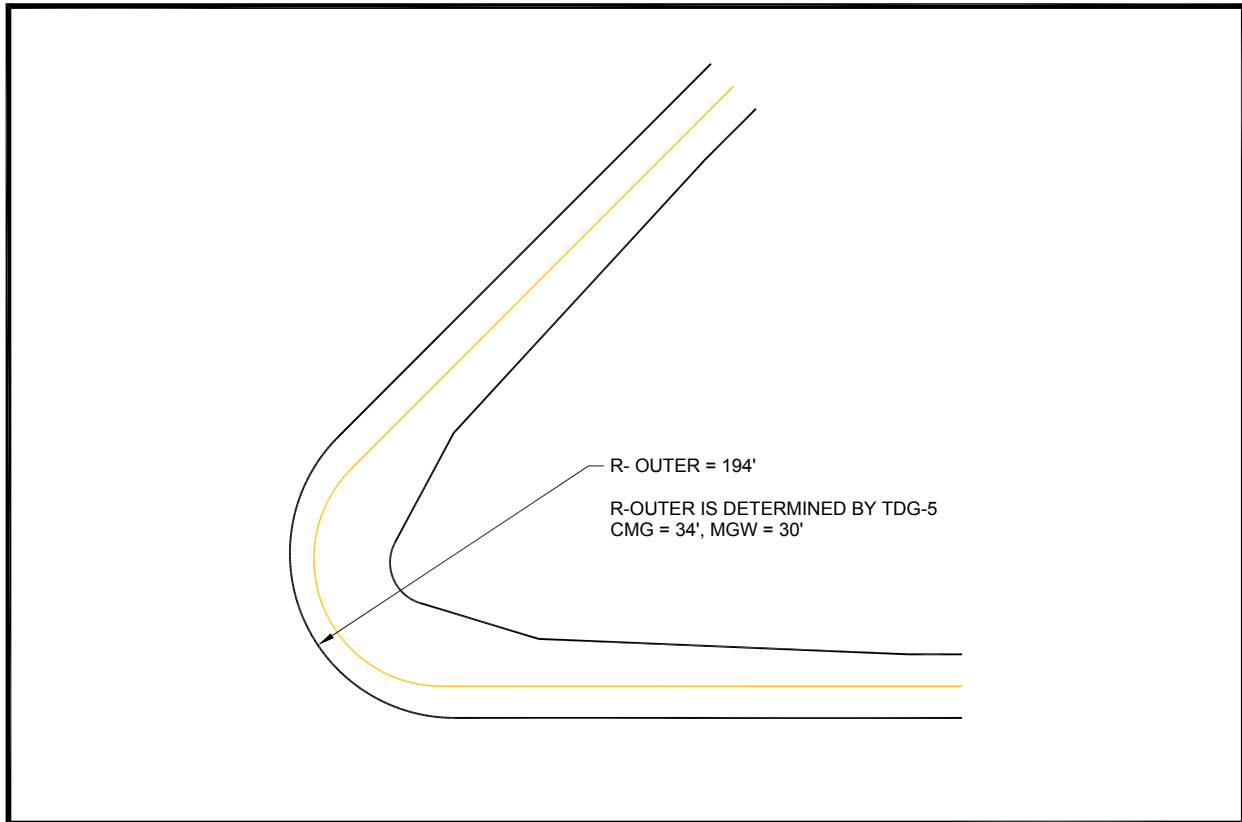


In Figure A8-8, tapers are selected to minimize excess pavement while considering constructability. The point of intersection of the tapers determines the dimension W-1.



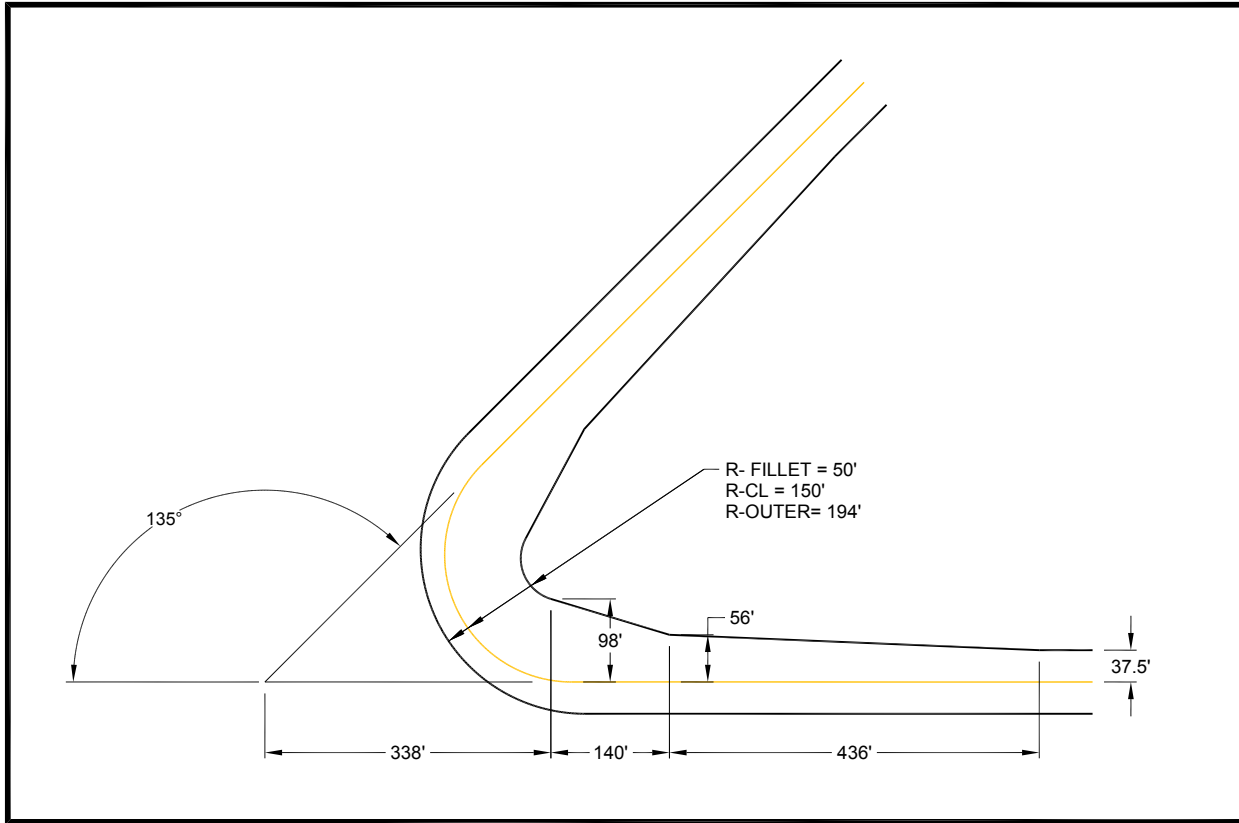
**Figure A8-8. Tapers selected to minimize excess pavement while considering constructability**

In Figure A8-9, the radius of the outer pavement edge is determined based on the minimum CMG and maximum MGW in the design TDG and all lower TDGs. Modeling more than one CMG-MGW-TESM combination may be necessary (see Table 4-11 and Figure 4-16). In this case, the controlling combination of CMG, MGW, and TESSM are those of TDG-5 (CMG=34 feet, MGW=30 feet, TESSM=15 feet).



**Figure A8-9. Radius of outer pavement edge determined based on the minimum CMG and maximum MGW in the TDG**

In Figure A8-10, dimensions are applied to the design.



**Figure A8-10. Dimensions applied to the design**

**Page intentionally left blank.**

**Appendix 9. Acronyms**

A/FD	Airport/Facility Directory
AAA	Airport Airspace Analysis
AAC	Aircraft Approach Category
AAS-100	FAA Office of Airport Safety and Standards, Airport Engineering Division
AASHTO	American Association of State Highway and Transportation Officials
ABN	Airport Beacon
AC	Advisory Circular
ACM	Airport Certification Manual
ACRP	Airport Cooperative Research Program
ADG	Airplane Design Group
ADO	Airports District Office
ADRM	Airport Development Reference Manual
ADS-B	Automatic Dependent Surveillance - Broadcast
AFTIL	Airport Facilities Terminal Integration Laboratory
AGL	Above Ground Level
AIM	Aeronautical Information Manual
AIP	Airport Improvement Program
ALP	Airport Layout Plan
ALS	Approach Lighting System
ALSF	Approach Lighting System with Sequenced Flashing Lights
ALSF-1	ALS with Sequenced Flashers I
ALSF-2	ALS with Sequenced Flashers II
AOA	Aircraft Operations Area
APRC	Approach Reference Code
APV	Approach Procedure with Vertical Guidance
ARC	Airport Reference Code
ARFF	Aircraft Rescue and Fire Fighting
ARP	Airport Reference Point
ARSR	Air Route Surveillance Radar
ASBL	Approach Surface Baseline
ASDA	Accelerate Stop Distance Available
ASDE	Airport Surface Detection Equipment - (Radar)
ASDE-X	Airport Surface Detection Equipment – Model X
ASOS	Automated Surface Observing System
ASR	Airport Surveillance Radar
ASRS	Aviation Safety Reporting System
ASTM	American Society for Testing and Materials International
ATC	Air Traffic Control
ATCBI	Air Traffic Control Beacon Interrogator
ATC-F	Air Traffic Control Facilities
ATCRB	Air Traffic Control Radar Beacon
ATCT	Airport Traffic Control Tower
ATO	Air Traffic Organization

AWOS	Automated Weather Observing Systems
AWSS	Automated Weather Sensor System
BMP	Best Management Practice
BRL	Building Restriction Line
BUEC	Backup Emergency Communication System
CAD	Computer Aided Design
CAT	Category
CFR	Code of Federal Regulations
CIE	International Committee of Illumination
CL	Centerline
CWY	Clearway
CMG	Cockpit to Main Gear Distance
CNSW	Communications, Navigation, Surveillance and Weather
CPA	Continuous Power Airport
DA	Decision Altitude
DER	Departure End of Runway
DF	Direction Finder
DME	Distance Measuring Equipment
DMER	DME Remaining
DOD	Department of Defense
DPRC	Departure Reference Code
EAT	End-Around Taxiway
ECS	Emergency Communication System
EMAS	Engineered Materials Arresting System
ETB	Embedded Threshold Bar
FAA	Federal Aviation Administration
FAR	Federal Aviation Regulations
FATO	Final Approach and Takeoff Area
FBO	Fixed Base Operator
FM	Fan Marker
FOD	Foreign Object Debris
GBT	Ground Based Transceiver
GDL	Guidance Light Facility
GIS	Geographic Information System
GLS	Global Navigation Satellite System (GNSS) Landing System
GNSS	Global Navigation Satellite System
GPA	Glide Path Angle
GPS	Global Positioning System
GQS	Glide Path Qualification Surface
GS	Glideslope
GVGI	Generic Visual Glideslope Indicators
HAA	Height Above Airport
HATh	Height Above Threshold
HIRL	High Intensity Runway Lights
HSS	Hollow Structural Section
HTTP	Hypertext Transfer Protocol

IAP	Instrument Approach Procedures
IATA	International Air Transport Association
IES	Illuminating Engineering Society of North America
IFR	Instrument Flight Rules
IFST	International Flight Service Transmitter
ILS	Instrument Landing System
IM	Inner Marker
LDA	Landing Distance Available
LDIN	Lead-in Lighting System
LIR	Low Impact Resistant
LIRL	Low Intensity Runway Lights
LLWAS	Low Level Windshear Alert System
LMM	Compass Locator at the ILS Middle Marker
LNAV	Lateral Navigation
LOC	Localizer
LOM	Compass Locator at Outer Marker
LOS	Line of Sight
LP	Localizer Performance
LPV	Localizer Performance with Vertical Guidance
MALS	Medium Intensity Approach Lighting System
MALSF	MALS with Sequenced Flashers
MALSR	MALS with Runway Alignment Indicator Lights
MDA	Minimum Descent Altitude
MGW	Main Gear Width
MIRL	Medium Intensity Runway Lights
MM	Middle Marker
MN	Magnetic North
MODES	Mode Select Beacon System
MPH	Miles Per Hour
MSL	Mean Sea Level
MTOW	Maximum Takeoff Weight
NAS	National Airspace System
NAVAID	Navigation Aid
NCDC	National Climatic Data Center
NDB	Non-directional Beacon
NEPA	National Environmental Policy Act
NGS	National Geodetic Survey
NPA	Non-Precision Approach
NPDES	National Pollution Discharge Elimination System
NPIAS	National Plan of Integrated Airport Systems
nT	nanoTesla
NVGS	Non-Vertically Guided Survey
NXRAD	Next Generation Weather Radar
OAW	Off Airways Weather Station
OCS	Obstacle Clearance Surface
ODALS	Omnidirectional Airport Lighting System

OE/AAA	Obstruction Evaluation/Airport Airspace Analysis
OFA	Object Free Area
OFZ	Obstacle Free Zone
OM	Outer Marker
PA	Precision Approach
PAPI	Precision Approach Path Indicator
PAR	Precision Approach Radar
PCN	Pavement Condition Number
PFC	Passenger Facility Charge
PIR	Precision Instrument Runways
POFZ	Precision Obstacle Free Zone
PRM	Precision Runway Monitor
PSI	Pounds per Square Inch
RAIL	Runway Alignment Indicator Lights
RAPT	Regional Airspace Procedures Team
RBPM	Remote Beacon Performance Monitor
RCAG	Remote Communication Air to Ground
RCLR	Radio Communications Link Repeater
RCLT	Radio Communications Link Terminal
RCO	Remote Communications Outlet
RDC	Runway Design Code
REIL	Runway End Identifier Lighting
REL	Runway Entrance Lights
RMLR	Radar Microwave Link Repeater
RMLT	Radar Microwave Link Terminal
RNAV	Area Navigation
RNP	Required Navigation Performance
ROFA	Runway Object Free Area
ROFZ	Runway Obstacle Free Zone
RON	Remain Over Night
RPZ	Runway Protection Zone
RRH	Remote Readout Hygrothermometers
RSA	Runway Safety Area
RTR	Remote Transmitter/Receiver
RVR	Runway Visual Range
RW	Runway
RWSL	Runway Status Lights
SACOM	Satellite Communications Network
SAWS	Stand Alone Weather Sensors
SMS	Safety Management System
SOP	Standard Operating Procedures
SRM	Safety Risk Management
SSALR	Simplified Short Approach Light System with Runway Alignment
SSALS	Simplified Short Approach Light System
SSALF	Simplified Short Approach Light System with Sequenced Flashing Lights
SSO	Self-Sustained Outlet



SWY	Stopway
TACAN	Tactical Air Navigation
TCH	Threshold Crossing Height
TDG	Taxiway Design Group
TDWR	Terminal Doppler Weather Radar
TERPS	Terminal Instrument Procedures
TESM	Taxiway Edge Safety Margin
TH	Threshold
THL	Takeoff Hold Lights
TL	Taxilane
TMLR	Television Microwave Link Repeater
TODA	Takeoff Distance Available
TOFA	Taxiway and Taxilane Object Free Area
TORA	Takeoff Run Available
TRACON	Terminal Radar Approach Control Facility
TSA	Taxiway/Taxilane Safety Area
TSR	Transportation Security Regulation
TSS	Threshold Siting Surface
TVOR	Terminal Very High Frequency Omnidirectional Range
TW	Taxiway
UAS	Unmanned Aircraft Systems
USC	United States Code
UFC	Unified Facilities Criteria
UHF	Ultra-High Frequency
USDA	United States Department of Agriculture
USGS	U.S. Geological Survey
V	Visual
VASI	Visual Approach Slope Indicator
VFR	Visual Flight Rules
VGS	Vertically Guided Survey
VGSI	Visual Guidance Slope Indicator
VHF	Very High Frequency
VNAV	Vertical Navigation
VOR	VHF Omnidirectional Range
VORTAC	VHF Omnidirectional Range Collocated Tactical Air
VOT	VHF Omnidirectional Range Test
WAAS	Wide Area Augmentation System
WBDG	Whole Building Design Group
WCAM	Weather Camera
WEF	Wind Equipment F-400
WME	Wind Measuring Equipment
WRS	WAAS Reference System

**Page intentionally left blank.**

**Appendix 10. Index**

Accelerate-Stop Distance Available (ASDA) .....	5	Blast pad.....	3, 54, 242
Acronyms.....	295	Bridge.....	211
Acute-angled exit taxiway .....	5	Building Restriction Line (BRL) .....	4, 41
Aeronautical survey .....	17, 45, 89	Bypass taxiway .....	4, 148
Air Traffic Control Facilities (ATC-F) .....	2	Category-I (CAT-I).....	4
Aircraft.....	2	Category-II (CAT-II) .....	4
Aircraft Approach Category (AAC) .....	2	Category-III (CAT-III).....	4
Aircraft characteristics .....	219	Circling approach.....	4
Aircraft parking.....	243	Clearing requirements.....	58, 169, 258
Aircraft Rescue and Fire Fighting (ARFF).....	91	Clearway (CWY) .....	4, 76
Airplane.....	3	Cockpit over centerline steering .....	131, 219
Airplane Design Group (ADG).....	3, 14	Cockpit to Main Gear Distance (CMG).....	4
Airport.....	3	Compass calibration pad.....	4, 263
Airport data.....	15	Crossover taxiway.....	4, 149
Airport elevation .....	3	Crosswind .....	232
Airport Layout Plan (ALP) .....	3, 15	Decision Altitude (DA).....	4
Airport Reference Code (ARC) .....	3	Declared distances .....	4, 96
Airport Reference Point (ARP).....	3, 37	Definitions.....	2
Airport Surface Detection Equipment (ASDE) .....	186, 255	Deicing system.....	169, 215
Airport Surveillance Radar (ASR).....	184	Departure End of Runway (DER).....	5, 52
Airport survey .....	17, 45, 89	Departure Reference Code (DPRC)....	5, 111
Airport Traffic Control Tower (ACTC)....	36, 183	Departure surface .....	52
Airports GIS.....	17	Design aircraft.....	5, 12, 33
Aligned taxiway .....	3, 159	Displaced threshold.....	5
Approach Lighting System (ALS) ..	186, 255	Distance Measuring Equipment (DME) .	201
Approach procedure.....	87	Drainage.....	37, 160, 169, 217, 243, 260
Approach Procedure with Vertical Guidance (APV).....	3	End-Around Taxiway (EAT) .....	5, 156
Approach Reference Code (APRC)....	3, 111	End-Around Taxiway (EAT) Screen .....	159, 247
Approach surface .....	48	Engineered Materials Arresting System (EMAS).....	59, 61
Approach Surface Baseline (ASBL).....	3	Entrance taxiway.....	5, 140
Apron .....	41, 165, 257	Exit taxiway .....	5, 143, 146
Apron taxiway.....	155	Farming.....	73
Automated Surface Observing System (ASOS).....	207	Fixed-by-function Navigation Aid (NAVAID).....	5
Automated Weather Observing System (AWOS).....	207	Frangibility.....	6, 177
Beacon.....	196	Fueling .....	168, 258
Blast fence.....	3, 242	General aviation .....	6
		Geographic Information System (GIS).....	17
		Glidepath Angle (GPA) .....	6
		Glidepath Qualification Surface (GQS).....	6

Glideslope (GS) .....	6	Parallel runways.....	86
Gradient.....	77, 161, 169, 258	Parallel taxiway.....	8
Grass (turf) runway.....	82	Parapets.....	214
Hangar.....	257, 260	Parking.....	243
Hazard to air navigation.....	6	Pavement design .....	40, 160, 170, 243
Height Above Airport (HAA).....	6	Planning .....	12, 35, 87
Height Above Threshold (HATh).....	6	Precision Approach (PA) .....	8
Heliport/helipad .....	37	Precision Approach Path Indicator (PAPI) .....	196
High energy intersections .....	117	Precision Obstacle Free Zone (POFZ) .....	67
High speed exit taxiway.....	5, 143, 145, 147	Precision Runway Monitor (PRM) .....	185
Holding bay.....	152	Proposed construction.....	11
Hot spot.....	6, 121	Ramp.....	165, 257
Instrument Approach Procedure (IAP) .....	6	Related ACs, Orders, and Regulations .....	17
Instrument departure runway .....	6	Remote Transmitter/Receiver (RTR).....	184
Instrument Landing System (ILS) ..	198, 255	Rotating beacon .....	196
Intersecting runways .....	55, 80, 85	Runway .....	8
Island.....	7, 162	Runway design.....	43, 82, 92, 93, 232, 269
Jet blast.....	91, 163, 170, 241	Runway Design Code (RDC).....	8, 13
Joint-use airport .....	7	Runway End Identifier Lighting (REIL).	194
Landing Distance Available (LDA).....	5, 7	Runway end siting.....	46, 59
Large aircraft.....	7	Runway geometry .....	54
Lead-in lighting.....	193	Runway incursion .....	8, 116, 165
Lighting.....	85, 186, 215	Runway Object Free Area (ROFA) .....	69
Line of sight requirements .....	57	Runway Protection Zone (RPZ).....	9, 59, 71
Low Impact Resistant (LIR) Support.....	7	Runway Safety Area (RSA).....	9, 59, 82
Low Level Windshear Alert System (LLWAS).....	209	Runway to taxiway separation....	86, 94, 143
Main Gear Width (MGW) .....	7	Runway Visual Range (RVR).....	202
Marking and lighting....	45, 59, 85, 161, 162, 169, 178, 186, 215, 243, 260	Runway/taxiway intersections .....	140
Minimum Descent Altitude (MDA).....	7	Safety Risk Management (SRM).....	121
Modification to Standards.....	7	Security .....	39, 178, 215
Movement area.....	7	Segmented circle.....	206
Navigation Aid (NAVAID) .	5, 7, 45, 59, 61, 73, 173, 175, 255	Service road .....	73, 91, 170, 181, 215
Non-movement area.....	7	Shoulder .....	9, 54, 159, 242
Non-Precision Approach (NPA).....	7	Signs.....	162
Non-precision runway.....	7	Small aircraft.....	9
Non-Vertically Guided Survey (NVGS)...	90	Stopway.....	9, 77, 78
Object.....	7	Survey .....	17, 45, 89
Object clearing .....	58, 169, 258	TACAN.....	203
Object Free Area (OFA) .....	8, 59, 127	Takeoff Distance Available (TODA).....	5
Obstacle.....	8	Takeoff Run Available (TORA) .....	4
Obstacle Clearance Surface (OCS).....	8	Taxilane.....	9, 115, 126, 155
Obstacle Free Zone (OFZ) .....	8, 62	Taxiway.....	9
Obstruction to air navigation .....	8	Taxiway curve.....	131
		Taxiway design .....	115

Taxiway Design Group (TDG) .....	9, 14, 94, 115, 135	Turf runway .....	82
Taxiway Edge Safety Margin (TESM) .....	9	Vertically Guided Survey (VGS).....	90
Taxiway Fillet Design.....	283	Very High Frequency Omnidirectional Range (VOR) .....	203
Taxiway intersection.....	131	Visibility category.....	35
Taxiway Safety Area (TSA) .....	9	Visibility requirements.....	117, 161, 170
Taxiway turnaround.....	155	Visual runway .....	10
Taxiway width .....	122	VORTAC .....	203
Taxiway/Taxilane Object Free Area (TOFA) .....	127	Wash pad.....	258
Taxiway/Taxilane Safety Area (TSA) ....	128	Weather camera .....	207
Terminal building.....	170	Wildlife hazard.....	44
Three node concept.....	116	Wind analysis.....	231
Threshold (TH) .....	9	Wind cone .....	206
Threshold Crossing Height (TCH).....	10	Wind equipment.....	208
Tiedown .....	257	Windrose.....	235, 236
Tunnel .....	211	Wingspan .....	10

**Page intentionally left blank.**

## Record of Changes

This Record of Changes logs all Changes made to this AC since its publication. Since the changes listed below may have affected subsequent numbering within this document, the item numbering, pagination and page numbering have been adjusted accordingly.

CHG	Paragraph/Item ‡	Change
CHG 1	<u>101.e</u>	101.e – clarified limits of AC.
CHG 1	<u>102.n</u> , <u>102.dd</u> , <u>102.ee</u> , <u>102.rr</u> , <u>102.ccc</u>	102 – added definitions for Approach Reference Code (APRC), Departure Reference Code (DPRC), Departure End of Runway (DER), Height Above Airport (HAA), Minimum Descent Altitude (MDA). Revised NPA.
CHG 1		102.ppp – removed Runway Reference Code (RRC) definition.
CHG 1	<u>102.ffff</u>	Added Taxiway Edge Safety Margin (TESM).
CHG 1	<u>104.b</u>	Added “Maintenance of obstacle clearance surfaces” paragraph.
CHG 1	<u>105.b</u>	105.b – added sentence regarding exceptions requiring FAA review.
CHG 1	<u>105.c</u>	105.c – clarified wording.
CHG 1	<u>107.b(4)</u>	107.b – added “helipads” to list of airspace data.
CHG 1	<u>108</u>	108 – updated links.
CHG 1	<u>Table 1-1</u>	Table 1-1 – clarified header wording.
CHG 1	<u>Table 1-3</u>	Table 1-3 – clarified header wording; added entry for 5,000 ft RVR; added note.
CHG 1	<u>Table 2-1</u>	Table 2-1 – added “interactive” to <u>Table 3-5</u> references in this table and throughout document.
CHG 1	<u>202</u>	202 – added sentence limiting scope of AC.
CHG 1	<u>205.b(1)</u> , <u>205.b(2)</u>	205.b(1) Replaced “including” with “except” in first sentence. 205.b(2) Clarified wording of first sentence.
CHG 1	<u>303.b(1)</u> , <u>Figure 3-2</u> note, <u>303.c(1)</u>	Clarified wording for approach and departure points. Added DER clarification.
CHG 1	<u>Table 3-2</u>	Table 3-2 – changed column 1, row 7; changed footnote 3; distinguish between Categories A&B/C&D, row 3, column B, 400/800.
CHG 1	<u>Figure 3-6</u>	Synchronized with AC 150/5340-1 guidance.
CHG 1	<u>Table 3-3</u>	Table 3-3 – clarified entries and headers.
CHG 1	<u>306</u>	306 – added discussion of the heights of traverse ways.
CHG 1		310.e – paragraph deleted.
CHG 1	<u>313.b(2)</u>	313.b(2) – clarified grade change location.
CHG 1	<u>Figure 3-22</u>	Figure 3-22 – clarified grade change location.
CHG 1	<u>Figure 3-23</u>	Figure 3-23 – clarified 4:1.
CHG 1	<u>Table 3-4</u> <u>405</u>	Parallel taxiway value reverted.

‡ Paragraph/Item numbers correspond with numbering in the stated CHG version unless otherwise noted.

CHG	Paragraph/Item ‡	Change
CHG 1	<u>Table 3-4</u>	Combined Table 3-4 & Table 3-5. Updated footnotes. Subsequent tables renumbered.
CHG 1	<u>323</u> , <u>323.a</u> , <u>323.b</u>	Replaced “318. Runway Reference Code (RRC)” paragraph with APRC and DPRC. Renumbered subsequent paragraphs & tables. a. Expanded paragraph describing APRC. b. New paragraph describing DPRC.
CHG 1		319-323 – rearranged paragraph order.
CHG 1	<u>Table 3-7</u>	Replaced “Table 3-6. Minimum runway to taxiway separation / Runway Reference Code (RRC) - approach categories A and B” with new “Table 3-5. Approach Reference Code (APRC).”
CHG 1	<u>Table 3-8</u>	Replaced “Table 3-7. Minimum runway to taxiway separation / RRC - approach categories C, D, and E”.
CHG 1	<u>320.a(2)</u>	321 – added assumption and exception.
CHG 1	<u>Table 3-5</u>	Interactive Table 3-8 – clarified footnotes.
CHG 1	<u>Table 3-5</u>	Interactive Table 3-8 – updated footnote 12.
CHG 1	<u>Table 3-6</u>	Table 3-9 – updated TDG values.
CHG 1	<u>321</u>	322 – removed reference to Table 3-10 Crop Buffers. Rephrased for clarity and added reference to AC 150/5200-33.
CHG 1	<u>Figure 1-1</u>	Figure 4-1 – moved to Chapter 1 where it is first referenced.
CHG 1	<u>401.b(2)</u>	401.b(2) – added steering angle footnote.
CHG 1	<u>Figure 4-6</u>	Figure 4-7 – added TESM acronym.
CHG 1	<u>403</u>	403 – rephrased for clarity.
CHG 1	<u>404, 404.a(1)</u>	404 – rephrased for clarity.
CHG 1	<u>Table 4-1</u> notes	Table 4-1 – replaced “180 degree turns” with “direction reversal” and updated references.
CHG 1	<u>Table 4-2</u>	Table 4-2 – split TDG 1 into 1A and 1B for clarity; referenced new <u>Table 4-14. Crossover taxiways with direction reversal between taxiways based on TDG</u> ; clarified wording.
CHG 1	<u>Figure 4-8</u>	Figure 4-9 – removed note.
CHG 1	<u>Figure 4-11</u>	New <u>Figure 4-11. TSA and TOFA at taxiway intersections</u> . Renumbered subsequent figures in Chapter 4.
CHG 1	<u>405</u>	405 – expanded discussion for clarity.
CHG 1	<u>406.a</u> , <u>406.b(1), 406.b(2)</u> , <u>406.b(2)(a), 406.b(2)(b)</u>	406 – rephrased for clarity. (1) Rephrased for clarity; added discussion of crossover taxiways. (2) New paragraph discussing modeling of airplane movements. (2)(a) Rephrased for clarity and updated. (2)(b) Added reference to online DXF files.
CHG 1	<u>Table 4-3</u>	Table 4-3 – split TDG 1 into 1A and 1B for clarity, showing only 1A in this table now.
CHG 1	<u>Table 4-4</u>	New table for TDG 1B.
CHG 1	<u>Table 4-5</u>	Table 4-4 – updated. Removed 180 degree column & W-3 row.
CHG 1	<u>Table 4-6</u>	Table 4-5 – revised table to include TDG 3 only, removing TDG 4. Removed 180 degree column. Removed W-3 row.



CHG	Paragraph/Item ‡	Change
CHG 1	<u>Table 4-7</u>	Table 4-5 – Added new table for TDG 4. Removed 180 degree column. Removed W-3 row.
CHG 1	<u>Table 4-8</u>	Table 4-6 – Updated TDG 5 table. Removed 180 degree column. Removed W-3 row.
CHG 1	<u>Table 4-9</u>	Table 4-7 – Updated TDG 6 table. Removed 180 degree column. Removed W-3 row.
CHG 1	<u>Table 4-10</u>	Table 4-8 – Updated TDG 7 table. Removed 180 degree column. Removed W-3 row.
CHG 1	<u>Table 4-11</u>	New MGW-CMG combinations table.
CHG 1	<u>Figure 4-16</u>	New MGW-CMG combinations figure.
CHG 1	<u>411</u>	407 – expanded; added direction reversal discussion. Subparagraphs include distinctions between situations w/ or w/o reversal.
CHG 1		407-411 – rearranged paragraph order.
CHG 1	<u>411.a</u> , <u>411.a(1)</u> , <u>411.a(2)</u>	407 – new subparagraph heading. Subparagraphs expanded to include distinctions between new and existing construction. (1) Expanded to include common ADG/TDG combinations. (2) New paragraph.
CHG 1	<u>411.b</u>	407 – new subparagraph containing rephrased discussion of crossover taxiways without direction reversal, and referencing new Figure 4-25.
CHG 1	<u>Table 4-14</u>	New table for crossover taxiways with direction reversal between taxiways based on TDG.
CHG 1	<u>Figure 4-25</u>	New figure for crossover taxiways with direction reversal between taxiways
CHG 1	<u>Figure 4-23</u>	New figure depicting a crossover taxiway where direction reversal is needed based on TDG.
CHG 1	<u>Table 4-15</u>	New table for Crossover Taxiways with direction reversal between taxiways based on ADG.
CHG 1	<u>Figure 4-24</u>	Figure 4-16 – expanded title.
CHG 1	<u>408.a</u>	410 – expanded discussion on direction reversal.
CHG 1	<u>Figure 4-17</u>	New figure depicting an entrance taxiway.
CHG 1	<u>Table 4-12</u>	New table for runway entrance taxiway dimensions.
CHG 1	<u>408.b</u>	410 – clarified wording.
CHG 1	<u>409.b</u>	411 – removed exception in next-to-last sentence.
CHG 1	<u>409.c</u> , <u>409.d(1)</u> , <u>409.d(2)</u>	411 – rephrased for clarity. (2) Added sentence referencing online DXF availability.
CHG 1	<u>Figure 4-18</u>	Figures 4-20:4-25 – Replaced foldouts with a single generic representative figure.
CHG 1	<u>416</u>	416 – in second sentence, replaced “relocated threshold” with “new threshold.”
CHG 1	<u>Figure 4-31</u>	Figure 4-31 – changed ADG-IV references to ADG-III.
CHG 1	<u>Figure 4-33</u>	Figure 4-33 – clarified 4:1.
CHG 1	<u>Figure 4-32</u>	Figure 4-34 – expanded labels.

<b>CHG</b>	<b>Paragraph/Item ‡</b>	<b>Change</b>
CHG 1	<u>504.e(2) &amp; 504.f(1)</u>	504e(2) & 504f(1) minor edits.
CHG 1	<u>621.a(1)</u>	Metric conversion correction.
CHG 1	<u>A1-3</u>	A1-3 – added statement regarding aircraft characteristics data available subsequent to this release.
CHG 1	<u>Table A1-1</u>	Table A1-1 – updated.
CHG 1	<u>Table A1-1</u>	Updated Boeing CMG and TDG values.
CHG 1	<u>Table A1-1</u>	Expanded Bombardier listings.
CHG 1	<u>Table A7-1 thru Table A7-12</u>	Tables A7-1:A7-11 – footnotes updated. Table references to footnotes updated.
CHG 1	<u>Table A7-1 thru Table A7-12</u>	Updated footnote 12.
CHG 1	<u>Table A7-2</u>	Table A7-2 – updated table.
CHG 1	<u>Table A7-3</u>	Added table for A/B – II Small aircraft.
CHG 1	<u>Appendix 8</u>	New Taxiway Fillet Design appendix.
CHG 1	<u>Appendix 9 Acronyms</u>	Appendix 8 – added new acronyms APRC, DPRC, HAA, MDA, NVGS, TESM, VGS; removed RRC.
CHG 1	<u>Appendix 10 Index</u>	Appendix 9 – added APRC, DPRC, HAA, MDA, NVGS, TESM, VGS, and Taxiway Fillet Design.