

STATE OF NEVADA
DEPARTMENT OF TRANSPORTATION
CONSTRUCTION DIVISION

SYNOPSIS OF

**MATERIALS
DIVISION
TESTING MANUAL**

**FOR
FIELD TESTING**

CARSON CITY, NEVADA
November 1, 2016

TABLE OF CONTENTS
NUMERICAL SEQUENCE
FIELD TESTS

Nev. Test No.	
T102H	Method of Test for In-Place Density of Treated and Untreated Soils and Aggregates
T103G	Method of Test for Density and Moisture Content of Soils and Aggregates by the use of Nuclear Gauges
T104D	Method of Test for Apparent Specific Gravity of Coarse Aggregates
T108B	Method of Test for the Determination of Maximum Density and Optimum Moisture Content of Soils using the Modified Proctor Device
T111D	Method of Test for Specific Gravity and Absorption of Coarse Aggregates
T112F	Method of Test for Moisture Content in Soils and Aggregates
T200E	Standard Methods of Sampling Stone, Gravel, Sand and Paving Mixtures for Use as Highway Materials
T203G	Method of Test for Reducing a Representative Test Sample of Soil and Aggregate
T206G	Method of Test for Washing and Sieve Analysis of Coarse and Fine Aggregate
T210J	Method of Test for Determining the Liquid Limit of Soil
T211J/T212J	Method of Test for Determining the Plastic Limit and Plasticity Index of Soil
T227I	Method of Test for Sand Equivalent
T228C	Method of Test for Evaluating Cleanness of Coarse Aggregate.
T230D	Method of Test for Determining the Percent of Fractured Faces
T237A	Method for Determination of Compressive Strength of Cement Treated Base and Cement Treated Subgrade (Field Method)
T239B	Method of Determination of the Cement Content of Cement Treated Base and Cement Treated Subgrade
T306D	Method of Test for Determining Moisture Content of Bituminous Mixtures Using Microwave Ovens

TABLE OF CONTENTS
NUMERICAL SEQUENCE
FIELD TESTS

Nev. Test No.	
T325A	Method of Test for the Determination of Theoretical Maximum Specific Gravity of Uncompacted Bituminous Paving Mixtures (Field Method)
T335G	Method of Test for Relative Compaction of Plantmix Bituminous Base and Surface Using a Nuclear Density Gauge
T336C	Method of Test for Bulk Specific Gravity and Density of Compacted Bituminous Mixtures (Field Method)
T416B	Method of Test for Sampling, Determining Unit Weight, Air Content, and Making and Curing Specimens of Hydraulic-Cement Self-Consolidating Concrete
T417B	Method of Test for Unobstructed Slump Flow and Stability of Hydraulic-Cement Self-Consolidating Concrete
T418C	Method of Test for Passing Ability of Hydraulic-Cement Self-Consolidating Concrete by J-Ring and Slump Cone
T425E	Standard Method of Test for Sampling Fresh Concrete
T426C	Method of Test for Flow of Grout Mixtures (Flow Cone Method)
T427B	Standard Method of Test for Making and Curing Grout or Mortar Compression Test Specimens in the Field
T428F	Standard Method of Test for Making and Curing Concrete Compression Test Specimens in the Field
T431D	Method of Test for Air Content of Freshly Mixed Concrete by the Volumetric Method (Roll-A-Meter)
T432E	Method of Test for Air Content of Freshly Mixed Concrete by the Pressure Method
T435F	Method of Test for Density (Unit Weight) and Volume of Concrete
T438C	Method of Test for Slump of Portland Cement Concrete (Cone Method)
T439C	Method of Test for Ball Penetration in Fresh Portland Cement Concrete
T440D	Method of Test for Measuring Surface Temperature of In Place Portland Cement Concrete

TABLE OF CONTENTS
NUMERICAL SEQUENCE
FIELD TESTS

Nev. Test No.	
T441A	Method of Test for Measuring Temperature of Fresh Concrete
T442G	Method of Test for Making and Curing Concrete Beam Specimens in the Field and for Determining Flexural Strength of Concrete Using Simple Beam with Third-Point Loading
T446E	Method of Test for Evaluation of Pavement Profiles – English
T448A	Method of Test for Evaluation of Pavement Ride Quality using Inertial Profiling Systems
T492C	Method of Test for Bulk Specific Gravity (S.S.D.) and Absorption of Coarse Aggregate for Concrete
T493E	Method of Test for Bulk Specific Gravity and Absorption of Fine Aggregate
T510A	Method for Determination of Dry Film Thickness of Epoxy or Waterborne Pavement Marking Materials
T511A	Method of Test for Determining Retroreflective Properties for Pavement Striping
T512A	Method of Test for Pavement Marking Film Adhesion
T723F	Sampling Bituminous Materials
T750D	Method of Test for Relative Compaction of Plantmix Bituminous Surface and Cold In Place Recycle Using Control Strips and Test Sections with a Nuclear Density Gauge
T759H	Method of Test for Emulsified Asphalt
T761H	Method of Test for Determining Bitumen Ratio in Hot Mix Asphalt by the Ignition Method
ASTM D4263	Standard Test Method for Indicating Moisture in Concrete by the Plastic Sheet Method (Designation: ASTM D 4263-83 (Reapproved 2012))
ACI 503R	Polymer Concrete, Test for Surface Soundness and Adhesion (Appendix A of the ACI Manual of Concrete Practice)

State of Nevada
Department of Transportation
Materials Division

**METHOD OF TEST FOR IN-PLACE DENSITY OF TREATED AND
UNTREATED SOILS AND AGGREGATES**

SCOPE

This test method is used to determine in-place density of treated and untreated soils, aggregate bases, sub-bases, cement or lime treated bases and selected materials. In-place density is the density of a soil as it exists in its natural state or compacted condition. As used herein, the term soil includes all material types and all particle sizes present in the material to be tested.

Density is defined as the unit weight of the soil or aggregate, usually expressed in terms of Mg/m^3 (lb/ft^3). If oven-dry condition does not prevail, the unit weight is termed wet density. If the soil or aggregate is in an oven-dry condition, the unit weight is termed dry density. Oven-dry condition is the condition of soil after it has been dried to a constant weight at a temperature of $110 \pm 5^\circ\text{C}$ ($230 \pm 9^\circ\text{F}$).

This test method requires excavating and weighing a sample of soil, measuring the volume of the sample, and calculating its density. If dry density is desired, this procedure also details the determination of the moisture content of an excavated sample, and converting from wet density to dry density.

The use of the maximum density and relative compaction of soils shall be determined in accordance with Test Method Nev. T108. This method shall be used to obtain the maximum density value for volume-to-weight conversion factors.

APPARATUS

1. Sand cone volume apparatus, Figure 1 - three piece sand cone with 200 mm (8 in.) measuring vessel (hat); or Figure 2 - one piece sand cone with 250 mm (10 in.) measuring vessel (hat).
2. Scale, hanging balance or platform type, 31 kg (70 lb) minimum capacity, graduated to 0.05 kg (0.1 lb) or finer.
3. Oven, capable of maintaining a temperature of $110 \pm 5^\circ\text{C}$ ($230 \pm 9^\circ\text{F}$).
4. Electric hot plate or gas stove.

5. Sand, 20 mesh, consisting of clean, dry, free-flowing particles that will not degrade under repeated use. Beach sand containing organic materials, deliquescent salts or sand having any hygroscopic properties is not acceptable.

If the sand is coarser than the material being excavated, 50 mesh sand may be utilized. Should the use of 50 mesh sand occur, a dust mask shall be used and documented by the Resident Engineer accepting its use.

6. Drum, metal 208 L (55 gal.) with pour spout for sand.
7. Sample containers, any suitable container with a lid that will prevent loss of moisture during transport.
8. Drying pans, scoops, brushes, etc.
9. Digging bar, maximum length of 914 mm (36 in.) and maximum diameter of 25 mm (1 in.).
10. Sample splitter or quartering canvas.

CALIBRATION OF STANDARD TEST SAND

Step 1: Calibration of cone and measuring vessel (hat)

Use a 200 mm \pm 12.7 mm (8 in. \pm 0.5 in.) measuring vessel (hat) with the three piece sand cone and a 250 mm \pm 12.7 mm (10 in. \pm 0.5 in.) measuring vessel (hat) with the one piece sand cone. Determine the volume of the measuring cone and volume of the measuring vessel (hat) before calibrating the sand. The calibration of the test sand determines the weight per unit volume of sand when poured into a container under controlled conditions. Calibration of the sand shall be performed in a vibration free location. The function of the sand cones shown in Figures 1 and 2 are to assure that the sand will be poured under identical conditions in each instance. For this calibration procedure, sand is poured into a measuring vessel (hat) rather than into a test-hole.

1. If using the three piece sand cone (Figure 1), it is noted that variations in the volume of the measuring cone differ, therefore the unit shall be calibrated annually. Calibration is performed using water and a glass plate to eliminate entrapped air. The following procedure shall be used: Level the scale; place the overflow vessel on the scale; cover the neck of the cone to avoid losing any water (duct tape, etc.) and place in the overflow vessel (make sure the cone is level in the overflow vessel); place the glass plate over the cone and zero the scale; remove the glass plate and carefully fill the cone with water at $25 \pm 3^{\circ}\text{C}$ ($77 \pm 5^{\circ}\text{F}$); place the glass plate over the opening to ensure there is not any entrapped air under the glass plate. Refer to number 3. of this section for the calculations.

Use the 200 mm ± 12.7 mm (8 in. ± 0.5 in.) measuring vessel (hat) with the three piece sand cone. Determine the volume of the 200 mm ± 12.7 mm (8 in. ± 0.5 in.) measuring vessel (hat) using water and a glass plate. The following procedure shall be used: Level the scale; place the measuring vessel (hat) on the scale with the glass plate over the measuring vessel (hat) and zero the scale; remove the glass plate and carefully fill the measuring vessel (hat) with water at 25 ± 3°C (77 ± 5°F); place the glass plate over the opening to ensure there is not any entrapped air under the glass plate. Refer to number 3. of this section for the calculations.

2. If using the one piece sand cone (Figure 2), it is noted that variations in the volume of the cone differ, therefore the unit shall be calibrated annually. Calibration is performed using water and a glass plate to eliminate entrapped air. The following procedure shall be used: Level the scale; turn the one piece sand cone upside down on the scale; close the sand valve and make sure it is water tight using petroleum jelly (Vaseline, etc); place the glass plate over the cone and zero the scale; remove the glass plate and carefully fill the measuring cone with water at 25 ± 3°C (77 ± 5°F); place the glass plate over the opening to ensure there is not any entrapped air under the glass plate. Refer to number 3. of this section for the calculations.

Use the 250 mm ± 12.7 mm (10 in. ± 0.5 in.) measuring vessel (hat) with the one piece sand cone. Determine the volume of the measuring vessel (hat) using water and a glass plate. The following procedure shall be used: Level the scale; place the measuring vessel (hat) on the scale with the glass plate over the measuring vessel (hat) and zero the scale; remove the glass plate and carefully fill the measuring vessel (hat) with water at 25 ± 3°C (77 ± 5°F); place the glass plate over the opening to ensure there is not any air trapped under the glass plate. Refer to number 3. of this section for the calculations.

3. Record the weight of water required to fill the cone or the measuring vessel (hat) to the nearest 0.1 lb and designate as "W". Use the following formula to calculate the volume of the cone and the volume of the measuring vessel (hat):

Volume = W/62.4 (English units must be used):

V = Volume in cubic feet

W = Weight of water used to fill the cone or the measuring vessel (hat) in pounds

62.4 = Weight of one cubic foot of water

If the volume is required in cubic meters, multiply the volume in cubic feet by 0.0283168 (rounded to the nearest 0.001)

Do not write the volume on the equipment. Record results on NDOT form 040-067.

Step II: Sand Calibration

1. Determine the sand density by filling the sand cone and measuring vessel (hat) with three trial pours of sand, weigh and record to the nearest 0.1 lb. Average the three trial pours and divide by the volume of the cone and measuring vessel (hat), this equals the sand density in lb/ft³. To obtain Mg/m³, divide the lb/ft³ by 62.4. (rounded to the nearest 0.001)
2. The three trial pours shall be within ± 0.2 lb of each other. If the three trial pours are not within 0.2 lb of each other, repeat this procedure.

Calibrate each shipment of sand prior to the start of each project, before using it in any test-hole measurements, and each time new sand is added to the barrel (thoroughly mix old sand with new sand). Do not blend sand supplied by different manufacturers.

Record results on NDOT form 040-068.

EXCAVATION OF TEST SAMPLE

1. Location of the test site should be such that the soil and degree of compaction encountered will be representative of the average conditions in the area. If large rocks are encountered, it may be necessary to move to a new test site. If organic material (leaves, sticks, etc.) is encountered, it must be removed from the test sample after total wet weight has been obtained.
2. Prior to starting excavation, clear away all loose surface material and level off a test site area at least 0.2 m² (2 ft²). For areas compacted by pneumatic tired or steel wheeled rollers, remove disturbed surface material. Where a sheeps foot or tamping roller are used, remove loose surface material to a depth of not less than 50 mm (2 in.) below the deepest disturbance by the roller after completion of compaction. When testing on a slope, level the testing area as much as possible without building a pad (the cone shall not be tilted, this may result in erroneous density values). The edge of the leveling plate may be used as a scraper to level the surface.
3. Place the leveling plate on the prepared test area and secure the leveling plate to the surface by driving the corner pins into the soil. Using the circular template as a guide and without disturbing the surrounding material, dig a neat, clean-cut hole 250 to 300 mm (10 to 12 in.) in diameter and a depth of 75 to 200 mm (3 to 8 in.).¹ To maintain the necessary degree of accuracy in weighing and measuring operations, test sample excavation shall not be less than 0.0042 m³ (0.150 ft³). Scoops or digging bars may be used to excavate the test-hole. When digging bars are used, do not pry back against the wall of the hole in any manner that will compress the area. Regardless of the method of excavation, trim the sides and bottom of the hole as smooth as possible. A small, soft brush shall be used to sweep the sides and bottom of the hole to remove all loose material.

¹ Size of the plate used will depend on the thickness of the soil layer to be tested to obtain the required volume of material. In minimum thickness layers, a 250 mm \pm 12.7 mm (10 in. \pm 0.5 in.) leveling plate shall be used. When the soil layer is 75 mm (3 in.) or less, a 300 mm \pm 12.7 mm (12 in. \pm 0.5 in.) leveling plate shall be used.

4. Exercise care to prevent loss of any excavated sample or its moisture prior to weighing. Use a tightly covered container to reduce loss of moisture. Weigh and record to the nearest 0.01 kg (0.1 lb).

Where different types of material are deposited in layers, do not penetrate different layers with a single test-hole or combine excavated material into a single sample. Each of these soil types might be compacted to specification requirements based on their individual maximum densities, but test maximum density of the combination may be entirely different, and result in an erroneous test result.

SAND VOLUME MEASUREMENT OF THE TEST-HOLES

1. Obtain at least 23 kg (50 lb) of sand in a suitable pouring container and record to the nearest 0.01 kg (0.1 lb).
2. If using the three piece sand cone, center the three piece sand cone over the leveling plate and test-hole. Pour the calibrated sand into the regulating funnel rapidly enough to maintain a sand level in the funnel at about 19 mm (3/4 in.) below the top edge. Pour until the hole and cone are filled, as indicated by sand overflowing into the overflow vessel. Tests have shown that a steady sand flow while pouring is essential and that an inconsistent flow of sand through the orifice may result in a considerable error. Do not stop the flow of sand once the pouring has begun. Stop the sand pour immediately upon overflow and allow the balance of sand remaining in the regulating funnel to completely empty into overflow vessel. Hold the large measuring cone so it cannot move and rotate the overflow vessel a few turns to free it from the neck of the measuring cone prior to its removal. Remove the regulating funnel and lift the overflow vessel off the measuring cone. Sand that has overflowed into the overflow vessel is not incorporated into the test-hole measurement and is returned to the original sand supply remaining in the pouring container. Weigh and record sand in the pouring container as (weight of residue) to the nearest 0.01 kg (0.1 lb). The difference between initial weight of sand in the pouring container and weight of residue remaining after pouring the sand, represents the weight of sand used to fill the volume of the hole, cone and leveling plate. Use the same sand cone during testing that was used to calibrate the sand.
3. If using the one piece sand cone, center the one piece sand cone over the test-hole and leveling plate. Close the sand valve and pour the weighed sand into the upper portion of the one piece sand cone and cover the opening with a lid. Open the sand valve and let the sand flow into the excavated hole and measuring cone until the sand stops moving. Immediately close the sand valve and place the one piece sand cone on top of the pouring container. Open the sand valve and allow the remaining sand to flow into the container. Weigh and record sand in the pouring container as weight of residue to the nearest 0.01 kg (0.1 lb). The difference between the initial weight of sand in the pouring container and weight of residue remaining after pouring the sand, represents the weight of sand used to fill the volume of the hole, cone and leveling plate. Use the same sand cone during testing that was used to calibrate the sand.

During the pouring of sand, the apparatus must not vibrate or be touched. Stop any equipment causing ground vibration during the pouring process.

If the sand contained in the measuring cone does not become contaminated with the soil in the excavated area, it may be salvaged for reuse. Recover sand from measuring cone by placing the edge of large recovering scoop slightly under the edge of cone, then slide cone onto the scoop and place in an empty pouring container.

The sand in the test-hole may have picked up moisture or foreign matter, therefore salvage may not be possible.

CALCULATION OF TEST-HOLE VOLUME

Knowing both the weight per unit volume of the sand (sand density) when it is poured into the test-hole by the sand cone procedure, and weight of sand used to fill the test-hole, measuring cone and leveling plate (weight of sand used), the test-hole volume in m^3 (ft^3) may be computed from the following formula:

Report all volumes to the nearest 0.001

$$\text{Volume of Test-Hole} = \left(\frac{\text{weight of sand used}}{\text{sand density}} \right) - (\text{volume of cone} + \text{leveling plate})$$

Volume of the cone and plate in m^3 (ft^3) may be computed using the following formula:

$$\text{Volume of Cone} = m^3 = W/62.4 (0.0283168) \quad \text{or} \quad ft^3 = W/62.4$$

$$\text{Volume of Leveling Plate} = m^3 = \frac{\pi r^2 h}{1,000,000,000} \quad \text{or} \quad ft^3 = \frac{\pi r^2 h}{1728}$$

Where $\pi = 3.1416$

r = radius of circular cut-out of plate, mm (in.)

h = thickness of leveling plate, mm (in.)

W = weight of room temperature water $25 \pm 3^\circ C$ ($77 \pm 5^\circ F$) to fill up the measuring cone

IN-PLACE WET DENSITY

Determine the in-place wet density from the following formula:

Report to the nearest 0.1

$$\text{In-place Wet Density} = \left(\frac{\text{wet weight of total excavated sample}}{\text{volume of hole}} \right)$$

MOISTURE DETERMINATION

Where it is desired to ascertain the density of soil in terms of oven-dry weight, it is necessary to perform a moisture determination using a representative portion in accordance with Test Method Nev. T200. Moisture sample must be of sufficient size to represent the total excavated sample with consideration given to the amount and nature of the coarse aggregate fraction. Accurately weigh the amount to be used for moisture determination, then thoroughly dry in accordance with Test Method Nev. T112. Re-weigh after drying and calculate the moisture content from the following formula:

Report to the nearest 0.1

$$\text{Percent Moisture} = \left(\frac{\text{weight of wet soil} - \text{weight of dry soil}}{\text{weight of dry soil}} \right) \times 100$$

This moisture content is known as in-place moisture content because it denotes the moisture condition of in-place soil and will be used to determine the in-place dry density. As the materials maximum dry density is determined per Test Method Nev. T108, additional screening to determine retained fractions of + 4.75 mm (+ No. 4) and or + 19.0 mm (+ 3/4") of the excavated material is unnecessary.

CONVERSION OF WET DENSITY TO DRY DENSITY

Convert wet density to dry density from the following formula:

Report to the nearest 0.1

$$\text{In-place Dry Density} = \left(\frac{\text{in-place wet density}}{\text{in-place \% moisture content} + 100} \right) \times 100$$

REPORT

Report compaction to the nearest whole percent.

NOTES

1. Test Method Nev. T104 and T108 must be performed whenever the material changes, a second re-test is required or test results exceed 102 percent compaction. These two test methods shall be performed concurrently.
2. When drying gypsum or material blended with recycled asphalt pavement, dry in accordance with Test Method Nev. T112, Method A, using a temperature of 60°C (140°F), to avoid changing the nature of the sample.

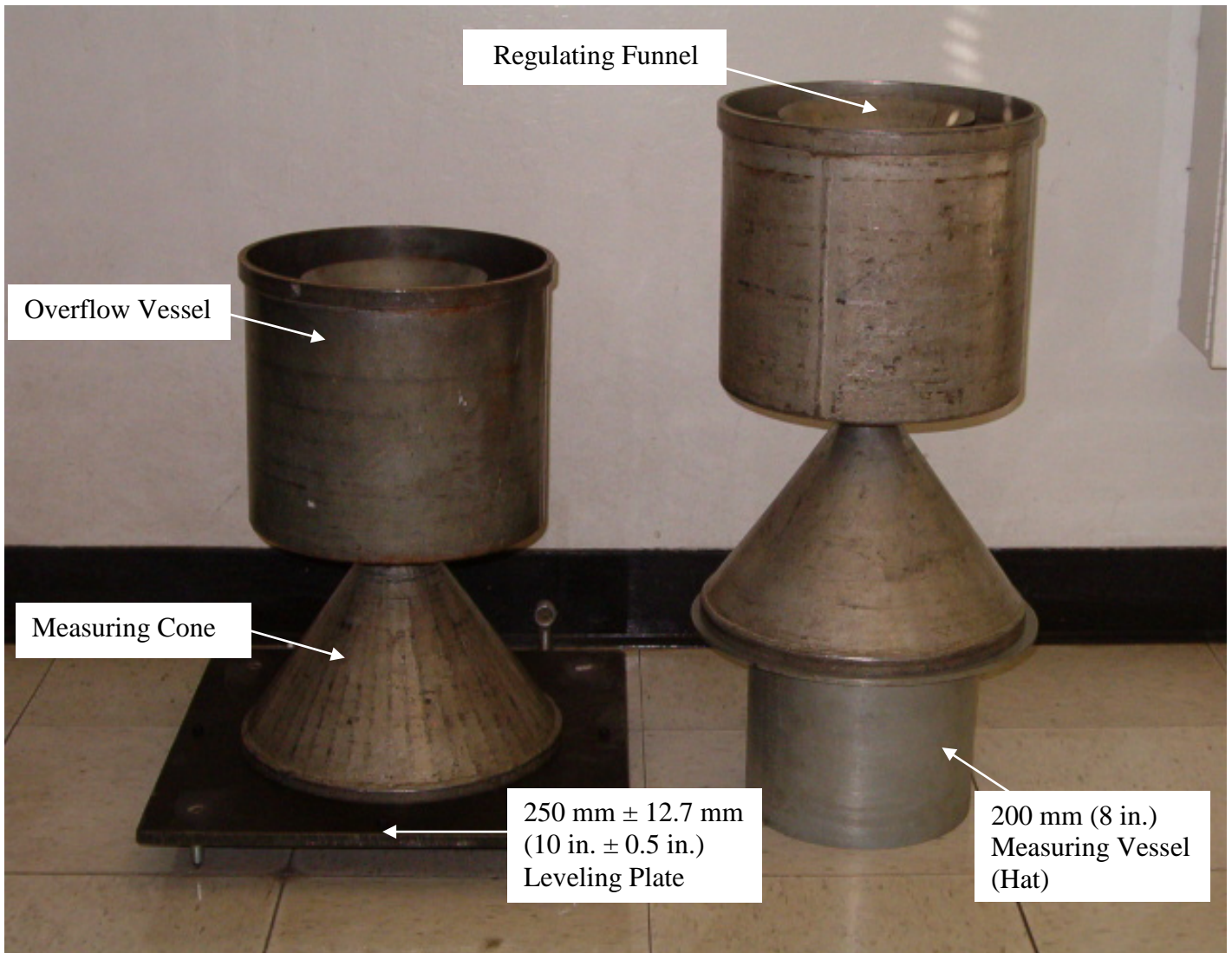

Three piece sand cone and 200 mm (8 in.) measuring vessel (hat)

FIGURE 1

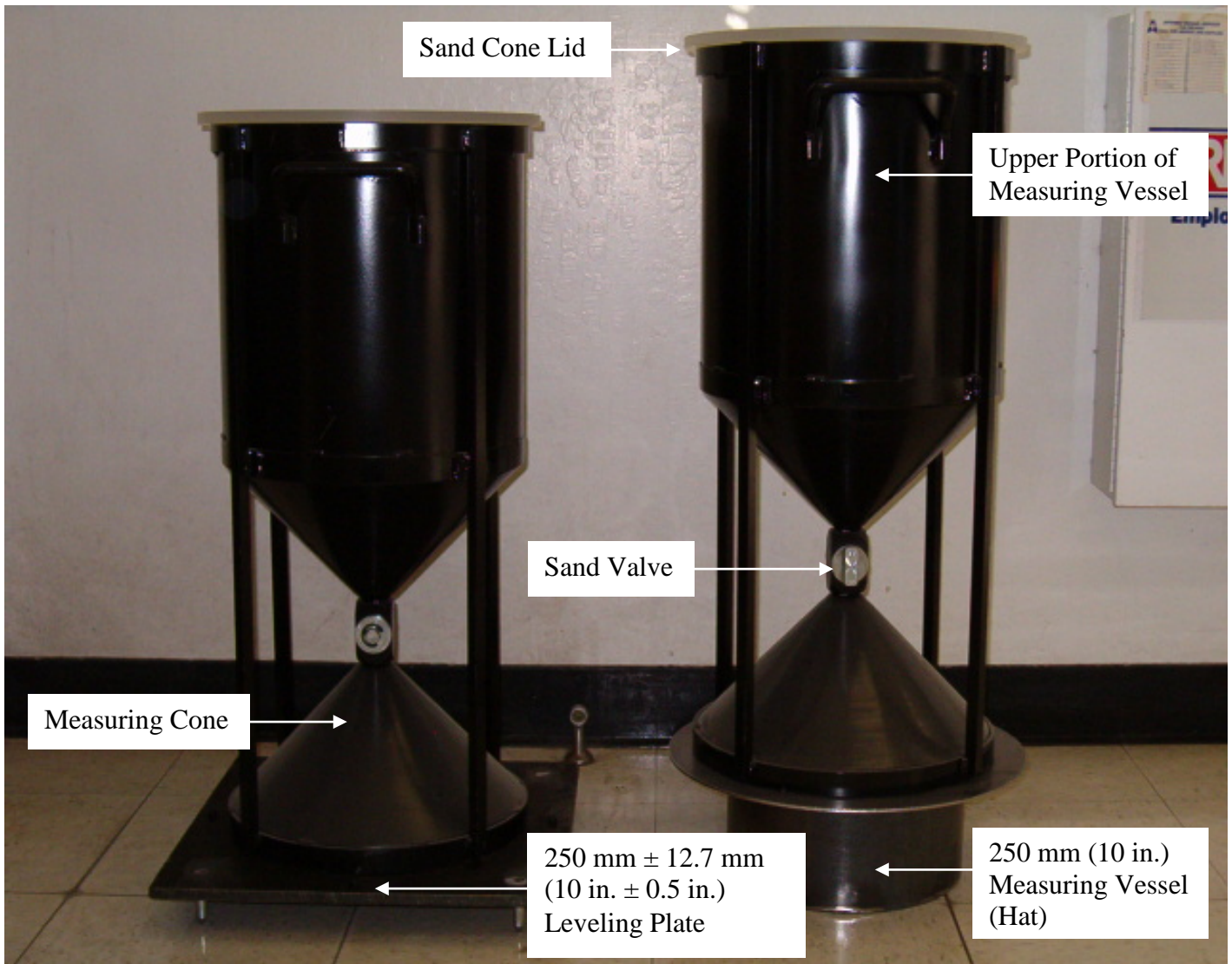

One piece sand cone and 250 mm (10 in.) measuring vessel (hat)

FIGURE 2

State of Nevada
Department of Transportation
Materials Division

**METHOD OF TEST FOR DENSITY AND MOISTURE CONTENT OF
SOILS AND AGGREGATES BY THE USE OF NUCLEAR DENSITY GAUGES**

SCOPE

This test method is used to determine in-place density and moisture content of soils and aggregates by the use of nuclear equipment. The wet density in kg/m^3 (lb/ft^3) is determined using the "Direct Transmission Mode". The rod containing the Cesium-137 (Cs-137) source is lowered to the desired depth, resulting in Gamma radiation emission. It is a rapid, non-destructive technique, designed for control and acceptance testing of compaction of soils and aggregates for highway construction.

This method described for density is suitable to a test depth from 50 to 200 mm (2 to 8 in.). The moisture test is generally suitable to a depth of up to 175 mm (7 in.). However, it is heavily dependent on the moisture content, with very high moisture contents reducing the effective depth to about 100 mm (4 in.). Test results may be affected by the chemical composition, sample heterogeneity and surface texture of the material.

Nuclear density gauges utilize radioactive materials, which, that even though present in small quantities, must be handled with care to avoid health hazards to the operator and other individuals surrounding the moisture-density gauge.

APPARATUS

1. Moisture-Density Gauge, Troxler Model 3440 or 3450, consisting of the following major components:
 - a. Gamma Source, housed in the probe, shall be an encapsulated and sealed radio isotopic source such as Cesium-137 (Cs-137).
 - b. Probe, containing the gamma source, designed for inserting into a preformed hole in the soil. It shall be marked in increments to indicate the depth it is to be placed in the soil. It shall be constructed so that when moved to a desired depth, it will be held securely in position at that depth and have an automatic depth indicator with a back up manual depth indicator.
 - c. Gamma Detector, such as a Geiger-Mueller tube or tubes.
 - d. Fast Neutron Source, a sealed isotope material such as Americium 241:Beryllium (AM 241:Be). It shall be contained in a separate sealed capsule.

- e. Slow neutron detector, such as helium three tubes (He-3 tubes).
 - f. Readout Device, any suitable type which usually includes a high and low voltage power supply necessary to operate the detectors, readout, and accessory devices. Commonly referred to as the scaler.
 - g. Housing, shall be moisture and dust proof and of rugged construction to protect the sources, detectors, readout device and power supplies which are contained therein.
 - h. Offsets, capable of performing density, moisture and trench adjustments through offset functions.
2. Drill Rod, a steel pin having a nominal diameter slightly greater than the probe, but not to exceed the diameter of the probe by more than 3 mm (1/8 in.). Used to form a hole in the soil to be tested.
 3. Guide and Site Preparation Device, one piece of equipment, a steel or aluminum plate leveling tool used to plane the test site to the required smoothness and for aligning the hole perpendicular to the prepared surface for the probe.
 4. Reference Standard Block, provided with each moisture-density gauge for checking equipment operation and to provide a stable condition for a reproducible count rate.

STANDARDIZATION

1. Warm up period: Turn the moisture-density gauge on and warm up for ten minutes. This allows the regulators and deflectors to stabilize.
2. At the start of each shift, standardize the moisture-density gauge to check equipment operation. This procedure can also be used as an operational check whenever test measurements are suspect or when poor correlation is encountered during the correlation check.
3. The site chosen for standardization should remain the same throughout the contract. Outline the standard block with keil (lumber crayon) to ensure the same location is used.
4. Place the standard block on a solid surface having a density of 1600 kg/m^3 (100 lb/ft^3) or greater, preferably a plantmix or concrete surface. Ensure that the standard block is level and does not rock back and forth. This location should be at least 3 m (10 ft) from any large object such as a vehicle, field lab, wall, or any water source and at least 9 m (30 ft) from another nuclear gauge.
5. Place the moisture-density gauge on the standard block and properly seat within the recessed area of the standard block. Place the scaler end against the metal plate on the standard block and check to make sure the moisture-density gauge does not rock on the standard block.

6. With the lock attached and the handle in the "safe" position, press the "STANDARD" key on the keypad. The screen will show "Standard Count DS=XXX MS=XXX Take a new count"? Press the "YES" key. The screen will then show "Is gauge on standard block and source rod in safe position"? Check to make sure, then press the "YES" key. The moisture-density gauge will begin taking a four-minute standard count.
7. When counting stops, at the end of the four minutes, screen will say "MS = XXX XX.XX % P, DS = XXX XX.XX % P, Do you want to use new standards"? If it shows a PASS/PASS, record the density standard count (DS) and moisture standard count (MS) in the gauge log book and on the appropriate form, then press the "YES" key. If you receive a PASS/PASS to the right of the percentages, it indicates that the standard counts are within the 1% density tolerance and 2% moisture tolerance.
8. If the density standard (DS) or moisture standard (MS) count fails, the screen will show "Do you want to use the new STD"? Press the "YES" key. Check the moisture-density gauge seating and positioning, is the standard block on a flat and recommended surface? If yes, then take another standard count.
9. It may take up to five standard counts before obtaining a PASS/PASS result. In the event that a PASS/PASS result is not obtainable, contact the Independent Assurance Lab for further assistance.

DENSITY CORRELATION (3440 or 3450 SERIES GAUGES)

1. During correlation, the offsets must be off.
2. Perform correlation tests at three locations. Correlation tests may be performed on the jobsite or an informational pad using approved representative material that will be incorporated into the project. Take the moisture-density gauge tests first. Refer to Figure 1 for correct positioning of the moisture-density gauge during correlation testing. For the correlation procedure, be sure to perform all of the nuclear density tests and the sand cone tests at the same depth to allow all tests to be compared as a group. Once correlated, the moisture-density gauge may be used at any rod depth.
3. After the three correlation holes are completed in accordance with Test Method Nev. T102 and this test method, average the three sand cone wet densities and average the three moisture-density gauge wet densities. Subtract the moisture-density gauge wet density average from the sand cone wet density average, this equals the moisture-density gauge offset for the wet density. See Table 1 for an example.
4. Enter the density offset, calculated above in kg/m^3 (lb/ft^3) with the proper sign (\pm) into the moisture-density gauge. Follow the flow chart in the moisture-density gauge manual under wet density offsets.
5. Check the density offset every shift and every time a different material is used to ensure that the number entered into the moisture-density gauge is still the correct value for the material being tested. If the moisture-density gauge turns off, all offsets may default to the off position.

MOISTURE CORRELATION (3440 or 3450 SERIES GAUGES)

1. During correlation, the offsets must be off.
2. Perform correlation tests at three locations. Correlation tests may be performed on the jobsite or an informational pad using approved representative material that will be incorporated into the project. Take moisture-density gauge tests first. Refer to Figure 1 for correct positioning of the moisture-density gauge during correlation testing. For the correlation procedure, be sure to perform all of the moisture-density gauge tests and the sand cone tests at the same depth to allow all tests to be compared as a group. Once correlated, the moisture-density gauge may be used at any rod depth.
3. After the three correlation holes have been completed in accordance with Test Method Nev. T102 and this test method, average the three sand cone moistures and average the three moisture-density gauge moistures. See Table 1 for an example.
4. Determine the moisture content of the samples obtained from the moisture-density gauge/sand cone correlation tests per Test Method Nev. T112. Record these results on the appropriate form. See Table 1 for an example.
5. Use the formula in Table 1 to calculate the moisture correction factor.
6. Follow the flow chart in the moisture-density gauge manual under "Moisture Offsets". Select "Gauge Derived" for source of offset. The moisture-density gauge will derive the moisture offset.
7. Once derived, follow the flow chart in the moisture-density gauge manual under "Moisture Offset - Gauge Derived".
8. Check the moisture offsets every shift and every time a different material is used to ensure that the number entered in the gauge is still the correct value for the material being tested. If the moisture-density gauge turns off, all offsets may default to the off position.

Table 1
In-Place Wet Density Correlation
With Offsets Disabled

<u>Test No.</u>	<u>Sand Cone Wet Density</u>	<u>Nuclear Gauge Wet Density</u>	
1-1B-95	2.239 (139.7)	2.228 (139.0)	
2-1B-95	2.210 (137.9)	2.189 (136.6)	
3-1B-95	2.212 (138.0)	2.228 (139.0)	
Average	2.220 (138.5)	2.215 (138.2)	<u>Difference (±)</u> + 0.005 (+ 0.3)
	Avg. Sand Cone - Avg. Nuclear Gauge = Nuclear Gauge Offset (carry to .001 (0.1))		
<u>Test No.</u>	<u>% Moisture Oven Dry</u>	<u>% Moisture Gauge</u>	
1-1B-95	4.8	5.0	
2-1B-95	5.4	6.9	
3-1B-95	4.9	6.3	
Average	5.0	6.1	

Calculate the moisture correction factor using the average % moisture oven dry and average % moisture gauge as follows:

$$\text{Moisture Correction Factor} = \left(\frac{\text{avg. \% moisture oven dry} - \text{avg. \% moisture gauge}}{100 + \text{avg. \% moisture gauge}} \right) \times 1000$$

Example:

Round to the nearest 0.01

$$\text{Moisture Correction Factor (M.C.F.)} = \left(\frac{5.0 - 6.1}{100 + 6.1} \right) \times 1000 = -10.37$$

Enter the moisture correction factor value into the moisture-density gauge as per the manufacturer's instruction manual. Pay close attention to the algebraic sign.

Once the density and moisture offsets have been entered into the moisture-density gauge, perform two “check tests” at two random locations with the offsets “enabled”. Check tests may be performed on the jobsite or an informational pad using representative material to ensure the results are within the maximum deviation tolerance as shown in Table 2.

Table 2
 Tolerances for Two Check Tests
 With Offsets Enabled

Maximum deviation is defined as the largest difference between any single moisture-density gauge test and sand cone test (at the same site) obtained during the check tests.

Maximum Deviation for Wet Density:

$\pm .032 \text{ Mg/m}^3$ ($\pm 2.0 \text{ lb/ft}^3$)

Check Tests
 (Gauge Correlation Check)

<u>Test No.</u>	<u>Sand Cone Wet Density</u>	<u>Nuclear Gauge Wet Density</u>	<u>Difference (\pm)</u>
4-1B-95	2.271 (141.7)	2.255 (140.7)	+ 0.016 (+ 1.0)
5-1B-95	2.256 (140.8)	2.239 (139.7)	+ 0.017 (+ 1.1)
Maximum Deviation for Wet Density: ($\pm 0.032 \text{ Mg/m}^3$ or $\pm 2.0 \text{ lb/ft}^3$ Allowable)			+ 0.017 (+ 1.1)

Check Test
 (Every 25 Compaction Test)

<u>Test No.</u>	<u>Sand Cone Wet Density</u>	<u>Nuclear Gauge Wet Density</u>	<u>Difference (\pm)</u>
10-1B-95	2.271 (141.7)	2.255 (140.7)	+ 0.016 (+ 1.0)
Maximum Deviation for Wet Density: ($\pm 0.032 \text{ Mg/m}^3$ or $\pm 2.0 \text{ lb/ft}^3$ Allowable)			+ 0.016 (+ 1.0)

NOTES PERTAINING TO MOISTURE-DENSITY GAUGE CORRELATION PROCEDURE

1. When performing the correlation tests, special attention should be given to ensure the sand cone tests and oven-dry moisture tests are completed carefully and accurately. If the soil is found to be non-uniform during the excavation of the sand cone test, or if the first two moisture-density gauge tests do not check within the 6% tolerance described in the PROCEDURE section, the test site should be abandoned and another site chosen for correlation test purposes.
2. Each correlation will consist of three moisture-density gauge tests and three sand cone tests.

3. Perform all three moisture-density gauge tests and sand cone tests (correlation tests), at the same time to avoid a deviation in the material. Once the density and moisture offsets have been determined and entered into the gauge, perform the moisture-density gauge tests and sand cone tests (check tests), to ensure the offsets were entered correctly, and that the correlation meets the maximum deviation specification for wet density (Table 2).
4. The two check tests for gauge correlation only need to be completed through the field density dry in accordance with Test Method Nev. T102 and this test method.
5. Once the moisture-density gauge is correlated, that moisture-density gauge correlation will be used until any of the conditions listed under RECORRELATION REQUIRED occur.
6. Correlation is gauge specific and will not be used for other gauges.
7. If the moisture-density gauge fails to meet the correlation tolerances, try to re-correlate the moisture-density gauge. If the moisture-density gauge re-correlation is still outside of the correlation tolerances, then sand cone Test Method Nev. T102 shall be performed on that material. There are no exceptions to the correlation procedure. Partial correlations will not be accepted.

PROCEDURE (3440 or 3450 SERIES GAUGES)

1. Use the moisture-density gauge for acceptance testing when a passing moisture-density gauge correlation has been accepted per the correlation tolerances.
2. Prior to performing the moisture-density gauge test, use the "Guide and Site Preparation Device" to clear away all loose surface material to obtain a smooth surface large enough to seat the moisture-density gauge. After the completion of compaction, where sheepsfoot and similar type compaction rollers have been used, remove the loose surface material to a depth of not less than 50 mm (2 in.) below the deepest disturbance by the rollers. If voids are present, fill them in using the material to be tested. Avoid building a pad, by using the 4.75 mm (No. 4) sieve to obtain the - 4.75 mm (- No. 4) material to smooth minor depressions or protrusions to a smoothness within ± 3 mm ($\pm 1/8$ in.).
3. Set the count time to one minute by pressing the "TIME" key. The screen will show "TIME: XX min 1 - 15 sec, 2 - 1 min, 3 - 4 min", press the "2" key to select one minute tests. The screen will then go back to the normal display.
4. Check the density and moisture offsets to make sure the proper correlation values are in the gauge for the material being tested. Press the "OFFSET" key and check.
5. Use the guide and drill rod to perforate a hole in the soil that is perpendicular to the surface. The hole shall be 50 mm (2 in.) deeper than the desired test depth. When using the guide and drill rod provided with the moisture-density gauge, the drill rod accounts for the extra 50 mm (2 in.). Place the drill rod through the extraction tool and insert into the scraper plate guide. Remove the drill rod by rotating and pulling up horizontally. Do not loosen the drill rod by tapping from side to side with a hammer. Care should be taken to avoid penetrating the lift below the material being tested.

6. Place source rod in the hole to the desired test depth. Ensure that the bottom of the moisture-density gauge is firmly seated and is in contact with the soil without rocking or tilting. Pull the moisture-density gauge backwards so the source rod is in firm contact with the side of the hole toward the scaler end of the moisture-density gauge.
7. Press the "START/ENTER" key. The screen will show "DEPTH: XX PR: XXXX, TIME: XX sec." After one minute, the counting will stop. The screen will show "%PR= XXX%, DD= XXX WD=XXX M=XX, %M=XX %VOIDS= XXXX". Record the wet density (WD), moisture (M), dry density (DD), and percent moisture (%M) on the appropriate form. Press the "SHIFT" key, then press the "COUNTS" key, and record the density counts and moisture counts. Rotate the moisture-density gauge 10 to 20 degrees and repeat this step. If the difference between the two density counts or the two moisture counts is less than or equal to 6% of the average of the two counts, then the average of these two tests constitutes one in-place test. The 6% rule is used to determine if the material under the moisture-density gauge is uniform.

Example:

Density Counts = 1486 and 1512

Moisture Counts = 69 and 64

$1512 - 1486 = 26$ (difference)

$69 - 64 = 5$ (difference)

$\frac{1486 + 1512}{2} = 1499$

$\frac{69 + 64}{2} = 67$

$1499 \times .06 = 90$ (maximum allowable)

$67 \times .06 = 4$ (maximum allowable)

* $26 \leq 90$

** $5 > 4$

* Density counts are within the 6% rule.

** Moisture counts are not within the 6% rule.

If either set of counts are not within this tolerance, obtain two additional one minute tests by rotating the moisture-density gauge each time to a new position. Rotate the moisture-density gauge 10 to 20 degrees to the left and right of the first two tested positions. In this case, the average of all four readings constitutes one in-place test and the 6% rule does not apply to the four sets of density counts and moisture counts.

RECORRELATION REQUIRED

The moisture-density gauge shall be re-correlated if any of the following occur:

- a. Change in project.
- b. Visual change in material or fails with the same compactive effort and moisture.
- c. Change in source of material.
- d. Check tests not within tolerances.
- e. Change in the moisture-density gauge.
- f. Moisture-density gauge is calibrated by Manufacturer or CRSO.
- g. Compaction readings are over 102 percent.
- h. At the discretion of the Engineer.
- i. If, at any time, a single check test is out of the $\pm 0.032 \text{ Mg/m}^3$ ($\pm 2.0 \text{ lb/ft}^3$) maximum deviation per Table 2, a new moisture-density gauge correlation is required.

TEST MAXIMUM DENSITY AND PERCENT RELATIVE COMPACTION

1. Obtain a representative sample of soil from the moisture-density gauge test site.
2. Determine the maximum dry density of the soil sample in accordance with Test Methods Nev. T104 and T108.
3. When the "SHIFT" and "% PR" buttons are pressed at the same time, the moisture-density gauge calculates the % relative compaction of the soil using the following formula:

$$\% \text{ Relative Compaction} = \left(\frac{\text{in-place dry density}}{\text{maximum dry density}} \right) \times 100$$

Note 2: Since there will always be at least two and sometimes four tests at each test site, % relative compaction will have to be calculated using the average of the dry densities from the site, divided by the maximum dry density of the particular material.

Note 3: In-place dry density is obtained by averaging the two or four in-place dry densities. Maximum dry density is obtained from Test Methods Nev. T104 and T108.

CHECK TEST

1. Every twenty five acceptance test performed with the moisture-density gauge will require a check of the moisture-density gauge correlation.
2. Run a single moisture-density gauge test and a sand cone test (refer to Figure 1 for correct positioning of the moisture-density gauge and sand cone test). It will also be required that a new calculated maximum dry density be determined. These tests shall be completed in accordance with Test Methods Nev. T102, T104, T108 and this test method.

3. During the check test, the gauge offsets must be enabled.
4. If the single correlation test between the moisture-density gauge and the sand cone test (wet densities) is not within the tolerance $\pm 0.032 \text{ Mg/m}^3$ ($\pm 2.0 \text{ lb/ft}^3$) listed in Table 2, a new correlation will be required.

NOTES

1. Under no circumstance is the moisture-density gauge (Troxler Model 3440) to be used for testing the compaction of concrete or plantmix bituminous surface. Excessive temperatures may cause serious damage to the gauge affecting its longevity and operating performance.
2. When the moisture-density gauge is within .6 m (2 ft) of any vertical object, a trench correction must be used for the moisture tests. Procedures for this setting are outlined in each individual gauge manual.
3. A total of 5 in-place densities (sand cones) are required to be performed for a valid Moisture/Density gauge correlation. A single maximum dry density determination as obtained per Test Method Nev. T108 may be utilized for all five locations.
4. Test Methods Nev. T104 and T108 must be performed whenever a second re-test is required.

REPORT

Report percent compaction to the nearest whole percent.

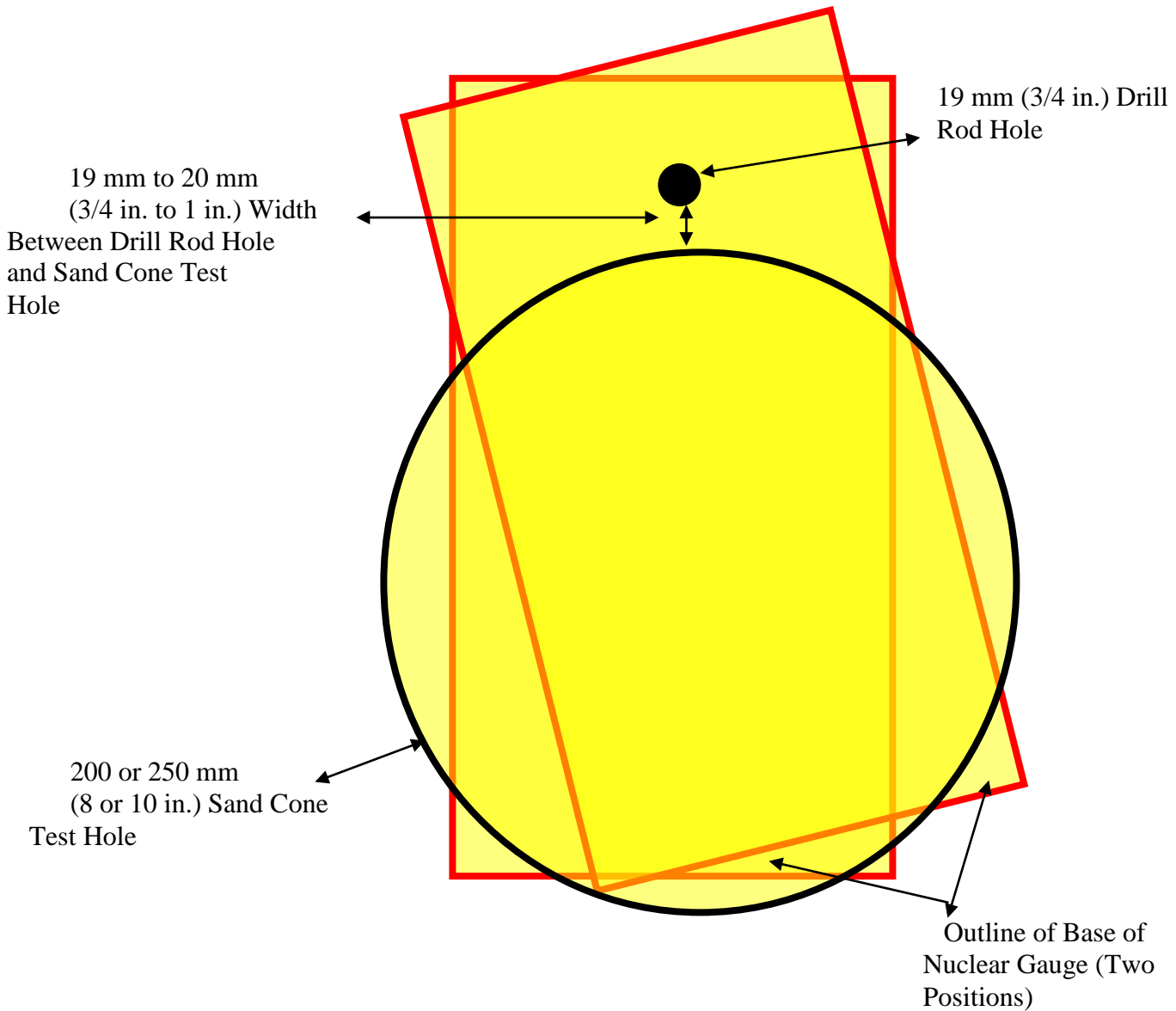

Correlation Test Site Location
Showing Relative Positions of the Moisture-Density Gauge and the Sand Cone Test

FIGURE 1

State of Nevada
Department of Transportation
Materials Division

METHOD OF TEST FOR APPARENT SPECIFIC GRAVITY OF COARSE AGGREGATES

SCOPE

This test method is used to determine the apparent specific gravity of aggregate particles retained on the 4.75 mm (No. 4) and larger sieve sizes.

APPARATUS

1. Balance, having a capacity of 12000 g and sensitive to 0.1 g.
2. Pycnometer, 1 L (1 qt) glass jar fitted with a conical lid having a small opening at the top of the cone.
3. Sieve, U.S. Standard, 4.75 mm (No. 4).

CALIBRATION OF PYCNOMETER

The pycnometer shall be cleaned, dried, and the weight (p) recorded to the nearest gram. Fill the pycnometer with room temperature water $25 \pm 5^{\circ}\text{C}$ ($77 \pm 9^{\circ}\text{F}$). Dislodge any air bubbles clinging to the inside of the pycnometer by gently tapping on the outside of the jar. Top off the pycnometer, forming a meniscus at the top of the opening on the conical lid. Dry the outside of the pycnometer. Weigh the pycnometer + water (p + M) and record to the nearest gram. The weight of the (pycnometer + water) - pycnometer = (M). Record (M) to the nearest gram.

PREPARATION OF SAMPLE

Use the 4.75 mm (No. 4) sieve to obtain a large enough wet sample that will allow for 500 g of dry + 4.75 mm (+ No. 4) material. Thoroughly wash the sample over a 4.75 mm (No. 4) sieve and dry in accordance with Test Method Nev. T112. Obtain 500 g of + 4.75 mm (+ No. 4) dry material (A) and record to the nearest gram.

PROCEDURE

1. Fill the pycnometer to approximately one third full of water before the sample is introduced, this will decrease the chances of breaking the jar. Place the sample in the pycnometer. Use caution not to lose any of the sample while transferring it to the pycnometer. Fill the pycnometer with room temperature water $25 \pm 5^{\circ}\text{C}$ ($77 \pm 9^{\circ}\text{F}$) to the top of the opening on the conical lid.
2. Remove entrapped air by placing a finger over the opening on the pycnometer lid while turning the pycnometer to a horizontal position, then rotating it in the hands. Set the pycnometer aside for a few minutes and repeat the rolling procedure. Removal of air bubbles clinging to the inside of the jar is facilitated by moving the jar so that aggregate particles slide across the side of the jar, dislodging the bubbles during the rolling process and by tapping the side of the jar after rolling is completed.
3. After removing entrapped air, add room temperature water $25 \pm 5^{\circ}\text{C}$ ($77 \pm 9^{\circ}\text{F}$) to refill the pycnometer, forming a meniscus at the top of the opening of the conical lid. Dry the outside of the pycnometer. Weigh the pycnometer + water + aggregate ($p + M + A$) and record to the nearest gram. The weight of the (pycnometer + water + aggregate) – (pycnometer + aggregate) = (M_1). Record (M_1) to the nearest gram.
4. Place a straw into the opening of the lid and pour off the water into a tared container, recovering as much of the water as possible. Weigh the water recovered from the pycnometer (M_2) and record to the nearest gram.
 - a. If the difference between the amount of water added (M_1) and the amount of water recovered (M_2) is 14 g or less, use Formula No. 1 under the “CALCULATIONS” Section, to calculate the apparent specific gravity.
 - b. If the difference between the amount of water added (M_1) and the amount of water recovered (M_2) exceeds 14 g, use Formula No. 2 under the “CALCULATIONS” Section, to calculate the apparent specific gravity.

CALCULATIONS

1. When $M_1 - M_2$ is less than or equal to 14 g:

$$\text{Apparent Specific Gravity} = \frac{A}{M - M_1}$$

2. When $M_1 - M_2$ is greater than 14 g:

$$\text{Apparent Specific Gravity} = \frac{A}{(M - M_1) + 0.5 (M_1 - M_2 - 14)}$$

Where:

A = Weight of dried aggregate

p = Weight of pycnometer

M = Weight of water used to calibrate pycnometer

M_1 = Weight of water used in pycnometer with sample

M_2 = Weight of water recovered from pycnometer and aggregate

REPORT

Report apparent specific gravity to the nearest 0.01.

State of Nevada
Department of Transportation
Materials Division

**METHOD OF TEST FOR THE DETERMINATION OF MAXIMUM DENSITY AND OPTIMUM
MOISTURE CONTENT OF SOILS USING THE MODIFIED PROCTOR DEVICE**

SCOPE

This test method is intended to determine the relationship between the moisture content and density of soils when compacted in a specified mold using a 4.54 kg (10 lb) rammer with a 457 mm (18 in.) drop. The maximum density and optimum moisture determined by this test shall be used for determining relative percent compaction in the field.

Method A applies to materials that have 40% or less retained on the 4.75 mm (No. 4) sieve. This value may be obtained from results determined per Test Method Nev. T206. Perform Test Method Nev. T206 to determine the percentage of the +4.75 mm (+No. 4) coarse aggregate.

Method D applies to materials that have 30% or less retained on the 19.0 mm (3/4 in.) sieve. This value may be obtained from results determined per Test Method Nev. T206. Perform Test Method Nev. T206 to determine the percentage of the +19.0 mm (+3/4 in.) coarse aggregate.

When both criteria are met for determining “Method A” and “Method D”, “Method A” shall be used.

For materials that do not otherwise require a sieve analysis to be performed, a representative sample shall be obtained, split, dried and screened through both a 4.75 mm (No. 4) and 19.0 mm (3/4 in.) to determine as to whether “Procedure Method A” or “Procedure Method D” is to be performed.

If the specified oversized maximum tolerances are exceeded, other methods of compaction control must be used.

APPARATUS

1. Mold, machined solid-wall metal cylinder having the dimensions as detailed in Table 1 or Table 2, a detachable collar and base plate to which the mold can be fastened to.
2. Rammer, mechanically or manually operated rammer as detailed in Table 1 or Table 2. A manually operated rammer shall be equipped with a suitable guide sleeve to control the path and height of the specified drop. The guide sleeve shall also be equipped with at least four vent holes no smaller than 9.5 mm (3/8 in.). A mechanically operated rammer shall be equipped with a device to uniformly distribute drops at specified heights.
3. Sample Extruder, jack, lever-frame, or other suitable device used for the purpose of extruding compacted specimens from the mold.

4. Balance, with a capacity of 12000 g and sensitive to 0.1 g.
5. Oven, capable of maintaining a temperature of 110 ± 5 °C (230 ± 9 °F).
6. Microwave, electric hot plate or gas stove.
7. Sieves, **Method A** - 4.75 mm (No. 4) or **Method D** - 19.0 mm (3/4 in.)
8. Straightedge, steel straightedge at least 250 mm (10 in.) in length, having one beveled edge and at least one plane surface, used for final trimming of the compacted specimen.
9. Mixing Tools, large mixing bowl, large pan, mixing spoon, scoop, tamper, trowel, spatula, hammer, etc. or other suitable devices for mixing the sample with water.

Table 1 (Metric)
Comparison of Apparatus, Sample, and Procedure

	Method A	Method D
Mold Volume, m ³	0.000943	0.002123
Mold Diameter, mm (Internal)	101.60 ± 0.41	152.40 ± 0.66
Mold Height, mm	116.43 ± 0.13	116.43 ± 0.13
Rammer Diameter, mm	50.80 ± 0.64	50.80 ± 0.64
Rammer Mass, kg	4.54 ± 0.01	4.54 ± 0.01
Lifts	5	5
Blows per Lift	25	56
Material Size, mm	4.75	19.0
Test Sample Size, kg	3.5	11.0
Rammer Drop Height, mm	457	457
Energy, kN-m/m ³	2,693	2,693

Table 2 (English)
Comparison of Apparatus, Sample, and Procedure

	Method A	Method D
Mold Volume, ft ³	0.0333	0.0750
Mold Diameter, in. (Internal)	4.00 ± 0.02	6.00 ± 0.03
Mold Height, in.	4.58 ± 0.01	4.58 ± 0.01
Rammer Diameter, in.	2.00 ± 0.03	2.00 ± 0.03
Rammer Mass, lb	10.0 ± 0.02	10.0 ± 0.02
Lifts	5	5
Blows per Lift	25	56
Material Size, in.	No. 4	¾"
Test Sample Size, lb	7.71	24.25
Rammer Drop Height, in.	18	18
Energy, lb-ft/ft ³	56,250	56,250

PROCEDURE – METHOD A

1. **Method A** - From a thoroughly blended sample as obtained per Test Method Nev. T200, thoroughly screen the blended sample over a 4.75 mm (No. 4) sieve. Split the remaining material passing the 4.75 mm (No. 4) sieve until a 3,500 g ± 350 g sample is obtained.
2. Squeeze a handful of material, and if a mold is formed which can be picked up readily with the thumb and index finger, sufficient moisture is present in the soil to begin the test. If a cast is not formed, add sufficient moisture to the sample at a rate not to exceed 2% of the total weight of the sample (depending on soil consistency) and mix thoroughly until the soil mixture appears uniform (ex. 3,500 g x .02 = 70 mL). Repeat this procedure until a sufficient moisture content for beginning the test is found. Cover the mixing bowl or pan with a damp cloth; keeping it covered throughout the test procedure. If the material is above its optimum moisture, it may be air dried or dried back in an oven not to exceed 60 °C (140 °F)
3. Determine the weight of the clean, dry mold. Include the base plate, but exclude the collar extension and record this weight to the nearest 1 g.
4. Form a specimen by compacting the prepared sample in the mold (with the collar extension attached) in 5 equal lifts. For each lift, uniformly spread the loose material in the mold and tamp it flat with the tamper. Compact each lift with 25 uniformly distributed blows from the rammer, dropping free from a height of 457 mm (18 in.). Make sure the fifth and final lift will leave the compacted soil surface in the collar approximately 6 mm (¼ in.) above the top of the mold.
5. Remove the extension collar using a twisting motion to avoid shearing off the sample below the top of the mold. Trim the compacted specimen even with the top of the mold using the beveled edge of the straightedge.

- Determine the weight of the compacted specimen, mold and base plate and record this weight to the nearest 1 g.
- Determine the weight of the compacted specimen by subtracting the weight of the mold as determined in Step 3 of this procedure.

$$\text{Wet Weight of Specimen} = (\text{Weight of Mold} + \text{Specimen}) - \text{Weight of Mold}$$

$$\text{Wet Density} = \text{Wet Weight of Specimen} / \text{Volume of Mold}$$

- Place the mold in the sample extruder and remove the compacted specimen. Cutting vertically through the center, take a representative sample (approx. 200g – 500g) from the full length and width of the specimen as illustrated in FIGURE 1. Separate the particles of the representative sample; place the sample in a suitable drying container and immediately record the weight of the wet sample to the nearest 0.1 g. Dry the sample in accordance with Test Method Nev. T112.
- Break up the remaining portion of the compacted specimen until it will pass through a 4.75 mm (No. 4) sieve and recombine it with the remaining portion of the sample in the mixing bowl or pan being tested. Thoroughly blend the sample in a mixing bowl or pan and add 2 percent water at 25 ± 5 °C (77 ± 9 °F) NOTE: (1 mL = 1 g).
- Continue to repeat the procedures as outlined in Step 4 thru Step 9 until there is either a decrease or no change in the wet density of the compacted specimen. With moisture additions in increments of 2 %, multiple determinations may be necessary to determine a materials maximum dry density.
- Dry all specimens using one of the methods outlined in Test Method Nev. T112 or by the following microwave oven procedure: Place a 600 mL glass beaker or other suitable container filled with approximately 300 mL of water (maintain water level during drying) into the microwave oven to prevent overheating during the drying process. Place specimen in a microwave safe container, then place in the microwave oven. Dry the sample for 5 minutes, then at 2 minute intervals until a constant weight is achieved. Drying times may be adjusted based on type and size of the microwave oven.
- At the completion of the drying procedure, allow specimens to cool. Weigh and record the dry weight of each specimen to the nearest 0.1 g, then calculate the percent moisture to the nearest 0.1%.

$$\% \text{ Moisture} = [(\text{Wet Weight of Specimen} - \text{Dry Weight of Specimen}) / (\text{Dry})] \times 100$$

$$\text{Dry Density} = [(\text{Wet Density}) / (100 + \% \text{ Moisture})] \times 100$$

PROCEDURE – METHOD D

1. **Method D** - From a thoroughly blended sample as obtained per Test Method Nev. T200, thoroughly screen the blended sample over a 19.0 mm (3/4 in.) sieve. Split the remaining material passing the 19.0 mm (3/4 in.) sieve until an 11,000 g \pm 1,100 g sample is obtained.
2. Squeeze a handful of material, and if a mold is formed which can be picked up readily with the thumb and index finger, sufficient moisture is present in the soil to begin the test. If a cast is not formed, add sufficient moisture to the sample at a rate not to exceed 2% of the total weight of the sample (depending on soil consistency) and mix thoroughly until the soil mixture appears uniform (ex. 11,000 g x .02 = 220 mL). Repeat this procedure until a sufficient moisture content for beginning the test is found. Cover the mixing bowl or pan with a damp cloth; keeping it covered throughout the test procedure. If the material is above its optimum moisture, it may be air dried or dried back in an oven not to exceed 60 °C (140 °F)
3. Determine the weight of the clean, dry mold. Include the base plate, but exclude the collar extension and record this weight to the nearest 1 g.
4. Form a specimen by compacting the prepared sample in the mold (with the collar extension attached) in 5 equal lifts. For each lift, uniformly spread the loose material in the mold and tamp it flat with the tamper. Compact each lift with 56 uniformly distributed blows from the rammer, dropping free from a height of 457 mm (18 in.). Make sure the fifth and final lift will leave the compacted soil surface in the collar approximately 6 mm (1/4 in.) above the top of the mold.
5. Remove the extension collar using a twisting motion to avoid shearing off the sample below the top of the mold. Trim the compacted specimen even with the top of the mold using the beveled edge of the straightedge.
6. Determine the weight of the compacted specimen, mold and base plate and record this weight to the nearest 1 g.
7. Determine the weight of the compacted specimen by subtracting the weight of the mold as determined in Step 3 of this procedure.

$$\text{Wet Weight of Specimen} = (\text{Weight of Mold} + \text{Specimen}) - \text{Weight of Mold}$$

$$\text{Wet Density} = \text{Wet Weight of Specimen} / \text{Volume of Mold}$$

8. Place the mold in the sample extruder and remove the compacted specimen. Cutting vertically through the center, take a representative sample (approx. 200g – 500g) from the full length and width of the specimen as illustrated in FIGURE 1. Separate the particles of the representative sample; place the sample in a suitable drying container and immediately record the weight of the wet sample to the nearest 0.1 g. Dry the sample in accordance with Test Method Nev. T112.
9. Break up the remaining portion of the compacted specimen until it will pass through a 19.0 mm (3/4 in.) sieve and recombine it with the remaining portion of the sample in the mixing bowl or pan being tested. Thoroughly blend the sample in a mixing bowl or pan and add 2 percent water at 25 \pm 5 °C (77 \pm 9 °F) NOTE: (1 mL = 1 g).

10. Continue to repeat the procedures as outlined in Step 4 thru Step 9 until there is either a decrease or no change in the wet density of the compacted specimen. With moisture additions in increments of 2 %, multiple determinations may be necessary to determine a materials maximum dry density.
11. Dry all specimens using one of the methods outlined in Test Method Nev. T112 or by the following microwave oven procedure: Place a 600 mL glass beaker or other suitable container filled with approximately 300 mL of water (maintain water level during drying) into the microwave oven to prevent overheating during the drying process. Place specimen in a microwave safe container, then place in the microwave oven. Dry the sample for 5 minutes, then at 2 minute intervals until a constant weight is achieved. Drying times may be adjusted based on type and size of the microwave oven.
12. At the completion of the drying procedure, allow specimens to cool. Weigh and record the dry weight of each specimen to the nearest 0.1 g, then calculate the percent moisture to the nearest 0.1%.

$$\% \text{ Moisture} = [(\text{Wet Weight of Specimen} - \text{Dry Weight of Specimen}) / (\text{Dry})] \times 100$$

$$\text{Dry Density} = [(\text{Wet Density}) / (100 + \% \text{ Moisture})] \times 100$$

MOISTURE-DENSITY RELATIONSHIP

1. Calculations shall be made to determine a materials wet density (unit mass) and oven-dry density (unit mass). The oven-dry densities of the soil shall be plotted as ordinates (y-axis) and corresponding moisture contents as abscissa (x-axis).
2. When the densities and corresponding moisture contents for the soil sample have been determined and plotted, it shall be found that by connecting the plotted points with a smooth line, a curve is produced. The moisture content corresponding to the peak of the curve shall be termed the “optimum moisture content.”
3. The oven-dry density in kilograms per cubic meter or pounds per cubic foot of the soil at optimum moisture content shall be termed “maximum density” under the above compaction.

COARSE AGGREGATE CORRECTION

Method A, When the test specimen contains material exceeding 5 percent by mass retained on the 4.75 mm (No.4) sieve, use the following “Coarse Aggregate Correction” calculations. Use Test Method Nev. T104 to determine the apparent specific gravity of the +4.75 mm (+No. 4) aggregate. Use the percent of +No. 4 aggregate as determined per Test Method Nev. T206.

Method D, When the test specimen contains material exceeding 5 percent by mass retained on the 19.0 mm (3/4 in.) sieve, use the following “Coarse Aggregate Correction” calculations. Use Test Method Nev. T104 to determine the apparent specific gravity of the +19.0 mm (+3/4 in.) aggregate. Use the percent of +3/4 in. aggregate as determined per Test Method Nev. T206.

Correction for the +4.75 mm (+No.4) or +19.0 mm (+3/4 in.) material shall be calculated as follows:

$$D = \frac{dG}{(d)(1-P) + (G)(P)}$$

Example:	D	= Corrected Calculated Max. Density	
	d	= Maximum Dry Density	140.4 lbs/ft ³
	1- P	= Percent +No.4 or +3/4 in. Aggregate	(0.27) 27%
	P	= Percent -No.4 or -3/4 in. Aggregate	(0.73) 73%
		Apparent Specific Gravity of Coarse Aggregate	2.70
	G	= Mass per Volume of Coarse Aggregate: (2.70 x 62.4)	168.5 lb/ft ³

$$D = \frac{(140.4 \text{ lb/ft}^3) \times (168.5 \text{ lb/ft}^3)}{[(140.4 \text{ lb/ft}^3 \times 0.27) + (168.5 \text{ lb/ft}^3 \times 0.73)]}$$

$$D = 147.0 \text{ lb/ft}^3$$

Corrected Optimum Moisture Calculation:

$$[(1-P) \times 2] + [P \times \text{Test Opt. Moisture}]$$

REPORT

Report optimum moisture content or corrected optimum moisture content to the nearest 0.1% and maximum density or corrected maximum density to the nearest 0.1 lb/ft³

NOTES

1. When preparing the initial sample, thoroughly mix with a sufficient amount of water to moisture condition it to approximately three percentage points below the samples optimum moisture content.
2. It's important to place the loose material into the mold and spreading it into a layer of uniform thickness and tamp it with the tamper prior to the compaction of each lift. Do not allow material to build up the sides of the mold between lifts. If this occurs, break down and tamp the material before the final blow is completed or before the next lift is started.
3. When completing a Proctor Compaction Curve Test on gypsum or material blended with recycled asphalt pavement, dry in accordance with Test Method Nev. T112, Method A, under "PROCEDURE", using a temperature of 60 °C (140 °F), to avoid changing the nature of the sample.
4. A valid Modified Proctor Test shall consist of a minimum of three points for the maximum dry density determination consisting of one point below optimum, one near optimum and one over optimum.
5. A new Proctor Curve Test shall be performed whenever results indicate changes to materials, a second re-test is required, test results exceeding 102% compaction or at the discretion of the Resident Engineer.
6. Percentages retained on the +4.75 mm (+No. 4) and +19.0 mm (+3/4 in.) should be determined each time a Proctor Curve is performed to verify that the correct method is being utilized as described in the SCOPE of this Method.
7. In instances where soil materials indicate fragile characteristics (such as the breaking of aggregate) that will reduce significantly by repeated compaction, a separate and new sample shall be used for each compaction test.

When utilizing "Method A", obtain a minimum of three separate samples approximately 2,500 g as described in Step 1 of "PROCEDURE – METHOD A". Each individual sample shall represent one compaction test after it has been properly moisture conditioned in increments of 2%.

When utilizing "Method D", obtain a minimum of three separate samples approximately 5,500 g as described in Step 1 of "PROCEDURE – METHOD D". Each individual sample shall represent one compaction test after it has been properly moisture conditioned in increments of 2%.

8. When developing a compaction curve for free draining soils, such as uniform sands and gravels, where seepage occurs at the bottom of the mold and base plate, taking a representative moisture sample from the mixing bowl shall be acceptable.

9. Do not use the hammer to extract the material from the mold.

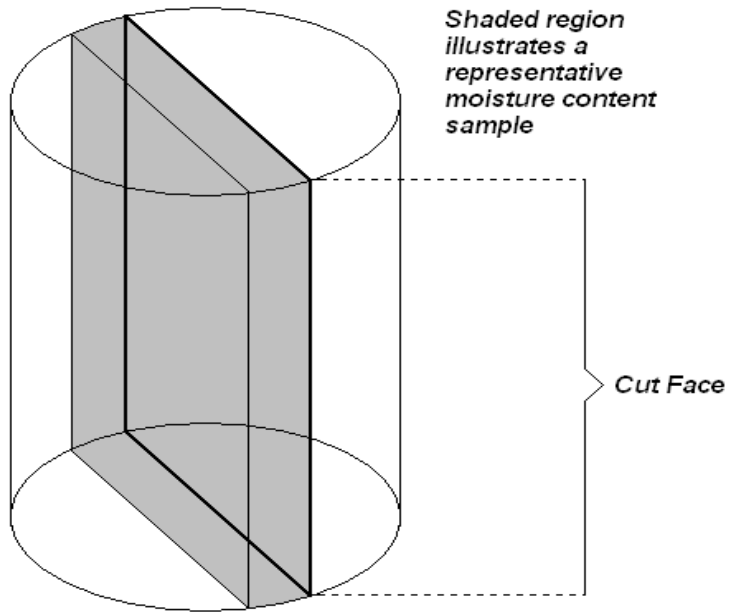

FIGURE 1

State of Nevada
Department of Transportation
Materials and Testing Division

METHOD OF TEST FOR SPECIFIC GRAVITY
AND ABSORPTION OF COARSE AGGREGATE

SCOPE

This test method, which is a modification of AASHTO Designation T85, specifies procedures for the determination of the bulk and apparent specific gravity, and absorption of coarse aggregates, and is designed for the use in the Headquarters, Progress, and Field Laboratories.

The oven-dry basis calculation for bulk specific gravity shall be used for the determination of the specific gravity of riprap aggregates, and is also used for bituminous mix aggregates. The saturated surface-dry basis calculation for bulk specific gravity is used for portland cement concrete aggregates. The apparent specific gravity is used in determining the calculated maximum density, Nev. T101

A. APPARATUS

1. A balance having a capacity of at least 5,500 g. and sensitive to 0.5 g. or less and accurate within 0.1 percent of the test load at any point within the range used for the test.
2. A wire basket made of 3.35mm (No. 6) or 2.36mm (No. 8) mesh, and dimensions such that the basket will have sufficient capacity for samples up to 5,500 g. maximum. A generally satisfactory size is 203.2mm x 203.2mm x 114.3mm (8 x 8 x 4-1/2 in.) deep.
3. A container of sufficient size to allow the wire mesh basket to be completely immersed. A copper tank, 292.1mm x 355.5mm x 203.2mm (11-1/2 x 14 x 8 in.) deep is satisfactory for the 203.1mm sq. (8-in. sq.) basket described above.
4. Suitable apparatus for suspending the immersed basket from the balance so that the weight of the aggregate in water can be obtained.
5. Vessels, each of approximately 7.6 liters (2-gallon) capacity, that are deep enough to permit immersing entire sample during soaking period.

B. TEST RECORD FORM

Record the test data on worksheet

C. PREPARATION OF SAMPLE

Obtain approximately 5,000 g. of the coarse aggregate (retained on 4.75 mm (No. 4) sieve) either by careful quartering or by the use of an accurate mechanical sample reducer. (Refer to Test Method Nev. T203.)

D. TEST PROCEDURE

1. Place sample in vessel, cover with water at a temperature of $23 \pm 1.7^{\circ}$ C. ($73.4 \pm 3^{\circ}$ F.) and allow to soak for a minimum period of 15 hrs.
2. Pour sample into wire basket, rinse clean, suspend the wire basket from the center of the balance scale pan, immerse basket completely in the water at $23 \pm 1.7^{\circ}$ C. ($73.4 \pm 3^{\circ}$ F.) use suitable tare weight, and weigh to nearest gram. Record weight as Weight of Sample in Water.
3. Remove basket, drain off free water for a few seconds, then pour sample out of basket onto large absorbent cloth, and roll the sample in the cloth until all visible films of water are removed, although the surface of the particles may still appear to be damp. Large aggregate particles may be individually wiped in lieu of rolling in cloth. In order to avoid evaporation of absorbed water, perform this surface drying operation as rapidly as possible and then immediately weigh to the nearest gram. Record weight as Weight of Saturated Surface-dry Sample in air.
4. Pour sample into suitable drying pan, dry sample to constant weight in oven at a temperature of $110 \pm 5^{\circ}$ C. ($230 \pm 9^{\circ}$ F.), cool to room temperature, for 1 to 3 hours, pour sample into balance, use suitable tare weight, and weigh to nearest gram. Record weight as Oven-dry Weight.

E. CALCULATIONS

1. Calculate the bulk specific gravity, oven-dry basis, from the following formula:

$$\text{Bulk specific gravity (oven-dry basis)} = \frac{A}{B - C}$$

Where:

A= weight in grams of sample in oven-dry condition

B= weight in grams of sample in saturated surface-dry condition, and

C= weight in grams of saturated sample immersed in water

2. Calculate the bulk specific gravity, saturated surface-dry basis, from the following formula:

$$\text{Bulk specific gravity (saturated surface-dry basis)} = \frac{B}{B - C}$$

3. Calculate the apparent specific gravity from the following formula:

$$\text{Apparent specific gravity} = \frac{A}{A - C}$$

4. Calculate the percentage of absorption from the following formula:

$$\text{Percent absorption} = \frac{B - A}{A} \times 100$$

F. PRECAUTIONS

When tare weights are used to compensate the weight of the basket and/or apparatus used to suspend the basket from the balance, be certain the correct tare weight is used.

G. REPORTING THE RESULTS

Report the specific gravities to the nearest hundredth (2.65, 2.52, etc.), and absorptions to the nearest tenth (1.4, 2.3, etc.).

Test Method Rev. T111D

REFERENCE

AASHTO Designation T85

State of Nevada
Department of Transportation
Materials Division

METHOD OF TEST FOR MOISTURE CONTENT IN SOILS AND AGGREGATES

SCOPE

This test method is used to determine the percent of moisture in soil or aggregate samples where rapid determinations of moisture contents are necessary. The moisture content is expressed as the percentage by weight of the dry material.

Alternative methods identified as Method A and B are provided. Method A, "Thermostatically Controlled Oven", is used for standard moisture content or in the event of a dispute (referee method). Method B, "Hot Plate or Gas Stove", is used for rapid determination of moisture content.

APPARATUS

1. Balance, having a capacity of 12000 g and sensitive to 0.1 g.
2. Oven, capable of maintaining a temperature of $110 \pm 5^{\circ}\text{C}$ ($230 \pm 9^{\circ}\text{F}$).
3. Electric hot plate or gas stove.
4. Sample containers, any suitable container with a lid that will prevent loss of moisture during transport.
5. Drying pans, trowels, spoons, spatulas, gloves, safety glasses, etc.

SAMPLING

Sample in accordance with Test Method Nev. T200.

PREPARATION OF SAMPLE

1. Samples shall be transported in covered and sealed containers to prevent moisture loss. Do not remove sample until material is ready to be tested. All samples should be tested within 1 hour of sampling.
2. Obtain a representative sample in accordance with Test Method Nev. T203, with as little handling of the material as possible to avoid moisture loss due to evaporation.

3. The size of sample for Method A or B shall be a 1000 g minimum for material up to 25 mm (1 in.) maximum size. For all larger sizes, the size of the moisture sample shall be 2000 g minimum.

PROCEDURE

METHOD A (Thermostatically Controlled Oven), referee method

1. Weigh wet sample and record to the nearest 1 g.
2. Spread sample uniformly in drying pan and dry for a minimum of 12 hours and until a constant weight has been achieved, using a thermostatically controlled oven at $110 \pm 5^{\circ}\text{C}$ ($230 \pm 9^{\circ}\text{F}$). Drying time is influenced by soil type, size of the sample and number of samples in the drying oven.
3. Remove dry sample from the oven and allow it to cool to room temperature.
4. Weigh dry sample and record to the nearest 1 g.

METHOD B (Hot Plate or Gas Stove Method)

1. Weigh wet sample and record to the nearest 1 g.
2. Spread material uniformly in a drying pan and dry to a constant weight on a hot plate or gas stove, taking care not to burn the material. Stir the sample frequently to ensure complete and uniform drying. Avoid temperatures at which free water boils violently, causing material to spatter out of the pan, or the rock particles containing entrapped moisture to fracture.
3. Remove dry sample from the hot plate or gas stove and allow it to cool to room temperature.
4. Weigh dry sample and record to the nearest 1 g.

CALCULATIONS

1. Calculate the moisture content using the following formula:

$$\% \text{ Moisture} = \left(\frac{\text{wet weight} - \text{dry weight}}{\text{dry weight}} \right) \times 100$$

REPORT

Report moisture content to the nearest 0.1 percent.

PRECAUTIONS

When obtaining a moisture content for gypsum or recycled asphalt pavement material (rap material), dry in accordance with Method A, under “PROCEDURE”, using a temperature of 60°C (140°F), to avoid changing the nature of the sample.

State of Nevada
Department of Transportation
Materials Division

**STANDARD METHODS OF SAMPLING STONE, GRAVEL,
SAND AND PAVING MIXTURES FOR USE AS HIGHWAY MATERIALS**

SCOPE

This test method is used to obtain a representative sample of stone, gravel, sand and certain paving mixtures for the following purposes:

- Preliminary investigation of sources of materials.
- Acceptance or rejection of sources of materials.
- Inspection of shipments of materials.
- Inspection of materials on the site of work.

Some types of materials covered by this method are base aggregates, aggregates for bituminous courses, aggregates for portland cement products, plantmix and roadmix bituminous paving mixtures, and portland cement treated base mixtures.

Representative sample is defined as obtaining material in the same proportion as they will exist or will be used. Good sampling practices must be used throughout the entire sampling and transporting process.

APPARATUS

1. Sample Containers, metal bucket, plastic bucket, 12” cylinders mold, or canvas sample sack of sufficient size to obtain required sample size.

NOTE: Metal buckets, are used to sample plantmix; 12” cylinder molds, to give a split of a plantmix sample to Materials Division or IA Lab. Plastic containers, are used to sample soils and aggregates. Canvas sample sacks are used to sample for mix designs and source required tests.

2. Shovel or Scoop, square point shovel, bullnose shovel or scoop with a handle long enough to permit proper sampling. Sampling equipment must be clean to prevent contamination of material being sampled.

SECURING SAMPLES

1. All acceptance test samples shall be obtained by or observed by the Engineer or their authorized representative. Samples for informational tests may be submitted by the contractor, seller or owner of the supply.
2. Sampling is as important as the testing procedure. The sampler shall use every precaution to obtain samples that will show the true nature and condition of the materials that they represent.

PROCEDURE

Stone from Ledges or Quarries

1. Inspect the ledge or quarry face of the stone to determine any variation in different strata.
2. Obtain separate samples of stone from all strata that appear to vary in color and structure. Include overburden as a separate sample.
3. Each sample should weigh at least 23 kg (50 lbs) and should consist of specimens that are not obviously weathered beyond a degree of usefulness for the purposes intended.
4. When the toughness or compression test is required, include one piece in each sample of not less than 150 mm x 150 mm x 100 mm (6in. x 6in. x 4in.) in size with the bedding plane clearly marked. This piece should be free of seams or fractures.
5. Pieces that have been damaged by blasting shall not be included in the sample.

Field Stone and Boulders

Carefully inspect the deposits of field stone and boulders over the area where the supply is to be obtained. Note and record the different kinds of stone and the condition in the various deposits.

1. Select separate samples of all classes of stone that visual inspection indicates would be considered for use in construction. Individual samples shall weigh at least 23 kg (50 lbs).
2. Estimate and record the percentages of different classes of stone that were sampled, and the percentages of material that can be rejected by visual examination and may therefore have to be handled and rejected.

Deposits of Sand and Gravel

1. If the deposit is worked as an open-face bank or pit, take the sample by channeling the face vertically, top to bottom, to obtain sample from the vertical face, starting from the top and channeling towards the bottom so the sample will be representative of the material to be used.
2. If visual inspection indicates that there is considerable variation in the material, select individual samples to represent the material in each well-defined stratum. Include overburden or disturbed material as a separate sample. Note and record the elevations of the individual strata.
3. Where there is little or no variation in the material, obtain a large sample from each test location and reduce to the proper size by thorough mixing and quartering.
4. If the deposit does not have an exposed face, or if samples are desired in other parts of a proposed deposit; excavate or drill test holes at numerous locations to determine the quality of the material and the extent of the deposit. The number and depth of these test holes will depend on the quantity of the material needed, topography of the area, nature of the deposit, as well as the character of the material and value of the resultant product.
5. Size of the samples shall be such that at least 12 kg (25 lbs) of sand and 34 kg (75 lbs) of gravel are available for tests, if both are present.
6. Estimate the quantity of the different materials that are available in the deposit.

Stockpiles

1. Sample at the top, middle and bottom around the circumference of the stockpile from a minimum of three locations. Do not sample exposed material. Be aware of the segregation that usually occurs when material is stockpiled, with the coarser particles rolling to the outside base of the pile.
2. Insert a board or sign of sufficient size into the pile above the point of sampling to aid in preventing further segregation during sampling.
3. Be sure to remove the top layer of material before sampling.
4. When possible, use power equipment to expose various levels of the stockpile. Ensure material is mixed by the power equipment before a pad is made.

NOTE: Samples may be tested individually to show the extent of variation existing in the stockpile. Samples may be combined to form a composite sample to demonstrate the overall quality of the stockpile.

Conveyor Belt

Safety Precautions: Notify plant operator that a belt sample needs to be obtained. If the conveyor belt is not equipped with an automatic sampling device the following safety precautions need to be followed.

Conveyor belt shall be stopped and proper lock out tag out procedures followed.

Appropriate access to the conveyor belt shall be given to person(s) obtaining the belt sample. Platform that is MSHA or OSHA approved shall also be provided. If necessary, engineer or their authorized representative can witness sample being taken.

1. Sample aggregate when the plant is in full production and there is a uniform layer of material on the belt. Stop the belt with material on it, before sampling.
2. Sample from the entire width of the belt. Use a metal template, shaped to fit the contour of the belt, to isolate the sample and to prevent segregation during sampling.
3. Use a brush to collect all fines.
4. Sample a minimum of three locations from the belt. Combine portions to form one composite sample.

Storage Bins

1. Sample from the bin as the material is being discharged.
2. Allow sufficient material to flow before sampling to insure normal uniformity.
3. Sample from the complete cross section of flow.

Transport Vehicles

1. Use the following procedure for trucks, railroad cars or any other uncovered vehicle.
2. Make three or more trenches across the width of the load.
 - a. The bottom of the trench should be at least one foot below the surface of the aggregate at the sides of the vehicle and approximately one foot wide at the bottom.
 - b. The bottom of the trench should be as level as possible.
3. Obtain approximately five equal portions from within the trench; sampling at equally spaced intervals with two portions being sampled near outer sides of transport vehicle.
4. Sample size shall be as outlined in the Table 1.

Processed Windrows

1. Remove the top one-half of the windrow by cutting a trench across the width of the windrow.
 - a. Slope the sides of the trench to prevent segregation during sampling.
 - b. Remove all disturbed material from the sampling area.
 - c. Strike off the ends of the trench vertically with the blade of the shovel.
2. Sample the full length of the trench as prepared above.
 - a. Remove material to a depth of at least one and one-half times the maximum size of the particles.
 - b. Sample from each end of the trench toward the center.
3. Sample a minimum of three locations from the windrow. Combine portions to create one composite sample.

Paving Machine

1. Sample from the front of paving machine or in front of the auger before spreading and screeding.
2. Collect the sample at intervals to represent an entire truckload of material.
3. Obtain the sample from both sides of the paving machine.

Roadbed, behind laydown machine

1. Take samples from the roadbed behind the laydown machine and prior to compaction.
2. Fill up the metal buckets with material from the auger to fill in the holes from obtaining the composite sample.
3. Take three samples of material deposited from one truckload and combine to form a single composite sample.
 - a. Samples shall be taken from the first, middle and last portions of the load.
 - b. Samples shall be taken diagonally across the mat at equal portions from the left, center and right segments of the placement and far enough apart to represent one truck load of material.
 - c. Using a shovel or scoop remove material in a neat, clean-cut hole to prevent segregation. Remove all loose particles to the full depth of placement, making sure not to get into underlying mat. (If sample is excessively contaminated with underlying material, obtain another sample).

Sampling with Mechanical Device

1. Plants may be equipped with some type of mechanical device for securing samples of the finished product prior to or as the material leaves the conveyor belt.
2. Ensure the device takes all of the material or the device goes all the way through the stream of material to obtain a representative sample.

NUMBER AND SIZE OF SAMPLES

1. The number of samples required depends on the intended use of material, quantity of material involved and variations in the material. A sufficient number of samples must be obtained, as outlined above, to cover all variations in the material. Where multiple samples are taken to show variation, each sample shall conform to sample size as outlined in Table 1.
3. Frequencies and sample locations for sampling processed construction materials in the field are set forth in the State of Nevada Department of Transportation Construction Manual, Section 5.
4. The sample sizes set forth below are tentative. Quantities must be based on the type and number of tests to which the material is to be subjected and sufficient material obtained to provide for proper execution of all required tests. The minimum amount depends on maximum size of the particles, as follows:

TABLE 1 – SIZE OF SAMPLE

Nominal Maximum Size of Particles, Passing Sieve	Minimum Weight of Field Sample, Kgs (lbs)
2.00 mm (No. 10)	5 kg (10 lbs)
4.75 mm (No. 4)	5 kg (10 lbs)
9.75 mm (3/8")	5 kg (10 lbs)
12.50 mm (1/2")	10 kg (20 lbs)
19.00 mm (3/4")	15 kg (30 lbs)
25.00 mm (1.0")	25 kg (50 lbs)
37.00 mm (1-1/2")	30 kg (70 lbs)
50.00mm (2.0 ")	40 kg (90 lbs)
63.00mm (2-1/2")	45 kg (100 lbs)
75.00 mm (3.0")	60 kg (125lbs)
90.00mm (3-1/2")	65 kg (150 lbs)

5. Field samples of bituminous material and cement treated mixtures taken from the roadbed behind the paver, shall not be less than 1000 cm² (144 in²) of pavement surface area, and shall extend the full depth of the course of material placed.

MARKING AND SHIPPING SAMPLES

1. Immediately upon sampling, samples shall be placed in approved sample sacks or buckets and covered or sealed to prevent contamination or loss of fines. Label each canvas sample sack and bucket at the time of sampling.
2. Each canvas sample sack of material submitted to the Materials lab for testing shall be accompanied by NDOT form 020-018.
3. In addition to the transmittal form inside the canvas sample sack, label the outside of the canvas sample sack with a brief description of the contents which includes the material type, contract number, date sampled, and if more than one bag of the same material is sampled label it bag 1 of 2 or 2 of 2 etc. Also include a copy of all minimum required tests ran by the construction field lab.

NOTE: All minimum required tests should have passing results before submitting to the Materials Lab.

State of Nevada
Department of Transportation
Materials Division

METHOD OF TEST FOR REDUCING A REPRESENTATIVE TEST SAMPLE OF SOIL AND AGGREGATE

SCOPE

This test method describes the process of reducing soil and aggregate samples for required tests from larger field samples obtained from Test Method Nev. T200.

APPARATUS

1. Splitter, device which will divide the sample into representative portions (Figure 1, 2 and 3).
2. Sample Containers, glass pyrex dish, metal sample pan, metal bowl, metal dog dish, porcelain bowl etc.
3. Quartering Canvas, wooden stick, pipe, paint brush
4. Crusher, which can be adjusted to produce material passing the 4.75 mm (No. 4) sieve. A sledge hammer may be used to reduce oversize particles enough to permit the material to be fed into the crusher.

SAMPLE IDENTIFICATION

Each sample shall be properly labeled to easily identify the type of material, contract number, date, source and tests required.

SECURING REPRESENTATIVE SAMPLE

Refer to the respective test methods and specifications for the quantity of material needed.

Split or quarter the sample into representative portions for various tests. The riffle type splitter is preferable to hand quartering, however, hand quartering is acceptable, if carefully performed. Do not scoop or pour material directly from sample container without properly reducing for testing.

Split or quarter material in a damp condition, to avoid the loss of fine material (to dry) and to avoid clumping of wet material (to wet), ensuring a representative split sample is being obtained.

1. Mechanical device (Riffle Splitter)

The splitting device should have openings sufficiently wide enough to permit easy passage of the largest particles in the sample and yet not so wide that a non-representative separation is obtained. Generally, the width of openings should be approximately 50 percent larger than the largest particles in the sample to be split.

- a. Thoroughly mix the sample and spread it evenly across the pan or hopper. The pan or hopper used with a riffle type splitter shall be equal in width to the overall width of the chutes so that the material will pour in equal amounts into each chute. Do not pour samples directly into chutes from anything other than the pan described above.
- b. Holding the pan in a horizontal position in regards to the riffle splitter, dump the pan in a horizontal twisting motion into the top of the riffle splitter, allowing the material to slowly slide into the catch pans under the riffle splitter. If there is a hopper pull the lever and allow the material to slowly slide into the catch pans under the riffle splitter.
- c. Take one pan and place it in the original sample container. Place the two empty pans back under the riffle splitter. Take the pan with material still in it and dump the pan in a horizontal twisting motion into the top of the riffle splitter, allowing the material to slowly slide into the catch pans under the riffle splitter. If there is a hopper pull the lever and allow the material to slowly slide into the catch pans under the riffle splitter.
- d. Repeat this procedure until the desired sample size is obtained for the various tests.

NOTE: To increase the accuracy of the splitting method ensure a representative sample for testing, “double split” the samples. This procedure involves quartering the original sample into four equal parts, then combining opposite quarters.

2. Hand quartering of samples weighing over 45 kg (100 lb).

- a. Mix and pile the sample onto a level quartering canvas. Shovel the material into the center to form a cone. Place each shovelful so that the material spills over the cone equally in all directions to mix the sample. Dampen samples (except samples for moisture) that tend to segregate before proceeding with the following steps.
- b. Flatten the cone with a shovel, spreading the material into a circular layer of uniform thickness.
- c. Insert a device that will aid in the lifting of the canvas such as a stick, pipe or other suitable device. Place the device beneath the canvas and under the center of the pile, and then lift both ends of the device, dividing the sample into two equal parts. Remove the device, leaving a fold of canvas between the divided portions.
- d. Insert the device under the center of the pile perpendicular to the first division and again lift both ends of the device, dividing the sample into four parts.

- e. Remove two diagonally opposite quarters, being careful to clean the fines from the canvas.
 - f. Remix the remaining material by taking alternate shovelfuls from each remaining quarter and placing it in the center so that a cone is formed as before. Repeat the quartering process until the sample is reduced to the desired size.
3. Hand quartering of samples weighing 11 kg to 45 kg (25 to 100 lb).
 - a. Pile the sample on the canvas and mix by alternately lifting each corner of the canvas and pulling it over the sample toward the diagonally opposite corner, causing the material to be rolled. Dampen materials that tend to segregate.
 - b. Flatten and quarter as specified above.
 4. Hand quartering of samples weighing less than 11 kg (25 lb).
 - a. Place the sample on a clean canvas, clean table, clean sheet of heavy paper or other suitable surface. Mix thoroughly with a trowel and form the material into a conical pile. Dampen materials that tend to segregate.
 - b. Flatten the cone by pressing it down with a trowel.
 - c. Separate into quarters with the trowel and remove diagonally opposite quarters.
 - d. Repeat the above process until the sample is reduced to the desired size.

After the required test samples have been removed, save the remainder of the sample for possible future tests.

PRECAUTIONS

1. Once a sample splitter is used for plantmix, it shall be used for plantmix exclusively.
2. Examination of splitters should be done periodically. If the pans are excessively dented and misshaped, replacement should be considered.
3. If the chutes on a riffle splitter are excessively deformed, replacement should be considered.
4. Splitting operations should be conducted outside. Hearing protection, eye protection, dust masks and gloves are provided and are highly recommended to be used during the splitting operation – it is your responsibility to use them and replace them when needed.

5. Proper lifting methods are important to be used when splitting samples – it is your responsibility to use them.

REPORT

Record the wet weight of the reduced material obtained from this test method on the appropriate NDOT form that is associated to that specific test.



Figure 1
Adjustable Riffle Splitter



Figure 2
Riffle Splitter



Figure 3
Mini Riffle Splitter

State of Nevada
Department of Transportation
Materials Division

METHOD OF TEST FOR WASHING AND SIEVE ANALYSIS OF COARSE AND FINE AGGREGATE

SCOPE

This test method covers the procedure used to accurately determine the particle size distribution of coarse and fine aggregate samples; including Base Aggregates, Aggregates for Bituminous Courses, Concrete Aggregates, and other selected materials. As used herein, the term "Coarse Aggregate" refers to material retained on the 4.75 mm (No. 4) sieve, and the term "Fine Aggregate" refers to material passing the 4.75 mm (No. 4) sieve.

APPARATUS

1. Balance, with a capacity of 12,000 g and sensitive to 0.1 g.
2. Sieves, testing sieves shall be of the woven-wire type with square openings, and shall be certified annually (Figure 1).
3. Mechanical Sieve shaker (Figure 2, 3 and 4), any mechanical sieve shaker may be used which produces the thoroughness of Hand Sieving, "SIEVE TEST PROCEDURE".
4. Oven, capable of maintaining a temperature of $110 \pm 5^{\circ}\text{C}$ ($230 \pm 9^{\circ}\text{F}$).
5. Washing vessel, pans or containers of a size sufficient to contain the sample covered with water and to permit vigorous agitation without loss of any material.
6. Miscellaneous Tools, hand tools such as: Spoon, Stiff Bristle Brush, Trowel, Steel Wire Brush, Brass Wire Brush, Paint Brush (Figure 1).

SAMPLE PREPARATION

1. Obtain a representative sample per Test Method Nev. T200. Reduce the sample per Test Method Nev. T203. Weigh and record the sample as "Wet Weight" to the nearest 1 g.

Samples shall weigh, after drying, not less than the amount indicated in Table 1. The selection of samples of an exact predetermined weight shall not be attempted.

2. Dry the sample per Test Method Nev. T112.
3. Weigh and record the dried and cooled sample as "Dry Weight" to the nearest 1 g.

TABLE 1

Test Sample Size

Aggregate Size ¹	Minimum Dry Sample Weight ²
100 mm (4 in.)	At the discretion of the Engineer
90 mm (3 1/2 in.)	30,000 g
75 mm (3 in.)	25,000 g
63 mm (2 1/2 in.)	20,000 g
50 mm (2 in.)	15,000 g
37.5 mm (1 1/2 in.)	9,000 g
25 mm (1 in.)	3,000 g
19 mm (3/4 in.)	2,500 g
12.5 mm (1/2 in.)	1,500 g
9.5 mm (3/8 in.)	1,000 g
4.75 mm (No. 4)	500 g
2.36 mm (No. 8)	250 g

¹For purposes of this test method, "Aggregate Size" is defined to be the smallest sieve which will pass at least 90 percent of the sample, also referred to as the Nominal Maximum Size.

²Samples weighing 3,000 g or more shall be sieved through 40.640 x 10⁻² m (16 in.) or larger diameter sieves, to reduce the sample aggregate down to a size that can be tested with 304.8 mm (12 in.) or 203.2 mm (8 in.) diameter sieves. If this procedure is used, a combined sieve determination is made refer to "CALCULATIONS". The testing sieve frames may be square, round or rectangular, provided that not less than 1290.2 x 10⁻² m (508 in.) of sieving area is exposed.

WASH PROCEDURE

1. Perform the wash procedure on all samples except as follows:

Samples containing large portions of plus 25 mm (1 in.) aggregate may first be dry sieved over the required specification coarse aggregate sieve sizes down to the 25 mm (1 in.) or 19 mm (3/4 in.) sieve. The portion passing the 25 mm (1 in.) or 19 mm (3/4 in.) sieve is then split down to a representative sample of the required size (Table 1) and the wash test performed on this smaller sample.

In case of dispute, the wash test shall be performed on the entire sample prior to making the sieve test.

2. Place the dried and weighed sample into a washing vessel or vessels and cover with water. If desired, a small amount of wetting agent (liquid soap) may be added to assure a thorough separation of the finer aggregate particles from the coarser particles.

3. Agitate the contents of the washing vessel vigorously and immediately pour the wash water over a nest of two sieves consisting of a 2.36 mm (No. 8) or 1.18 mm (No. 16) sieve on top and a 75 μm (No. 200) sieve.

The agitation should be sufficiently vigorous enough to result in the complete separation from the coarse particles of all finer particles than the 75 μm (No. 200) sieve and bring the fine material into suspension, so that it will be removed by decantation of the wash water. Care shall be taken to avoid, as much as possible, the decantation of the coarse particles of the sample.

In order to remove all coatings and disperse all lumps, it may sometimes be necessary to scrub individual aggregate particles with a stiff fiber brush, and to rub soil lumps against sides and bottom of the washing vessel. The use of a spoon, rod or hand may be needed to stir and agitate the aggregate in the washing vessel.

Repeat the agitation/decantation procedure until the wash water is clear.

4. Wash the fine material retained on the 75 μm (No. 200) sieve with a gentle stream of running water. Check the cleanness of the soil retained on the 75 μm (No. 200) sieve by rubbing small amounts between the thumb and fingers. **DO NOT RUB THE SOIL OVER THE SURFACE OF THE 75 μm (No. 200) SIEVE.** Continue washing until the water running through the 75 μm (No. 200) sieve is clear.
4. Rinse the material retained on the nested sieves, plus the material remaining in the washing vessel, into a wide shallow pan. Decant the excess surface water back over the 75 μm (No. 200) sieve, taking care not to pour any portion of the sample out of the pan. If material is decanted onto the 75 μm (No. 200) sieve, repeat procedure. Dry the washed sample per Test Method Nev. T112.
6. Weigh and record the dried and cooled sample as "Wash Weight" to the nearest 1 g.

SIEVE PROCEDURE

1. Obtain the proper sieve specifications from the Standard Specifications for Road and Bridge Construction and/or Special Provisions for each type of material to be tested. Place the sieves into the proper descending order in a complete sieve stack.
 - a. Visually examine sieves each day for broken wires, stretched screens and/or broken solder around the perimeters. Remove and replace any damaged sieves, send the damaged sieves to Headquarters Construction - Quality Assurance Section for disposal.
 - b. Never sieve hot samples, hot aggregate will distort the fine meshes of the 150 μm (No. 100) and 75 μm (No. 200) sieves.
 - c. Always insert a full sieve deck into the shaker so that the shaker does not get damaged.
 - d. Take care to avoid loss of material throughout the entire testing process.

- e. Never allow any sieve to come into direct contact with a hot drying device.
2. When sieving coarse aggregate without prior washing, brush the larger aggregate particles with a stiff bristle brush to remove coatings, and break up soil lumps, taking care not to lose the fine particles thus obtained.
3. Sieving No. 4 coarse concrete aggregate: Aggregates shall be reduced per Test Method Nev. T203, dried per Test Method Nev. T112 and then sieved through the required specification sieves utilizing a shaker with large rectangular sieve trays (large test master shaker). Material remaining in the pan shall be fine-graded with the conventional 304.8 mm (12 in.) or 203.2 mm (8 in.) sieves to determine the “% Pass” the 75 μm (No. 200) sieve.
4. Place the cool dried weighed sample from the wash procedure, or the cool dried weighed sample of material without the washing into the appropriate sieve stack and place the sieve stacker into the sieve shaker.
5. Use one of the following methods for shaking:
 - a. Hand Sieving – Perform the hand method of sieving by means of a lateral and vertical shaking of the sieve, accompanied by a jarring action on a counter top to keep the sample moving continuously over the surface of the sieve. In no case shall fragments in the sample be forced through the sieve by your hand or fingers. Sieving shall be continued until not more than one percent by weight of the residue passes any sieve during the one minute of continuous shaking. For coarse aggregate, the thoroughness of sieving shall be determined with a single layer of material on the sieve.
 - b. Mechanical Sieving – Perform mechanical sieving on a mechanical shaker which gives the same type of shaking action described in (a.) "Hand Sieving". Shaking time is five minutes for coarse aggregate samples (in the large test master shaker) and ten minutes for combined (coarse and fine) or fine aggregate samples (in the Mary–Ann rotary shakers, the 12” sieve shaker or the 8” sieve shaker). Sieving time and thoroughness of mechanical sieving shall be verified periodically by the above described hand sieving method.
6. In no case shall the sieves be overloaded, see Table 2 to verify the maximum allowable quantity of material retained on each individual sieve. If the amount of material retained on any one sieve needs to be reduced, insert an additional sieve also known as a “buffer sieve” with openings slightly larger than the openings on the overloaded sieve, or split the entire sample into smaller portions, prior to sieving, and then combine respective fractions after sieving.

Table 2

Maximum Allowable Quantity of Material Retained on a Sieve, g

Sieve Opening Size	Nominal Dimensions of Sieve	
	203.2 mm (8 in.)	304.8 mm (12 in.)
75 mm (3 in.)	-	12600
63 mm (2 1/2 in.)	-	10600
50 mm (2 in.)	3600	8400
37.5 mm (1 1/2 in.)	2700	6300
25.0 (1 in.)	1800	4200
19.0 mm (3/4 in.)	1400	3200
12.5 mm (1/2 in.)	890	2100
9.5 mm (3/8 in.)	670	1600
4.75 mm (No. 4)	330	800
All sieves with openings smaller than 4.75 (No. 4)	200	450

7. Proper care of the sieves is necessary for accurate sieve results. Use the following procedure in removing particles stuck in each one of the sieves:
 - a. 2.36 mm (No. 8) sieves and larger: Clean by rounded piece of wood, such as a brush handle or a pointed trowel.
 - b. 2.00mm (No. 10) and 1.18 mm (No. 16) sieves: Clean by brushing with a steel wire brush.
 - c. 600 μm (No. 30), 425 μm (No. 40), and 300 μm (No. 50) sieves: Clean by brushing with a stiff short bristle brass wire brush.
 - d. 150 μm (No. 100) and 75 μm (No. 200) sieves: Clean only by brushing with a small paint brush. These sieves are easily damaged.

Do not distort any sieve openings with any of the tools mentioned above.

8. After sieving, weigh the material (on the same balance used to weigh the total sample prior to sieving), retained on each sieve and the pan. Record these weights to the nearest 1g as "Weight Ret." on the worksheet. The weight of minus 75 μm (No. 200) sieve material "Wash" removed from the sample by washing is found by subtracting the "Wash Weight" from the "Dry Weight" of the test sample prior to washing.

The sum of these weights must check with the dry weight within 3 g for combined (coarse and fine) and fine aggregate samples and within 10 g for coarse aggregate samples. If the sum of these weights are within the above stated tolerances, but do not check with the dry weight of the sample before

washing, adjust the sieve with the greatest weight retained to match the samples dry weight.

If the sum of these weights is outside the above stated tolerances, verification of weights shall be completed by re-weighing sample to verify dry weight after wash and/or by re-sieving the sample to verify weights retained on each sieve. If verification confirms an error outside of tolerances, then the test is considered invalid, and another test shall be performed.

“Weight Ret.” in the pan after sieving should not exceed 1% of the samples original dry weight. If the “Weight Ret.” in the pan exceeds 1% of the samples dry weight, it indicates that the sample was not sufficiently washed and is considered invalid and another test shall be ran. All future tests shall be washed more thoroughly.

CALCULATIONS

1. Convert the “Weight Ret.” on the various sieves, pan and wash to “% Ret.” using the following formula:

$$P_r = \frac{W_r}{W_t} \times 100$$

Where:

P_r = % Ret.; on each sieve, pan and wash.

W_r = Weight Ret.; on each sieve, pan and wash.

W_t = Total weight of dry sample prior to washing and sieving.

Make all calculations to the nearest 0.1 % and record these percentages as "% Ret." on the worksheet. The sum of the percentages retained on all sieves, pan and wash must equal 100.0%. If the sum does not equal 100.0%, then adjust the greatest percentage retained to equal 100.0%. In cases where the sum error is greater than 0.3%, re-check calculations. If the sum error is still outside the 0.3%, then the test is considered invalid, and another test shall be performed.

2. Calculate the “% Pass” for each sieve by one of the following methods:

Method 1: Place the “% Ret.” for the wash in the "% Pass" column for the pan. Add the “% Pass” the pan to the “% Ret.) on the 75 µm (No. 200) sieve to give the % Pass” on the next larger sieve. Continue in this manner for each sieve until the largest size is reached, at which time the “% Pass” should be 100.0%.

Method 2: Starting with the largest sieve size used, subtract the “% Ret.” on that sieve from 100% to give the total “% Pass” on the next smaller sieve. Then subtract the “% Ret.” on the next smaller sieve from the figure just obtained to give the total “% Pass” the third sieve. Continue in this manner until the pan and wash is reached, at which time the “% Pass” should be 0.0%.

Note: If 100.0% or 0.0% is not obtained in the “% Pass” column, then there is an error in the “Weight Ret.” or “% Ret.” columns that needs to be fixed.

3. If a coarse aggregate sample has been separated into two sizes for testing, compute the combined grading as follows:
 - a. Compute the individual grading of each size separately following the procedures outlined in the “CALCULATIONS” section paragraphs 1 and 2. This will give the “% Pass” for each sieve in both the coarse and fine portions of the sample.
 - b. Compute the percentage represented by the coarse and fine sizes, based on the total weight of the sample.

Example:

<u>Fraction</u>	<u>Size</u>		<u>Weight</u>	
	<u>Pass</u>	<u>Retained</u>	<u>Kilograms (lb)</u>	<u>Percentage</u>
Coarse	75 mm (3 in.)	25 mm (1 in.)	9.25 kg (20.4 lb)	49.5
Fine	25 mm (1 in.)	Pan	9.44 kg (20.8 lb)	50.5
Total			18.69 kg (41.2 lb)	100.0

- c. Taking the coarse and fine sizes separately, multiply the percentage of that size by the “% Pass” on each sieve.
- d. Add the products thus obtained on corresponding sieves. These sums constitute the overall grading on the combined sample.
- e. Refer to the Standard Operating Procedures (SOP Manual) for an example worksheet regarding the above calculations.

REPORT

Record test results on NDOT form 040–013 or 040–050.

Report the total “% Pass” for each sieve on the appropriate NDOT form, to the nearest 0.1% on the appropriate sieve sheet and reported to the nearest whole number on the appropriate coversheet. Passing or failing percentages will be based on the coversheet results. All failures shall be circled in red.

On NDOT form 040–035 the fine aggregate shall be reported to 0.1%, so that an accurate fineness modulus may be calculated.

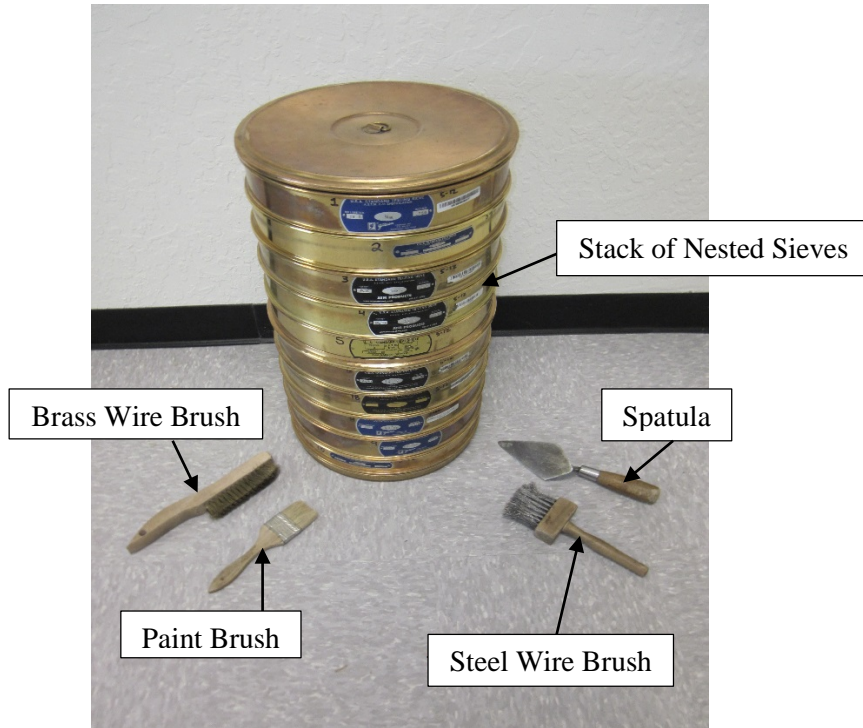

Figure 1



Figure 2

Mary-Ann Rotary – Mechanical Shaker



Figure 3
12" Gilson – Mechanical Shaker



Figure 4
Large Test Master – Mechanical Shaker

State of Nevada
Department of Transportation
Materials Division

METHOD OF TEST FOR DETERMINING THE LIQUID LIMIT OF SOIL

SCOPE

The liquid limit of a soil is that water content, as determined in accordance with the following procedure, at which the soil passes from a plastic state to a liquid state.

APPARATUS

1. Porcelain mixing bowl or similar non-absorbent mixing bowl (Figure 4), approximately 115 mm to 150 mm (4.5 in. to 6 in.) in diameter.
2. Spatula or pill knife (Figure 4), having a blade approximately 75 mm to 100 mm (3 in. to 4 in.) in length and 13 mm to 20 mm ($\frac{1}{2}$ in. to $\frac{3}{4}$ in.) in width.
3. Liquid limit device, manual or mechanical.

Manually operated device: a device consisting of a brass dish and carriage, constructed to the plan and dimensions shown in Figure 1. If a manually operated device is used, it shall be noted on NDOT form 040-014 the worksheet.

Mechanically operated device: a motorized device equipped to produce the rise and rate of shocks to a brass dish, constructed to the plan and dimensions shown in Figure 1.

4. Curved grooving tool, conforming to the critical dimensions shown in Figure 1. The use of a flat grooving tool shall not be permitted in this test procedure.
5. Gage, attached to the grooving tool (Figure 4), shall conform to the critical dimension "d" shown in Figure 1 of this method. If separate, the gage may be a metal bar 10.0 mm \pm 0.2 mm (0.394 in. \pm 0.008 in.) thick and approximately 50 mm (2 in.) long.
6. Glass beaker (Figure 4), 600 mL or other suitable microwave safe container.
7. Watch glass (Figure 4), approximately 75 mm (3.0 in.) in diameter.

8. Two Balances, one having 500 g minimum capacity, accurate to $\pm .01$ g (Figure 4) and the other balance having a 12,000 g capacity and sensitive to 0.1 g.
9. Oven, capable of maintaining a temperature of $110 \pm 5^\circ$ C ($230 \pm 9^\circ$ F).
10. Microwave Oven
11. Sieves (Figure 5), woven wire cloth sieves with 2.00 mm (No. 10), 425 μ m (No. 40) sieves with square openings, pan and lid.
12. Pulverizing apparatus, a mechanical pulverizing apparatus (MPA) (Figure 6) consisting of a power driven covered muller, a timer and a revolving drum into which the two rubber covered rollers and the soil sample are placed or a metal mortar and rubber-covered pestle (Figure 7).
13. Syringe (Figure 4), reading from 1 to 50 ml.

CALIBRATION OF LIQUID LIMIT DEVICE

1. The manual or mechanical liquid limit device shall be inspected for the following: the pin connecting the cup is not worn sufficiently to permit side play; the screws connecting the cup to the hanger arm are tight; the points of contact on the cup and base are not excessively worn; the lip of the cup is not excessively worn; and a groove has not been worn in the cup through long usage. The grooving tool shall be inspected to determine that the critical dimensions are followed as shown in Figure 1.

Wear is considered excessive when the point of contact on the cup or base exceeds 13 mm ($\frac{1}{2}$ in.) in diameter, or when any point on the rim of the cup is worn to approximately half of the original thickness. Although a slight groove in the center of the cup is noticeable, it is not objectionable. If the groove becomes pronounced before other signs of wear appear, the cup should be considered excessively worn. Excessively worn cups shall be replaced. A base that is excessively worn may be refinished as long as the thickness does not exceed the tolerance shown in Figure 1 by more than -2.5 mm (-0.1 in.) and the distance between the cup at the cam follower and the base is maintained within the tolerances specified in Figure 1.

2. Adjust the height of drop of the cup so that the point on the cup that comes in contact with the base rises to a height of 10.0 mm ± 0.2 mm (0.394 in. ± 0.008 in.). See Figure 2 for proper location of the gage relative to the cup during adjustment.

Adjusting the height of the drop is as follows: Place a piece of masking tape across the outside bottom of the cup parallel with the axis of the cup hanger pivot. The edge of the tape away from the cup hanger should bisect the spot on the cup that contacts the base. For new cups, place a piece of carbon paper on the base (or use a marking pen to mark the base where it contacts the cup) and allow

the cup to drop several times to mark the contact spot. Attach the cup to the device and turn the crank until the cup is raised to its maximum height. Slide the height gage under the cup from the front, and observe whether the gage contacts the cup or the tape, see Figure 2. If the tape and cup are both contacted, the height of drop is correct. If not, adjust the cup until simultaneous contact is made. Check adjustment by turning the crank at two revolutions per second while holding the gage in position against the tape and cup. If a slight ringing or clicking sound is heard without the cup rising from the gage, the adjustment is correct. If no ringing is heard or if the cup rises from the gage, readjust the height of the drop. If the cup rocks on the gage during this checking operation, the cam follower pivot is excessively worn and the worn parts should be replaced. Always remove the tape after completion of the adjustment operation.

SAMPLE PREPARATION

1. Obtain a representative sample per Test Method Nev. T200.
2. Obtain a representative sample in accordance with Test Method Nev. T203. Coarse material shall be $6250 \text{ g} \pm 250 \text{ g}$. Coarse material being defined as 10% or more of the stockpile retained on the 4.75 mm (No. 4) sieve. Fine material shall be $1250 \text{ g} \pm 250 \text{ g}$. Dry the representative sample at a temperature not to exceed 60°C (140°F) and record the dry weight under remarks on NDOT form 040–014 after drying is complete.

Coarse stockpiles will be processed using the Mechanical Pulverizing Apparatus (MPA).

Fine stockpiles will be processed using a mortar and rubber-covered pestle.

3. The aggregations of soil particles shall then be broken up in the pulverizing apparatus in such a way as to avoid reducing the natural size of individual particles with one of the following procedures:
 - a. Mechanical Pulverizing Apparatus (MPA) – tumbling: When using the MPA, place the two rubber covered rollers into the drum with the entire sample. Attach the lid and make sure the lid is sealed tightly. If a proper seal is not achieved the replacement of the lid, clamp or drum may be required. Place the drum on the machines rollers and start the MPA until approximately 420 revolutions (approximately 6 minutes) have been achieved.

NOTE: If the drum has to be rolled at a slower rate so that the drum stays on the rollers then additional revolutions may be needed – this should be determined during the annual equipment calibration.

PROCEDURE – METHOD A (THREE POINT METHOD)

1. When referee or dispute testing, the metal mortar and rubber-covered pestle will be used as the pulverizing apparatus. Referee or disputed tests shall be performed using distilled or demineralized water.
2. Use the $-425\ \mu\text{m}$ ($-$ No. 40) material obtained in the “SAMPLE PREPARATION”. Stir the $-425\ \mu\text{m}$ ($-$ No. 40) material until it is blended into a homogenous state. Spoon out a sample weighing $100\ \text{g} \pm 15\ \text{g}$ from the thoroughly mixed portion of the material into the porcelain mixing bowl. NOTE: If a minimum of 85 g are not obtained from the entire dried sample, the sample is to be reported as insufficient material on NDOT form 040–014 and no further testing is required.
3. Weigh and record all four (4) watch glass tare weights to the nearest 0.01 g, on NDOT form 040–014.
4. Place the $100 \pm 15\ \text{g}$ sample in the mixing bowl and thoroughly mix with 15 mL of water by alternately and repeatedly stirring and kneading with a spatula. Tap water may be used for routine testing if comparative tests indicate no differences in results between tap water and distilled or demineralized water. Use sufficient force in the kneading action to allow the moisture to come into contact with as many soil particles as possible. Further additions of water shall be made in increments of 1, 2 or 3 mL. Record the addition of all water increments on NDOT form 040–014 (this information may be used for comparison test results between testers). Add sufficient water to thoroughly coat and be absorbed into the soil sample uniformly. Each increment of water shall be thoroughly mixed with the soil, as previously described, before another increment is added. Once testing has begun, no additional dry soil shall be added to the moistened soil. The cup of the liquid limit device shall not be used for mixing soil and water. If too much moisture has been added to the sample, the sample shall either be mixed in the mixing bowl or kneaded until natural evaporation lowers the closure point to an acceptable range.

Some soils are slow to absorb water. It is possible to add increments of water so fast that a false liquid limit value is obtained. This can be avoided if more mixing time is allowed. Once the 25 – 35 shock range is achieved, the sample is then hydrated for 30 minutes ± 1 minute in the porcelain mixing bowl under a damp rag. After the sample has been hydrated, add 1 mL of water and mix for 1 minute.

5. A sufficient amount of the hydrated sample shall be placed in the bottom of the brass cup. Spread the sample with the spatula to where the sample level is trimmed to a depth of 10 mm (0.4 in.) at the point of maximum thickness. As few strokes as possible with the spatula shall be used, and care will be taken to prevent the entrapment of air bubbles within the mass.

Return the excess soil to the mixing dish and cover with a damp rag to retain the moisture in the sample. The soil in the brass cup of the device shall be divided by a stroke of the curved grooving tool along the diameter through the centerline of the brass cup so that a clean sharp groove of the proper dimensions will be formed as shown in Figure 3. To avoid tearing of the sides of the groove or slipping of the soil cake on the cup, use up to six strokes, with a stroke from front to back or back to

front counting as one stroke. Start the first stroke from front to back. The depth of the groove should be increased with each stroke and only the last stroke should scrape the bottom of the brass cup.

6. The brass cup containing the sample shall be lifted and dropped, mechanically or manually, at a rate of approximately two revolutions per second until the two sides of the sample come in contact at the bottom of the groove along a distance of about 13 mm (½ in.). The number of shocks required to close this groove distance shall be recorded on NDOT form 040-014 under on “No. of Blows”. If using the manual device, do not hold the base of the machine with the free hand, when turning the crank.

NOTE: If the sample slides on the surface of the cup instead of flowing, add 1 mL more of water to the sample, remix and retest. If the soil continues to slide on the cup at less than 25 blows, the test is not applicable and a note should be made in the remarks that the liquid limit could not be determined due to sliding in the brass cup and “N/A” should be written on NDOT form 040-014 under “L.L.”.

7. Once your initial blow range between the 25 and 35 shock range has been achieved, a slice of soil approximately the width of the spatula, extending across the soil cake perpendicular to the groove and including that portion of the groove in which the soil flowed together, shall be removed and placed on a pre-weighed watch glass. Weigh the watch glass and soil together and record this as the “Wet Weight” to the nearest 0.01 g on NDOT form 040-014. After removing the slice of material from the brass cup, the soil remaining in the brass cup shall be transferred back into the porcelain mixing bowl and covered with the damp rag. The brass cup and grooving tool shall then be washed and dried in preparation for the sample in the next shock range. After the 1st shock range is obtained remove an 8 g representative sample from the porcelain mixing bowl and place under watch glass #4 upside down until Test Method Nev. T211/T212 is ready to be performed.
8. Add 1, 2 or 3 mL of water at a time to the soil remaining in the porcelain mixing bowl until the next shock range is achieved. Thoroughly mix the water into the sample by alternately stirring and kneading with a spatula.
9. Steps # 5, # 6, # 7 and # 8 shall be repeated for at least two additional portions of the sample to which sufficient water has been added to bring the soil to a more fluid condition. The object of this procedure is to obtain samples of such consistency that at least one determination will be made in each of the following shock ranges: 25 – 35, 20 – 30, 15 – 25, and the range between the three determinations is at least 10 shocks between the first and third shock range. If there are not 10 shocks between the first and third shock range the test is considered invalid and another test shall be ran.
10. Dry all four of the samples using one of the methods in Test Method Nev. T112 or by the following microwave oven procedure: Place a 600 mL glass beaker or other suitable container filled with approximately 300 mL of water (maintain water level during drying) into the microwave oven to

prevent over heating during the drying process. Place all four of the watch glasses and soil into the microwave oven. Dry the sample for 5 minutes and change the water with fresh cool water.

Continue drying at 2 minute intervals until a constant weight is achieved. Drying times may be adjusted based on type and size of microwave oven. Weigh and record the dried and cool samples to the nearest 0.01 g as “Dry Weight” on NDOT form 040–014.

11. Report the “% of Moisture” to the nearest 0.1 percent on NDOT form 040–014.

REFEREE OR DISPUTE TESTING

Method A shall be used in making referee or dispute tests. The results of the liquid limit are influenced by: the time required to perform the test; the moisture content at which the test is begun; and the addition of dry soil to the hydrated sample (not allowed).

In making the liquid limit test for referee or dispute purposes, the following time schedule shall replace the time schedule used in “Method A” be used:

1. Mixing of soils with water: 5 to 10 minutes, the longer period being used for the more plastic soils.
2. Placing in the brass cup and testing: 3 minutes.
3. Adding water and remixing: 3 minutes.

No test requiring more than 35 blows or fewer than 15 blows shall be recorded.

PROCEDURE – METHOD B *(Single point method for the Materials Division Lab only)*

1. The material for the liquid limit test is to be obtained per “SAMPLE PREPARATION”.
2. A sample weighing about 50 g shall be taken from the thoroughly mixed portion of the material passing the 425 μm (No. 40) sieve that has been obtained in accordance with this test method.

NOTE: If 50 g are not obtained, the sample is to be reported as insufficient material and no further testing is required.

3. Use the test procedure from “Method A” except that the initial amount of water to be added will be 8 to 15 mL and the moisture sample taken shall be only for the one point.
4. Groove closures between 15 and 35 blows may be accepted if variations of ± 5 percent of the true liquid limit are tolerable.
5. Groove closures between 5 and 15 blows may be accepted when testing sand.

CALCULATION

The water content of the soil shall be expressed as the moisture content in percentage of the mass of the oven dried soil and shall be calculated as follows:

$$\text{Percentage of Moisture} = \frac{\text{mass of water}}{\text{mass of oven dried soil}} \times 100$$

Calculate the percentage of moisture to the nearest 0.1 percent on NDOT form 040–014.

PREPARATION OF FLOW CURVE

A Flow Curve representing the relations between moisture content and corresponding number of shocks shall be plotted on the graph provided on form NDOT 040–014. The % of moisture shall run across the bottom of the graph and the shocks shall be on the left of the graph. The flow curve shall be a straight line drawn as nearly as possible through the three plotted points. A computer method of best fit straight line regression analysis may be used to determine the liquid limit. If the three points do not form a straight line, connect the points with three lines, forming a triangle. The difference between the two lines that intersect with the 25 shock ordinate shall not be more than 0.3 percent moisture. If this criterion is not met, the test is considered invalid and another test shall be ran.

When a triangle is formed, take the difference between the two lines that intersect the 25 blow line and average that. Then take the averaged difference and add or subtract to a line dissecting the 25 blow line and this is your LL value. If the difference is outside of the 0.3 percent range, the test is invalid and another test shall be ran.

LIQUID LIMIT

The moisture content corresponding to the intersection of the flow curve with the 25 shock ordinate shall be taken as the liquid limit of the soil. Calculate the liquid limit to the nearest 0.1. This liquid limit value will be utilized for calculation of the plasticity index in Test Method Nev. T211/212. If unable to obtain a liquid limit after running the test in its entirety as described, NA will be recorded under LL and NP recorded under PL.

REPORT

Report the liquid limit to the nearest whole number on NDOT form 040–010. Report the liquid limit on NDOT form 040–014 to the 0.1.

PRECISION STATEMENT

This precision statement only applies to soils having a liquid limit range from 21 to 67.

1. Repeatability (single operator): Two results obtained by the same operator on the same sample in the same laboratory using the same equipment and on different days, should be considered suspect if they differ by more than 7 percent of their average.
2. Reproducibility (multi-laboratory): Two results obtained by different operators in different laboratories should be considered suspect if they differ from each other by more than 13 percent of their average.

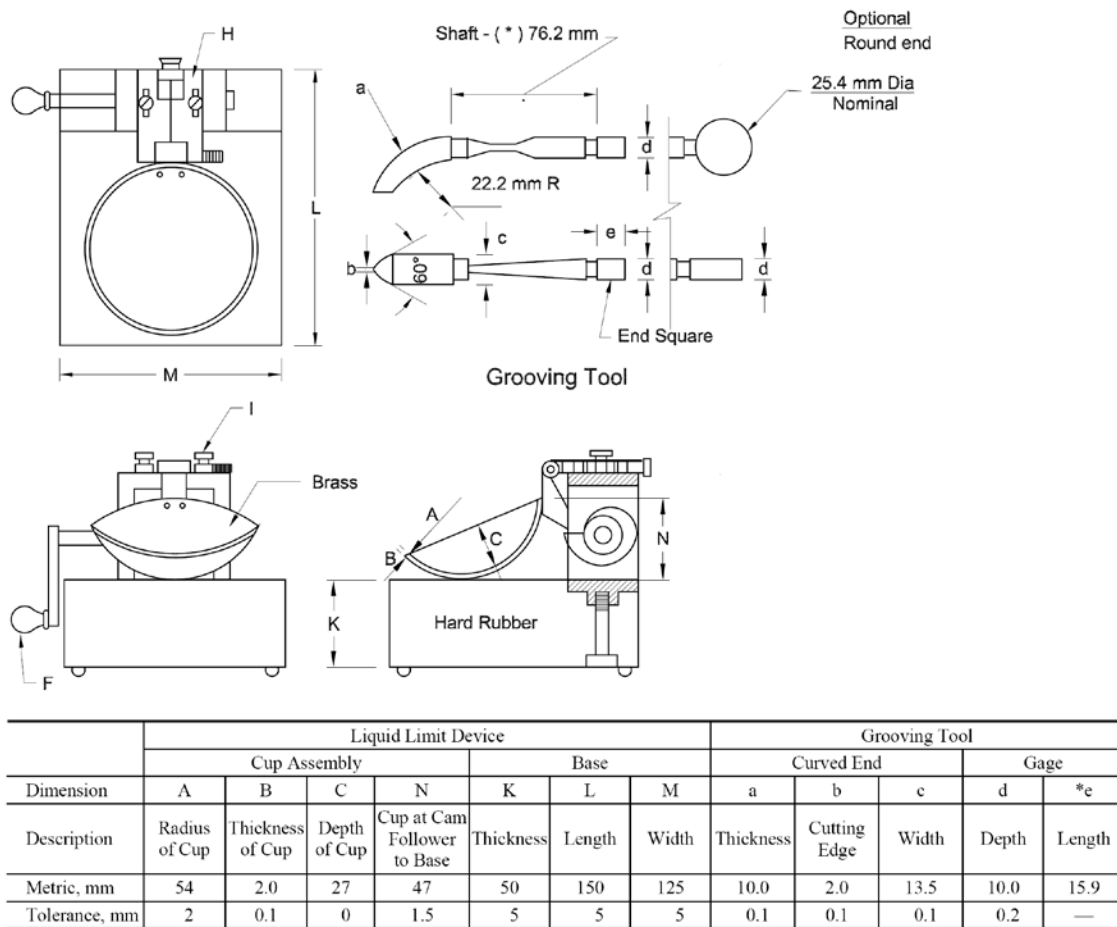

Note: Plate "H" may be designed for using (1) one securing screw (I).
An additional wear tolerance of 0.1 mm shall be allowed for dimension "b" for used grooving tools.
Feet for base shall be of resilient material.
(*) Nominal dimensions.
All tolerances specified are plus or minus (±) except as noted above.

Figure 1—Manual Liquid Limit Device

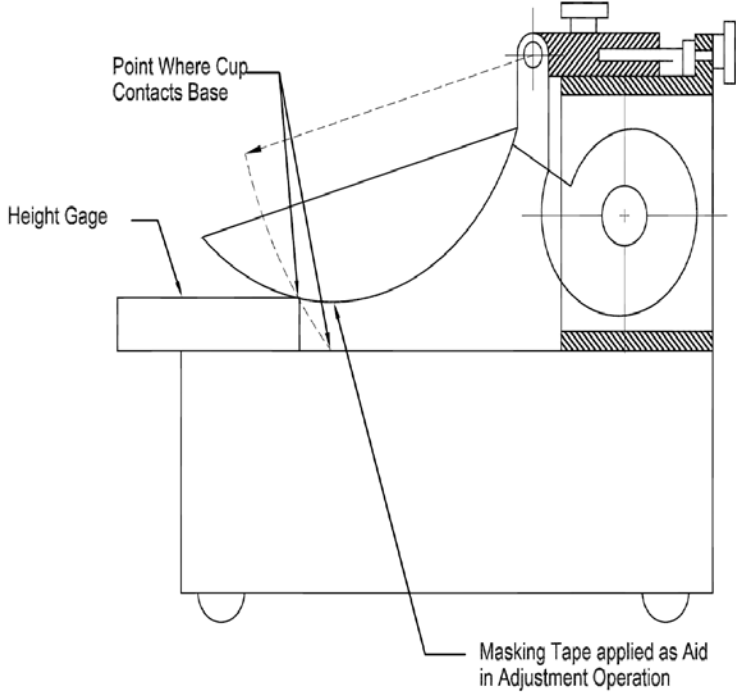

Figure 2—Calibration for Height of Drop

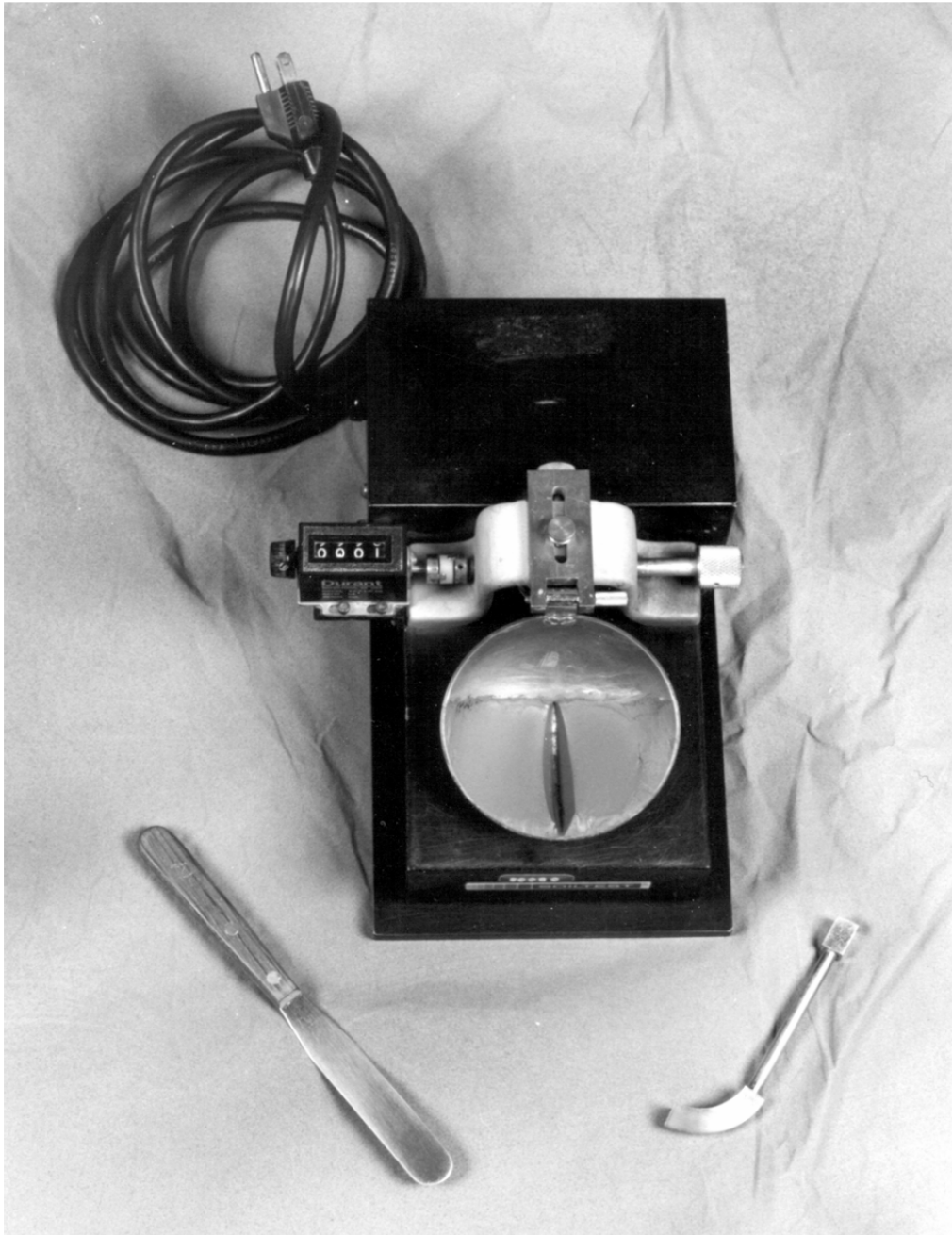

Figure 3—Liquid Limit Device with Soil Sample in Place

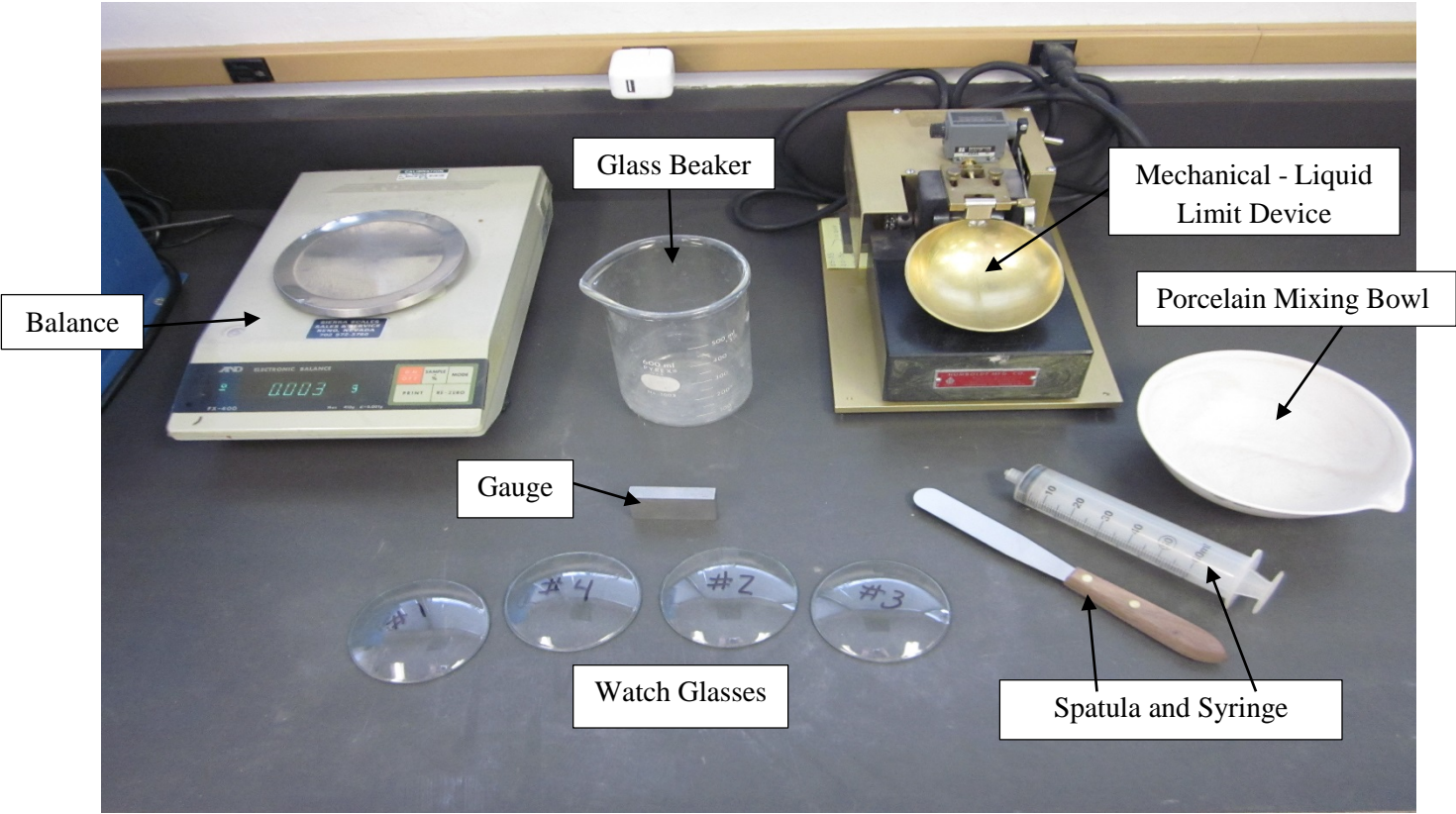

Figure 4



Figure 5
Stack of Nested Sieve



Figure 6
MPA with Revolving Drum



Figure 7
Metal Mortar and Rubber-Covered Pestle

State of Nevada
Department of Transportation
Materials Division

**METHOD OF TEST FOR DETERMINING THE PLASTIC LIMIT AND
PLASTICITY INDEX OF SOIL**

SCOPE

The plastic limit of a soil is the lowest water content determined in accordance with the following procedure at which the soil remains plastic. The plasticity index of a soil is the range in water content, expressed as a percentage of the mass of the oven dried soil, within which the material is in a plastic state. The plastic index value is the numerical difference between the liquid limit and the plastic limit of the soil.

APPARATUS

1. Ground glass plate (Figure 1), to roll the sample out.
2. Watch glass (Figure 1), approximately 75 mm (3.0 in.) in diameter.
3. Balance (Figure 1), having a 500 g minimum capacity, accurate to 0.01 g.

SAMPLE PREPARATION

Obtain a sample with a mass of 8 g from the thoroughly mixed and hydrated portion of the soil from the 1st shock range (35 – 25) while completing Test Method Nev. T210. Set the sample aside under watch glass # 4 on top of the ground glass plate to avoid loss of moisture until Test Method Nev. T210 has been completed.

PROCEDURE

1. Weigh the watch glass and record as “Tare Weight” on NDOT form 040–014, to the nearest 0.01 g.
2. Squeeze and form the 8 g sample into an ellipsoidal shaped mass. Divide the sample into 1.5 g to 2.0 g portions. Cover the remainder of the sample with a watch glass, to prevent moisture loss.
3. Place the ground glass plate on a smooth horizontal surface. Roll each portion into a 3 mm (1/8 in.) thread at a rate of 80 to 90 strokes per minute, counting a stroke as one complete motion of the hand forward and back to the starting position again. Roll the mass between the palm or fingers and the ground glass plate, with just sufficient pressure to roll the mass into a thread of uniform diameter throughout its length. The thread shall be further deformed on each stroke until its diameter reaches 3 mm (1/8 in.). The amount of hand or finger pressure required will vary greatly, according to the soil.

4. When the entire 8 g sample has been rolled into 3 mm (1/8 in.) threads, collect the 3mm (1/8 in) threads together and squeeze between the thumb and fingers of both hands into a uniform mass of an ellipsoidal in shape, divide the sample into 1.5 g to 2.0 g portions and reroll. Continue this alternate rolling into a thread 3 mm (1/8 in.) in diameter, gathering together, kneading and rerolling, until the thread crumbles under the pressure required for rolling and the soil can no longer be rolled into a thread. The crumbling may occur when the thread has a diameter greater than 3 mm (1/8 in.). This shall be considered a satisfactory end point, provided the mass has been previously rolled into a thread 3 mm (1/8 in.) in diameter and the entire sample crumbles.

The crumbling will manifest itself differently with the various types of soils. Some soils fall apart in numerous small aggregations of particles; others may form an outside tubular layer that starts splitting at both ends. The splitting progresses toward the middle, and finally, the thread falls apart in many small platy particles. Heavy clay soils require much pressure to deform the thread, particularly as they approach the plastic limit, and finally, the thread breaks into a series of barrel shaped segments each about 6 mm to 9 mm (1/4 in. to 3/8 in.) in length. At no time shall the operator attempt to produce failure at exactly 3 mm (1/8 in.) diameter by allowing the thread to reach 3 mm (1/8 in.), then reducing the rate of rolling or the hand pressure, or both, and continuing the rolling without further deformation until the thread falls apart. It is permissible, however, to reduce the total amount of deformation for feebly plastic soils by making the initial diameter of the ellipsoidal shaped mass nearer to the required 3 mm (1/8 in.) final diameter.

If the soil will not roll out to the required 3 mm (1/8 in.) diameter and sufficient moisture has been added, the plastic limit will be reported as N/A and the plasticity index will be reported as NP.

5. Repeat step #2, #3 and #4 above until the entire 8 g sample is completely tested.
6. Place the crumbled soil on watch glass # 4. Weigh and record the “Wet Weight” on NDOT form 040–014 to the nearest 0.01 g.
7. Dry the crumbled soil on watch glass # 4 with the other three watch glasses obtained during Test Method Nev. T210 per “PROCEDURE – METHOD A (THREE POINT METHOD)” step # 10.

CALCULATIONS

1. Calculate the plastic limit, expressed as the water content in percentage of the mass of the oven dry soil, as follows:

$$\text{Plastic Limit} = \frac{\text{mass of water}}{\text{mass of oven dry soil}} \times 100$$

Calculate the plastic limit to the nearest 0.1 g.

2. Calculate the plasticity index of a soil as the difference between its liquid limit and its plastic limit, as follows:

$$\text{Plasticity Index} = \text{Liquid Limit} - \text{Plastic Limit}$$

When the liquid limit or plastic limit cannot be determined, report the plasticity index as NP (non-plastic), on NDOT form 040-014, 040-013 and 040-010.

When the plastic limit is equal to, or greater than, the liquid limit, report the plasticity index as NP (non-plastic), on NDOT form 040-014, 040-013 and 040-010.

Calculate the plasticity index to the nearest 0.1 on NDOT form 040-014 and 040-013.

REPORT

Report the plasticity index to the nearest 0.1 on NDOT form 040-014 and 040-013. Report the plasticity index to the whole number on NDOT form 040-010.

PRECISION STATEMENT

This precision statement applies to soils with a plastic limit range between 15 and 36.

Repeatability (Single Operator): Two results obtained by the same operator on the same sample in the same laboratory using the same apparatus should be considered suspect if they differ by more than 10 percent of their average.

Reproducibility (Multilaboratory): Two results obtained by different operators in different laboratories should be considered suspect if they differ from each other by more than 18 percent of their average.

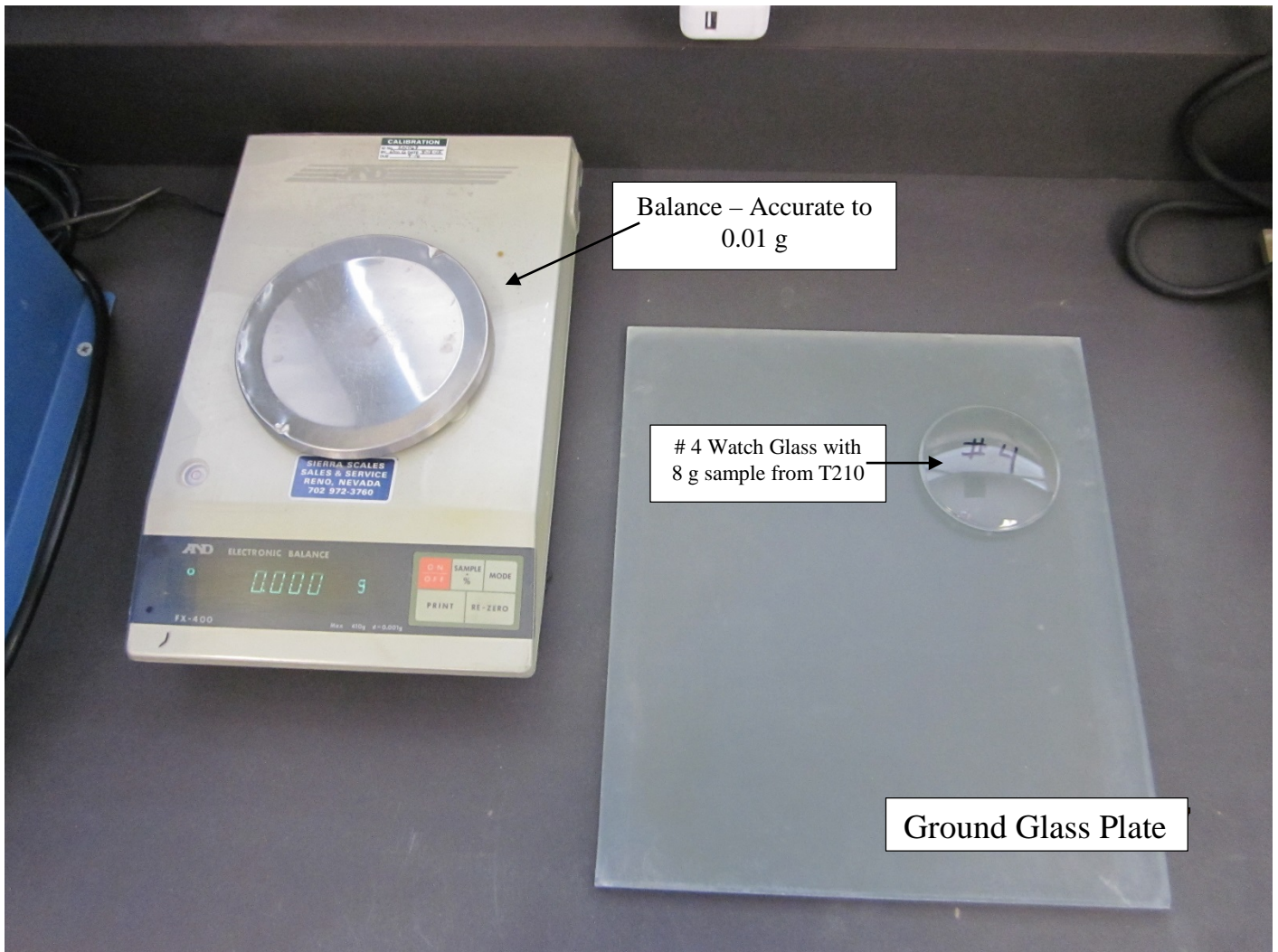

Figure 1

State of Nevada
Department of Transportation
Materials Division

METHOD OF TEST FOR SAND EQUIVALENT

SCOPE

This test method is intended to determine the proportion of detrimental fines (dust or claylike material) in the portion passing the 4.75 mm (No. 4) sieve of soils or graded aggregates.

APPARATUS

1. Sand Equivalent Apparatus (Figure 1), graduated plastic cylinders, rubber stopper, irrigator tube, weighted foot assembly and siphon assembly fitted to a glass 4 L (1 gal.) bottle placed on a shelf 915 ± 25 mm (36 in. \pm 1 in.) above the work surface.
2. Measure, tin measure having a capacity of 85 ± 5 mL (3 oz.) approximately 57 mm (2.25 in.) in diameter.
3. Balance, having a capacity of 12,000 g and sensitive to 0.1 g.
4. Funnel, wide-mouth funnel approximately 100 mm (4 in.) in diameter at the largest side of the funnel.
5. Stop watch, accurate to the nearest 0.1 seconds.

6. Shaker,

Mechanical Shaker (Figure 2) – with a throw of $203 \text{ mm} \pm 1 \text{ mm}$ (8 in. \pm 0.04 in.) and operating at 175 ± 2 cycles per minute.

Manual Shaker (Figure 3) – capable of producing an oscillating motion at the rate of 100 complete cycles in 45 ± 5 seconds, with a hand assisted half stroke length of $127 \text{ mm} \pm 5 \text{ mm}$ (5 in. \pm 0.2 in.) with a C-Clamp to latch to counter top.

7. Working Calcium Chloride Solution, produced by adding $85 \text{ mL} \pm 5 \text{ mL}$ of Stock Calcium Chloride Solution to 1 gallon of distilled or demineralized water. Stock Calcium Chloride Solution is obtained from the NDOT Materials Division. Dispose of Stock Calcium Chloride Solution that has been mixed with water when growth is present in the mixture.
8. Oven, capable of maintaining a temperature of $110 \pm 5^\circ\text{C}$ ($230 \pm 9^\circ\text{F}$)
9. Sieve, 4.75 mm (No. 4)
10. Mini riffle splitter, chute width – 3 mm (1/8 in.)

SAMPLING

1. Obtain a representative sample per Test Method Nev. T200.
2. Obtain a representative portion of the sample per Test Method Nev. T203.

SAMPLE PREPARATION

1. Thoroughly hand sieve the material over the 4.75 mm (No. 4) sieve. While sieving ensure that all the fines are cleaned from the material retained on the 4.75 mm (No. 4) sieve and included with the material passing the 4.75 mm (No. 4) sieve. Retain all the material passing the 4.75 mm (No. 4) sieve, the sample size should be approximately 500 g to 1000 g. Oven dry the sample at $60 \pm 3^{\circ}\text{C}$ ($140 \pm 5^{\circ}\text{F}$) or air dry sufficiently, until a complete separation of the coarse and fine material within the passing 4.75 mm (No. 4) sample can be achieved. , but not so dry as to lose portions of the fines while splitting the material through the mini riffle splitter (damp material).
2. Dampen the dried – 4.75 mm (– No. 4) material so the fines are not lost during the splitting process through the mini riffle splitter. Split the damp – 4.75 mm (– No. 4) material into four quarters, using the mini riffle splitter and fill each one of the four 85 mL (3 oz.) tins to within 0.48 mm (3/16 in.) of the brim, tapping the bottom of the tin on the counter to cause consolidation of the material and allowing the maximum amount to be placed in the tin without overflowing the tins. Striking off the tin measure level is not allowed. Adjustments are usually required to provide the desired test sample size. However, make these adjustments before the sample is reduced below a volume equal to four tin measures, or approximately 450 g for material of average specific gravity.

NOTE: Use extreme care in the sand equivalent test sample preparation to obtain a truly representative sample. Experiments show that as the amount of material being reduced by splitting or quartering is decreased, the accuracy of providing representative portions is decreased. For this reason, it is imperative that the sand equivalent test sample, which is already relatively small, be split carefully. When it appears necessary, dampen the material to avoid segregation or loss of fines.

3. After obtaining the four 85 mL (3 oz.) tins of material, dry the test samples in the tins, in an oven, to a constant mass at $60 \pm 3^{\circ}\text{C}$ ($140 \pm 5^{\circ}\text{F}$) and cool before testing.

PROCEDURE

1. Siphon $101.6 \text{ mm} \pm 2.5 \text{ mm}$ (4 in. \pm 0.1 in.) of working calcium chloride solution into each of the four graduated plastic cylinders.
2. Place the funnel on top of the graduated plastic cylinder and pour a tin of material into one of the graduated plastic cylinders. Cover the opening of the graduated plastic cylinder while tapping the bottom of the cylinder sharply on the heel of the hand several times to release any air bubbles and to promote thorough wetting of the sample.

3. Allow the saturated sample to stand undisturbed for 10 minutes \pm 1 minute. After the 10 minute time period, stopper the graduated plastic cylinder, loosen the sample from the bottom by partially inverting the cylinder and shaking it simultaneously.
4. After loosening the material from the bottom of the graduated plastic cylinder, shake the cylinder and contents by one of the following methods:

Mechanical Shaker Method (Figure 2) – The mechanical shaker shall be bolted to the counter or shelf it is on. Secure the stoppered graduated plastic cylinder in the mechanical shaker, allow the mechanical shaker to shake the sample for 45 seconds \pm 1 second.

Manual Shaker Method (Figure 3) – Secure the manual shaker to the counter with a C-Clamp. Secure the stoppered graduated plastic cylinder to the spring clamps on the manual shaker and reset the stroke counter to zero. Stand directly in front of the manual shaker, with the fingers of the right hand placed on the vertical steel strap, force the pointer towards the counter maintaining a smooth oscillating motion. Continue the shaking process for 100 strokes. Make sure the gradations are facing up so as not to render the marks illegible.

5. Once shaking is complete, remove the graduated plastic cylinder from the clamps and swirl as much of the material to the bottom of the graduated plastic cylinder as possible. Set the graduated plastic cylinder on the counter and remove the stopper.
6. Insert the irrigator tube into the graduated plastic cylinder, unclamp the irrigator tube and rinse any material left on the stopper and the walls of the graduated plastic cylinder as the irrigator is lowered. Force the irrigator tube through the sample to the bottom of the graduated plastic cylinder by applying a gentle stabbing and twisting action. This flushes the fines into suspension above the coarser particles. Continue the stabbing twisting action until the working solution reaches the 381 mm (15 in.) mark on the graduated plastic cylinder.
7. Let the graduated plastic cylinder stand undisturbed for 20 minutes \pm 15 seconds. Start the timer as soon as the irrigator tube has been removed from the graduated plastic cylinder.
8. At the end of the 20 minute sedimentation period, read the level of the top of the clay suspension. This is referred to as the clay reading. If no line of demarcation has formed at the end of the specified period, allow the sample to stand undisturbed until a clay reading can be obtained or for a maximum of 30 minutes. If the total sedimentation time exceeds 30 minutes, rerun the test with one of the other four samples of the same material.
9. Gently place the weighted foot assembly into the graduated plastic cylinder and keep the sand reading indicator in contact with the graduated plastic cylinder wall as it is lowered towards the sand. Once the weighted foot comes to rest on the sand; make sure the sand reading indicator is in contact with the graduated plastic cylinder wall and read the level of the sand reading indicator. Subtract 254 mm (10 in.) from the sand reading (Ex. 13.5 – 10 = 3.5). This is referred to as the sand reading.

NOTE: If the clay or sand reading falls between two graduations on the graduated plastic cylinder, record the higher graduation as the reading. For example, a clay reading of 3.75 would be recorded at 3.8 and a sand reading of 3.22 would be recorded as 3.3.

10. Steps 1 through 9 shall be repeated for all four tin samples. Use the three individual SE values that are the closest together, to calculate the S.E. value. Each of the three sand equivalent values must be within ± 4 points from the average of these values. If this tolerance is not met, re-run the test using material retained from the original sample.

CALCULATIONS

1. Calculate the sand equivalent (S.E.) to the nearest 0.1 using the following formula and report that number to the next whole number:

$$(\text{Sand Reading} / \text{Clay Reading}) \times 100 = \text{S.E.}$$

$$(\text{EX. } (3.3 / 3.5) \times 100 = 94.3 = 95)$$

2. Average the 3 sand equivalent whole values:

$$\text{S.E.} + \text{S.E.} + \text{S.E.} = \text{Total} / 3 = \text{S.E. average}$$

$$(\text{EX. } 95 + 94 + 93 = 282 / 3 = 94)$$

REPORT

Report the average Sand Equivalent (S.E.) to the nearest whole number on NDOT form 040-006.

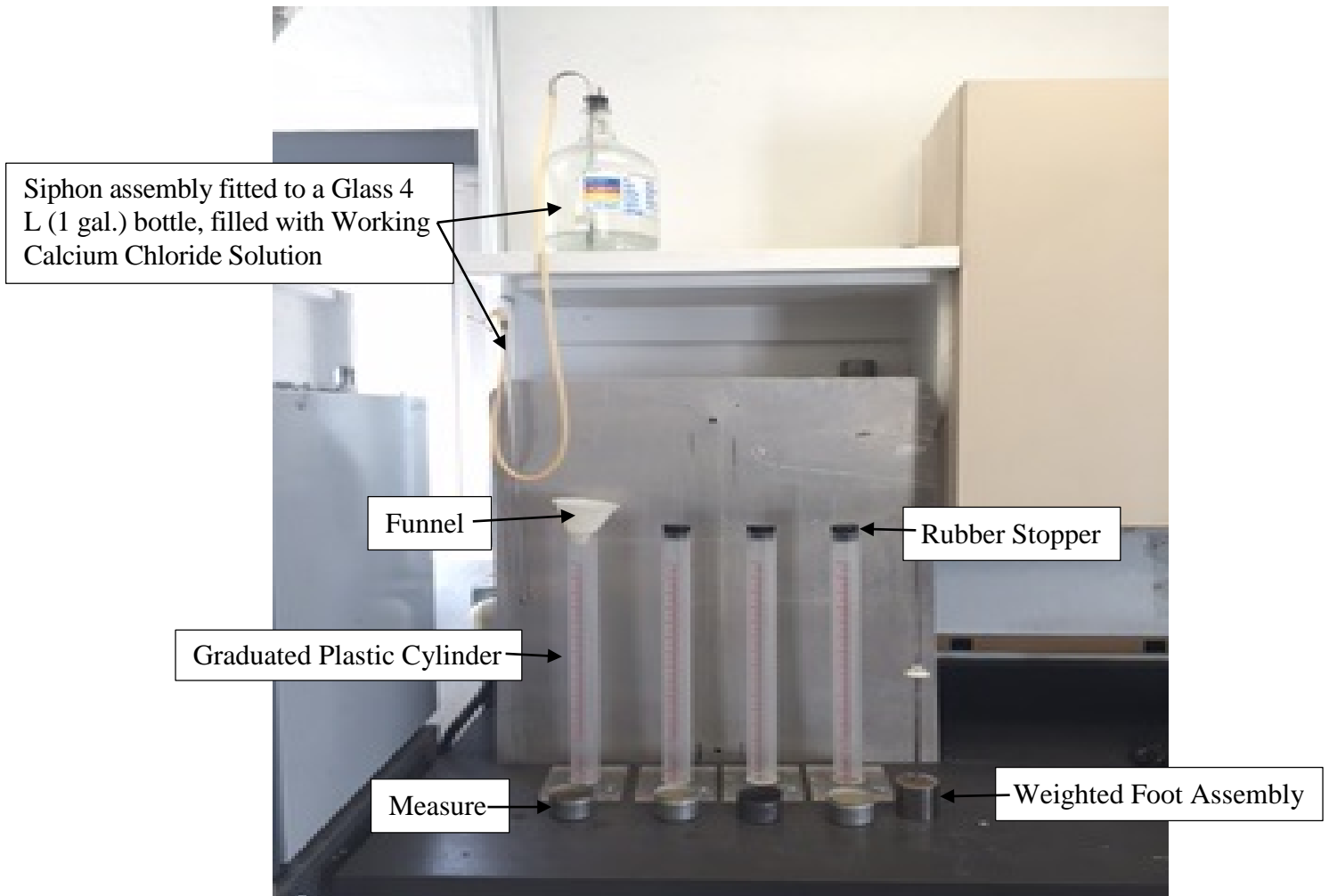

Figure 1

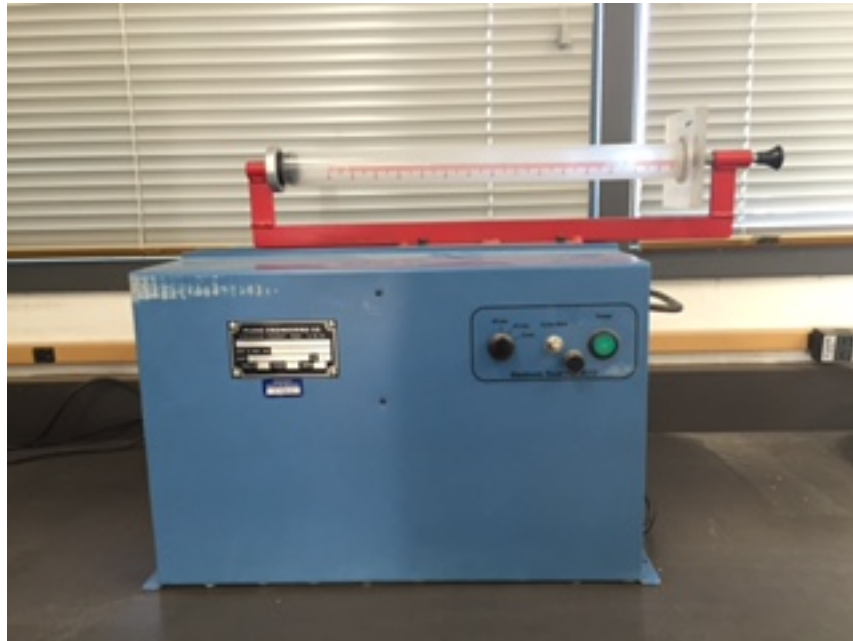

Figure 2
Mechanical – SE Shaker



Figure 3
Manual – SE Shaker

**State of Nevada
Department of Transportation
Materials Division**

METHOD OF TEST FOR EVALUATING CLEANNESS OF COARSE AGGREGATE

SCOPE

The cleanness test provides an indication of the relative proportions of clay-sized material clinging to coarse aggregates or screenings.

APPARATUS

1. Agitator (Figure 2), mechanical device designed to hold the wash vessel in an upright position while subjecting it to a lateral reciprocating motion at a rate of 285 ± 10 complete cycles per minute.
2. Wash vessel (Figure 2), flat-bottom, straight sided, cylindrical vessel with a capacity of 7.5L.
3. Collection pot (Figure 1), round pan or container with vertical sides and equipped to hold the wire mesh of a standard 203 mm (8.0 in) diameter sieve at least 76 mm (3.0 in) above the bottom.
4. Graduated plastic beaker (Figure 1), with a capacity of 1000 mL to 1500 mL.
5. Graduated plastic cylinder (Figure 1), sand equivalent test cylinder with a rubber stopper.
6. Funnel (Figure 1), wide-mouthed funnel suitable for directing water into the graduated plastic cylinder.
7. Sieves (Figure 1), 2.36 mm (No. 8) and 75 μ m (No. 200), standard 203 mm (8 in) diameter, full height.
8. Rocker and box assembly (Figure 3 and 4), 4.75 mm (No. 4) and 25.0 mm (1 in). (See Figure 4 and Figure 5)
9. Balance, with a capacity of 12,000 g and sensitive to 0.19.
10. Oven, capable of maintaining a temperature of $110 \pm 5^{\circ}\text{C}$ ($230 \pm 9^{\circ}\text{F}$).
11. Stop watch, in minutes and seconds
12. Brass or steel wire brush.
13. Stock calcium chloride solution. (Obtain from Materials Division – Chemistry Lab)

SAMPLE PREPARATION

1. Obtain a representative sample per Test Method Nev. T200
2. Reduce the sample per Test Method Nev. T203. Obtain the proper amount of aggregate and wash water per Table 1.

TABLE 1

PRIMARY AGGREGATE NOMINAL SIZE	OVEN-DRY MASS (g)	VOLUME OF WASH WATER (mL)
63mm x 37.5mm (2 ½ in x 1 ½ in)	20000 ± 1000	1500 ± 15
37.5mm x 19.0mm (1 ½ in x ¾ in) #4	10000 ± 500	1250 ± 12
25 mm x 4.75 mm (1 in x No. 4) #57 & #67	2500 ± 125	1000 ± 5
12.5 mm Max. (½" Max.) CHIPS	1000 ± 50	500 ± 3

3. Dry sample to a constant weight at 110 ± 5°C (230 ± 9°F).
4. Cool sample to room temperature.
5. Complete the sample preparation according to the **primary aggregate nominal size**.

63 mm x 37.5 mm (2 ½ in x 1 ½ in) AND 37.5 mm x 19.0 mm (1 ½ in x ¾ in) (No. 4 aggregate)

- a. Divide the sample into portions weighting approximately 2500g each.
- b. Place one of the portions on the rocker box assembly and sieve and “rock” the material on the 4.75 mm (No. 4) rocker box assembly and sieve 10 cycles in 12 seconds. One complete cycle is a back and forth motion with the stops on each end of the rocker box assembly and sieve bumping the floor before the motion is reversed.
- c. Repeat for each divided portion.
- d. Discard material that passes the 4.75 mm (No. 4) sieve.
- e. Save the material retained 4.75 mm (No. 4) for the test.
- f. Retain each of the four portions in separate containers.

25 mm x 4.75 mm (1 in. x No. 4) (#67 & #57 aggregate)

No further preparation is required.

Pit-Run Aggregate

- a. Divide the sample into portions weighting approximately 2500g each.
- b. Place one of the portions on the rocker box assembly and sieve and “rock” the material on the 4.75 mm (No. 4) rocker box assembly and sieve 10 cycles in 12 seconds. One complete cycle is a back and forth motion with the stops on each end of the rocker box assembly and sieve bumping the floor before the motion is reversed.
- c. Repeat for each divided portion.
- d. Discard material that passes the 4.75 mm (No. 4) sieve.
- e. Save the material retained 4.75 mm (No. 4) for the test.
- f. Split or quarter out a test specimen conforming to the mass requirements for **25 mm x 4.75 mm (1 in. x No. 4)** aggregate on Table 1.

12.5 mm (½ in. Max.) maximum size aggregates (Screenings/Chips)

No further preparation is required.

PROCEDURE

1. Measure out the appropriate volume of water for the test specimen according to Table 1.
2. Wash the prepared test specimen according to the appropriate procedure below:

63 mm x 37.5 mm (2 ½ in. x 1 ½ in.)

- a. Pour the wash water into the washing pan.
- b. Submerge each aggregate particle individually in the wash water and remove the fines by scrubbing with a stiff fiber brush.
- c. Discard the washed particle and repeat the procedure until all particles have been washed. Take care to avoid loss of wash water or fines.
- d. Stir the wash water vigorously to bring the fines into suspension and pour the dirty wash water and accumulated fines through the 75 µm (No. 200) sieve into the collection pot.
- e. Use a small amount of fresh water to rinse any remaining fines from the washing pan.

- f. Pour the wash water into a graduated plastic beaker and adjust the volume to 1500 ± 10 mL with fresh water. Return the wash water to the collection pot taking care to include all water and fines.

37.5 mm x 19.0 mm (1 ½ in. x ¾ in.) (No. 4 aggregate)

- a. Place one of the 2500 g portions in the wash vessel.
- b. Add the measured amount of wash water, clamp the lid in place, and secure the wash vessel in the agitator and let it sit for $1 \text{ min} \pm 10 \text{ s}$.
- c. Start the agitator and agitate the wash vessel for a period of $1 \text{ minute} \pm 10 \text{ s}$.
- d. Immediately following the agitation period, take the vessel from the agitator, and remove the lid.
- e. Bring the fines into suspension by holding the vessel in an upright position and moving it vigorously in a horizontal circular motion 5 or 6 times to cause the contents to swirl inside.
- f. Immediately pour all of the contents of the vessel into the 2.36 mm (No. 8) and $75 \mu\text{m}$ (No. 200) sieves nested over the collection pot.
- g. Discard the material retained on the 2.36 mm (No. 8) sieve.
- h. Pour the wash water from the collection pot into a graduated plastic beaker, and adjust the volume to 1250 ± 10 mL with fresh water.
- i. Place the second portion of the test specimen in the washing vessel, add the same wash water, and wash according to the above procedures.
- j. Repeat this procedure with each of the four portions of the test specimen.
- k. After washing the last portion and pouring it into the nested sieves, use a small amount of fresh water to rinse the remaining fines from the washing vessel.
- l. Adjust the volume of wash water to 1250 ± 10 mL with fresh water. Return the wash water to the collection pot taking care to include all water and fines.

Aggregates having a maximum nominal size of 25 mm (1 in.) or less

- a. Place the sample in the washing vessel.
- b. Add the measured amount of wash water, clamp the lid in place, and secure the wash vessel in the agitator and let it sit for $1 \text{ min} \pm 10 \text{ s}$.
- c. Start the agitator and agitate the vessel for a period of $2 \text{ min} \pm 10 \text{ s}$.
- d. Immediately following the agitation period, take the vessel from the agitator, and remove the lid.
- e. Bring the fines into suspension by holding the vessel in an upright position and moving it in a horizontal circular motion 5 or 6 times to cause the contents to swirl inside.
- f. Immediately pour all of the contents of the vessel into the 2.36 mm (No. 8) and 75 μm (No. 200) sieves nested over the collection pot.
- g. Use a small amount of fresh water to rinse the remaining fines from the washing vessel.
- h. Discard the material retained on the 2.36 mm (No. 8) sieve.
- i. If a concentration of material is retained on the 75 μm (No. 200) sieve, re-rinse the fine material by pouring the wash water through the sieve again, using the following procedure:
 1. Allow the wash water to stand undisturbed in the collection pot for a few moments to permit the heavier particles to settle to the bottom.
 2. Set the 75 μm (No. 200) sieve aside and pour the upper portion of the wash water into a separate container.
 3. Place the 75 μm (No. 200) sieve back on the collection pot, and pour the water back through the material on the 75 μm (No. 200) sieve. (If two collection pots are available, the specimen may be rinsed by alternately placing the sieve on one and then the other while pouring the wash water through the material on the sieve. Before each rinsing, allow the heavier particles to settle to the bottom, and pour only the upper portion of the water through the material.)
 4. Repeat this procedure as necessary until all of the 75 μm (No. 200) material has been washed through the sieve. When the material has been rinsed sufficiently, the material on the sieve will be free of visible streaks of clay, and the wash water will flow freely through the sieve and accumulated material.
- j. Discard the material retained on the 75 μm (No. 200) sieve.

- k. Pour the wash water into a graduated plastic beaker and adjust the volume to the original measure amount with fresh water. Return the wash water to the collection pot taking care to include all water and fines.
3. Fill the graduated plastic cylinder to the 3 unit mark with stock calcium chloride solution, and place the funnel on the graduated plastic cylinder.
4. Stir the wash water vigorously with one hand until all fines are in suspension. Use a circular motion allowing the fingers to rub the sides and bottom of the collection pot.
5. Immediately fill the graduated plastic cylinder to the 150 unit mark with the turbulent wash water.
6. Stopper the cylinder and thoroughly mix the wash water and calcium chloride solution by inverting the cylinder 20 times in approximately 35 seconds. Allow the air bubble to completely traverse the length of the cylinder each time, this counts as one inversion.
7. Immediately place the cylinder on a work bench or table free of vibrations, remove the stopper, and allow it to stand undisturbed for 20 min \pm 10 s.
8. At the end of the 20 minute period, read the top of the sediment column to the nearest 1 unit mark.
 - a. If a clearly defined line of demarcation does not form between the sediment and the liquid above it in the specified 20 minute period and the test was done with distilled or deionized water, allow the cylinder to stand undisturbed until the clear line of demarcation does form, then immediately read and record the time and the height of the column. If tap water was used, retest an untested portion of the same material using distilled or deionized water. If after 20 minutes there is no defined line of demarcation, consider the test invalid and a retest must be completed.
 - b. If the liquid immediately above the line of demarcation is still darkly clouded at the end of 20 minutes, and the line of demarcation, although distinct, appears to be in the sediment column itself, read and record the level of this line at the end of the specified 20-minute period. If tap water was used, retest an untested portion of the sample using distilled or deionized water.

CALCULATIONS

Sediment height to the nearest unit on the graduated plastic cylinder equals the % C.V. (Example: 4 units = 89% C.V.)

CLEANNES VALUES (C.V.) FOR 0 TO 150 UNITS SEDIMENT HEIGHT READINGS (H)

SEDIMENT HEIGHT (UNITS)	C.V. (%)	SEDIMENT HEIGHT (UNITS)	C.V. (%)	SEDIMENT HEIGHT (UNITS)	C.V. (%)	SEDIMENT HEIGHT (UNITS)	C.V. (%)	SEDIMENT HEIGHT (UNITS)	C.V. (%)
0	100	31	45	62	23	93	12	124	4
1	97	32	44	63	23	94	11	125	4
2	94	33	43	64	22	95	11	126	4
3	91	34	42	65	22	96	11	127	4
4	89	35	41	66	21	97	11	128	4
5	86	36	40	67	21	98	10	129	3
6	84	37	40	68	21	99	10	130	3
7	81	38	39	69	20	100	10	131	3
8	79	39	38	70	20	101	9	132	3
9	77	40	37	71	19	102	9	133	3
10	75	41	36	72	19	103	9	134	3
11	73	42	36	73	18	104	9	135	2
12	71	43	35	74	18	105	8	136	2
13	69	44	34	75	17	106	8	137	2
14	68	45	33	76	17	107	8	138	2
15	66	46	33	77	17	108	8	139	2
16	64	47	32	78	16	109	7	140	2
17	63	48	32	79	16	110	7	141	1
18	61	49	31	80	15	111	7	142	1
19	60	50	30	81	15	112	7	143	1
20	58	51	29	82	15	113	7	144	1
21	57	52	29	83	15	114	6	145	1
22	56	53	28	84	14	115	6	146	1
23	54	54	28	85	14	116	6	147	0
24	53	55	27	86	14	117	6	148	0
25	52	56	26	87	13	118	6	149	0
26	51	57	26	88	13	119	5	150	0
27	49	58	25	89	13	120	5		
28	48	59	25	90	13	121	5		
29	47	60	24	91	12	122	5		
30	46	61	24	92	12	123	5		

1. When two or more primary sizes of coarse aggregate are combined in a mix, determine the weighted-average Cleanness Value for the mix. For Portland cement concrete mixes, calculate the weighted-average Cleanness Value using the combinations shown below regardless of the actual proportions to be used on the project.

- a. 37.5 mm (1 ½ in.) maximum aggregate mix:

37.5 mm x 19.0 mm (1 ½ in. x ¾ in.) ... 40%
25 mm x 4.75 mm (1 in. x No. 4) ... 60%

Example:

(For ¾ in. aggregate) $91 \times 0.40 = 36.4$
(For No. 4 aggregate) $89 \times 0.60 = 53.4$
 $36.4 + 53.4 = 89.8 = 90\% \text{ C.V.}$

- b. 63 mm (2 ½ in.) maximum aggregate mix:

63 mm x 37.5 mm (2 ½ in. x 1 ½ in.) ... 30%
37.5 mm x 19.0 mm (1 ½ in. x ¾ in.) ... 30%
25 mm x 4.75 mm (1 in. x No. 4) ... 40%

Example:

(For 1 ½ in. aggregate) $84 \times 0.30 = 25.2$
(For ¾ in. aggregate) $77 \times 0.30 = 23.1$
(For No. 4 aggregate) $91 \times 0.40 = 36.4$
 $25.2 + 23.1 + 36.4 = 84.7 = 85\% \text{ C.V.}$

REPORT:

Report the Cleanness Value to the nearest whole number and record on NDOT form 040-035.

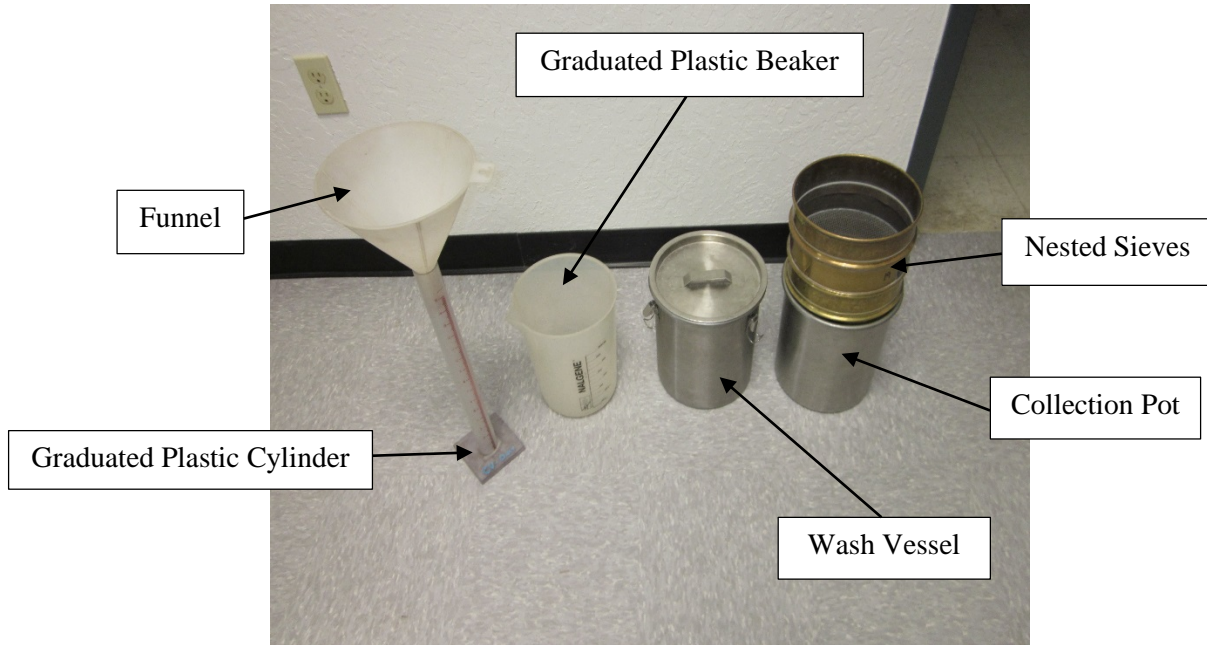

Figure 1



Figure 2
Agitator and Wash Vessel



Figure 3
Rocker and Box Sieve Assembly



Figure 4
Rocker and Box Sieve Assembly

State of Nevada
Department of Highways
Materials and Testing Division

METHOD OF TEST FOR DETERMINING THE PERCENT OF FRACTURED FACES

SCOPE

This test method determines the percentage, by weight, of aggregate particles with at least one fractured face. A particle is defined to be fractured if it has a rough surface texture caused by natural or mechanical means.

APPARATUS

1. Balance, with a minimum capacity of 12,000 g and sensitive to 0.1 g.
2. Sieve, 4.75 mm (No. 4).
3. Spatula, tool to aid in sorting aggregate particles.

SAMPLE PREPARATION

1. Obtain a representative sample per Test Method Nev. T200.
2. Obtain a representative portion of the sample per Test Method Nev. T203. Use the following table to obtain the minimum oven-dry weights for the different sizes of aggregates:

<u>Aggregate size</u>	<u>Weight in grams</u>
Pass 50 mm (2 in.)	4,000 ± 100 g
Pass 25 mm (1 in.)	2,500 ± 50 g
Screenings and open-graded plantmix aggregate	1,000 ± 50 g

3. If the + 4.75 mm (+ No. 4) material is extremely dirty (material caked on + 4.75 mm (+ No. 4) material, wash the sample before drying.
3. Dry the sample per Test Method Nev. T112.
4. Separate the test sample into two portions by means of a 4.75 mm (No. 4) sieve. Keep the portion retained on the 4.74 mm (No. 4) sieve and waste the portion passing the 4.75 mm (No. 4) sieve.

NOTE: Sample may be obtained per Test Method Nev. T206 after the sieving operation has been completed. Keep the portion retained on the + 4.75 mm (+ No. 4) sieve and start with the "PROCEDURE" section below.

PROCEDURE

1. Weigh the portion retained on 4.75 mm (No. 4) sieve and record to the nearest whole gram as "Total Weight of Sample".
2. Spread sample out on a worktable, using large enough area so that individual particles can be closely inspected.
3. Use the spatula to separate the particles into two separate piles. One pile with one or more fractured faces and the other pile with no fractured faces.
4. Weigh the pile with one or more fractured faces to the nearest whole gram as "Weight of Fractured Aggregate".

CALCULATIONS

$$\text{Percent Fractured Faces} = \frac{\text{Weight of fractured aggregate}}{\text{Total weight of sample}} \times 100$$

REPORT

Record all the weights on NDOT form 040-013. Report the percent of aggregate particles with fractured faces calculated to the nearest whole number on NDOT form 040-010.

State of Nevada
Department of Highways
Materials and Testing Division

METHOD FOR DETERMINATION OF COMPRESSIVE
STRENGTH OF CEMENT TREATED BASE AND
CEMENT TREATED SUBGRADE
(FIELD METHOD)

SCOPE

This method covers the procedure for determining the compressive strength of cement treated material, and also provides a guide for maintaining optimum moisture conditions in the field.

FIELD METHOD

A. APPARATUS

1. Balance with capacity of 5,000 g, accurate to 1 g
2. Split compaction mold, 4-in. diam. x 11.5 in. as shown in Figure I.
3. One compression machine consisting of a 12-20 ton capacity hydraulic jack fitted with a spherically seated head and mounted in a 30-in. frame.
4. Tamper, rod, tin liners and bottom and upper plunger as shown in Figure I.
5. Measuring gauge and stand as shown in Figure II.
6. Special bench vise for holding compaction and mold as shown in Figure II.
7. 6 x 12-in. concrete cylinder cans with lids.
8. Two 6 x 6-in. glass plates for each specimen.
9. Miscellaneous items such as spoons, spatulas, scoops, scotch tape, etc.
10. Water tank 6-in. deep for use in submerging test specimens.
11. Sample splitter, riffle type, 3/4-in. openings.

B. MATERIALS

1. A supply of gypsum casting plaster.
2. Supply of 1/2-in. adhesive tape.

C. PROCEDURE FOR THE FABRICATION OF TEST SPECIMENS

1. Obtain representative samples of the freshly mixed materials daily. Normally, two samples should be taken, one from the mixing plant and one from the street immediately ahead of rolling operations. To protect against the loss of moisture, place all samples in 6 x 12-in. concrete cylinder cans and immediately cover.
2. Transport the cans to the point of fabrication and fabricate samples with the least possible delay. Protect against loss of moisture at all times.
3. Immediately upon arrival at the point of fabrication, remix the sample and screen through a 1-in. sieve. Only the minus 1-in. material is used in making test specimens.
4. Quarter out the approximate amounts required for the moisture determination and test specimen. The amount of material for moisture samples should be approximately 1,000 g. The amount of material needed for fabricating a test specimen is shown in Table II. It is of extreme importance that test specimens be fabricated as soon as possible after the mixing process. The hydration of the cement can cause a serious loss of compressive strength as well as a reduction in the density of the test specimen.
5. Weigh the material for both moisture samples and test specimens to the nearest gram, and weigh as rapidly as possible to avoid loss of moisture. Protect all material for test specimens against loss of moisture after weighing, and do not delay between weighing and fabricating.
6. Assemble the 4-in. mold with the tin liner in place and the plunger held one space from the bottom by means of the pin. (For some soils it may be necessary to hold the bottom plunger further from the end of the mold in order to prevent the rim of the mold from coming in contact with the shoulder of the plunger before compaction is completed. In such cases, insert the pin through successively higher holes until satisfactory results are secured).
7. Place the extension sleeve on top of the mold and add approximately one-half of the weighed sample with a scoop or large spoon. If the material contains rock particles larger than 1/4 in., rod 25 to 30 times with a 3/8 in. bullet-nosed rod during this operation, in order to prevent the formation of rock pockets at the bottom or sides of the specimen. Tamp the first layer of material 50 blows with the small end of the 6 lb. hand tamper. Physical exertion in tamping should be only sufficient to move the tamper over the entire surface of the specimen. The actual compactive effort should be provided only by the weight of the tamper, using the hand as a guide. Avoid having a smoothly compacted surface at this stage because it will result in a compaction plane in the specimen when the next layer is tamped, and this would prevent the two layers from being bonded together.
8. Place the remaining portion of the sample in the mold and rod if sample contains coarse aggregate. It is not necessary to rod fine material such as

sand. Tamp the second layer using 100 blows with the small end of the hand tamper. Level off the top of the compacted specimen by tamping lightly with the large end of the tamper in order to provide a smooth surface on an even plane at right angles to the axis of the mold. After tamping is completed, remove the extension sleeve.

9. Place the top plunger in position, then place the entire assembly on the hydraulic jack in the compression frame. If necessary, place one or more of the spacing rings between the top plunger and the top of the frame to prevent excessive travel of the jack. Remove the pin that holds the bottom plunger in place and gradually apply a total load of 25,000 lb.; use 1 min. to attain the first 20,000 lb., 1/2 min. for the next 5,000 lb. and hold the 25,000 lb. load for 1 min. Then release the load, place the mold in the vise, take out the plungers, open the mold, remove the specimen with its tin jacket and weigh.
10. Determine the height with the measuring gauge, by seating the circular measuring guide firmly on top of the cylinder. Care must be taken to seat the dial indicator tip properly in the center of the measuring guide. The height measurement is illustrated in Figure II.
11. If water is squeezed out of the specimen during compaction, a notation should be made of the amount as a guide in maintaining optimum moisture control in the field. This is done by taking the difference between the net weight of the specimen and the net weight of the sample used. Headquarters laboratory will normally make optimum moisture determination on preliminary samples which may serve to compare with field results. However, in applying optimum moisture control in the field, consideration must be given to evaporation losses in mixing and handling and allowances made accordingly.
12. Determine the moisture content of the sample by weighing the material set aside for this purpose (approx. 1,000 g.) to the nearest gram and drying on a hot plate to constant weight.

$$\text{Percent moisture} = \frac{\text{Wet Weight} - \text{dry weight}}{\text{Dry weight}} \times 100$$

13. After determining the height and weight of the compacted specimen, print the proper identifying marks on the side of the tin liner with an indelible pencil. Place tin caps on each end and seal with masking tape.

D. PROCEDURE FOR THE DETERMINATION OF COMPRESSIVE STRENGTH IN THE FIELD

1. If it is necessary that compressive strengths be determined on the job, the test specimens should be cured for 6 days. The curing shall be accomplished by placing lids on each end of the tin sleeve, sealing with adhesive tape and then storing in a cool place such as the shady side of a building. However, during cold weather the test specimens should be protected from freezing. At the end of the 6-day curing period, remove the caps and liners and transfer the identifying marks to the side of the specimen with an indelible pencil.

2. Immerse the specimens in water for 1 day in order to complete the 7-day curing period required for the compressive strength test.
3. Remove the specimens from the water bath, wipe the surfaces with a dry rag and cap both ends of each specimen with gypsum casting plaster as follows:
 - a. Select two glass plates, approximately 6 x 6 in., for each specimen and lay them out on a table or bench.
 - b. Oil the top of each glass with common motor lubricant.
 - c. Measure out into a suitable container about a cup of gypsum casting plaster for each specimen to be capped.
 - d. Add water and mix to a fairly thick paste.
 - e. Place a tablespoonful of paste on top of each test specimen and immediately force one of the plates down on the paste on top of each specimen to form full caps.
 - f. Place a tablespoonful of paste on each of the other glass plates and press each of the specimens firmly on a glass plate so as to form full caps.
 - g. Allow the caps to harden for a minimum of 30 min. and then remove the glass plates by tapping the edges lightly with a piece of soft wood. If difficulty is experienced in removing the plates, apply warm water and continue tapping lightly.
4. The specimen may be tested for compressive strength as soon as the glass plates are removed. Center the specimen on the head of the hydraulic jack in the compression machine and apply the load at the rate of between 20 and 50 lb. per square inch per second. A convenient rate of loading when using the compression machine on a 4-in. diam. test specimen is 30,000 lb. per minute. This allows easy conversion in the field to desired load-time units (i.e., 500 lb. per second). Apply the load until ultimate fracture of the test cylinder occurs. An initial fracture will usually occur at approximately 80 percent of the load required for ultimate fracture.
5. Report the test results as compressive strength in pounds per square inch which equals the total compression load divided by the end area of the 4-in. dia. test specimen (12.57 sq. in.). Table I lists the unit compressive stress in increments of 500-lb. total load.

TABLE I

TABLE OF UNIT COMPRESSIVE STRENGTH 4-IN. DIAMETER
CEMENT TREATED BASE SPECIMEN

Total Load (lbs.)	Compressive Strength (psi)	Total Load (lbs.)	Compressive Strength (psi)	Total Load (lbs.)	Compressive Strength (psi)
500	40	10,500	840	20,500	1,640
1,000	80	11,000	880	21,000	1,680
1,500	120	11,500	920	21,500	1,720
2,000	160	12,000	960	22,000	1,760
2,500	200	12,500	1,000	22,500	1,800
3,000	240	13,000	1,040	23,000	1,840
3,500	280	13,500	1,080	23,500	1,880
4,000	320	14,000	1,120	24,000	1,920
4,500	360	14,500	1,160	24,500	1,960
5,000	400	15,000	1,200	25,000	2,000
5,500	440	15,500	1,240	25,500	2,040
6,000	480	16,000	1,280	26,000	2,080
6,500	520	16,500	1,320	26,500	2,120
7,000	560	17,000	1,360	27,000	2,160
7,500	600	17,500	1,400	27,500	2,200
8,000	640	18,000	1,440	28,000	2,240
8,500	680	18,500	1,480	28,500	2,280
9,000	720	19,000	1,520	29,000	2,320
9,500	760	19,500	1,560	29,500	2,360
10,000	800	20,000	1,600	30,000	2,400

PROCEDURE FOR DETERMINING THE DENSITY OF TEST SPECIMENS

The density of the test specimen, based on the dry weight of material, is calculated from the data obtained in the Procedure for the Fabrication of Test Specimens using the following formula:

$$D = \frac{30.3 Ww}{(100 + M)H}$$

Where:

D = Dry density of the test specimen in lb. per cu. ft.

Ww = Wet weight of the test specimen in grams.

M = Percent moisture of the sample.

H = Height of the test specimen in inches.

30.3 = Constant used to convert weight in grams to pounds per cubic foot for a 4-in. diam. specimen having the height measured in inches.

REFERENCE

Test Method Nev. 203
Test Method No. Calif. 901
Test Method No. Calif. 905

TABLE II

TABLE OF WEIGHTS FOR FABRICATING 4-IN. DIAMETER X 4-IN. HIGH
TEST SPECIMENS OF VARIOUS WEIGHTS PER CU. FT.

Total Grams CTB

<u>Density</u> <u>lbs./cu. ft.</u>	<u>6%</u> <u>moist.</u>	<u>7%</u> <u>moist.</u>	<u>8%</u> <u>moist.</u>	<u>9%</u> <u>moist.</u>	<u>10%</u> <u>moist.</u>	<u>11%</u> <u>moist.</u>	<u>12%</u> <u>moist.</u>
115	1609	1624	1640	1655	1670	1685	1700
116	1623	1639	1654	1669	1684	1700	1715
117	1637	1653	1668	1684	1699	1714	1730
118	1651	1668	1682	1698	1714	1729	1745
119	1665	1681	1697	1712	1728	1744	1759
120	1679	1695	1711	1727	1743	1758	1774
121	1693	1709	1725	1741	1757	1773	1789
122	1707	1723	1739	1756	1772	1788	1804
123	1721	1737	1754	1770	1786	1802	1819
124	1735	1752	1768	1784	1801	1817	1833
125	1749	1766	1782	1799	1815	1832	1848
126	1763	1779	1796	1813	1829	1846	1863
127	1777	1793	1810	1827	1844	1860	1877
128	1791	1808	1825	1842	1859	1876	1893
129	1805	1822	1839	1856	1873	1890	1907
130	1819	1836	1853	1870	1888	1905	1922
131	1833	1850	1867	1885	1902	1919	1936
132	1847	1864	1881	1899	1916	1934	1951
133	1861	1879	1896	1914	1932	1949	1967
134	1875	1893	1911	1928	1946	1964	1981
135	1889	1907	1925	1942	1960	1978	1996
136	1903	1921	1939	1957	1974	1992	2010
137	1916	1935	1953	1971	1989	2007	2025
138	1931	1950	1968	1986	2004	2022	2041
139	1945	1963	1982	2000	2018	2037	2055
140	1959	1977	1996	2014	2033	2051	2070
141	1973	1992	2010	2029	2048	2066	2085
142	1987	2006	2025	2043	2062	2081	2100
143	2001	2020	2039	2058	2077	2095	2114
144	2015	2034	2053	2072	2091	2110	2129
145	2029	2048	2067	2087	2106	2125	2144
146	2043	2062	2082	2101	2120	2139	2159
147	2057	2076	2096	2115	2135	2154	2173
148	2071	2091	2110	2130	2149	2169	2188
149	2085	2105	2124	2144	2164	2183	2203
150	2099	2119	2139	2158	2178	2198	2218

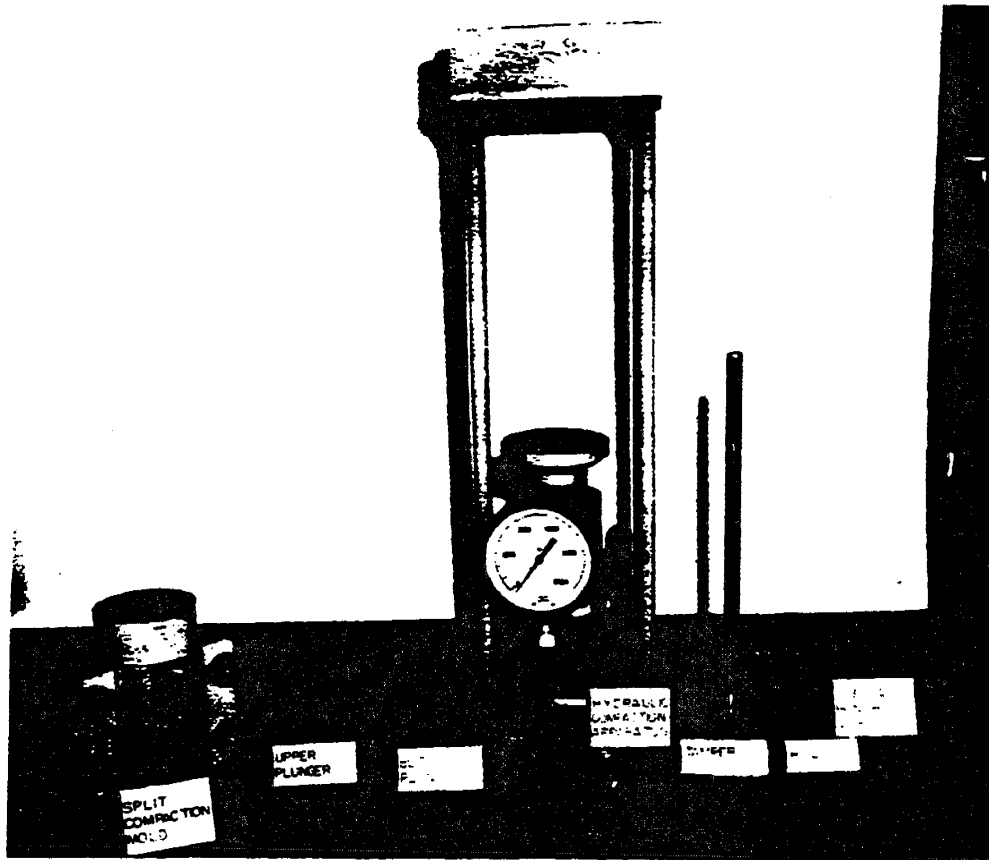

FIGURE 1

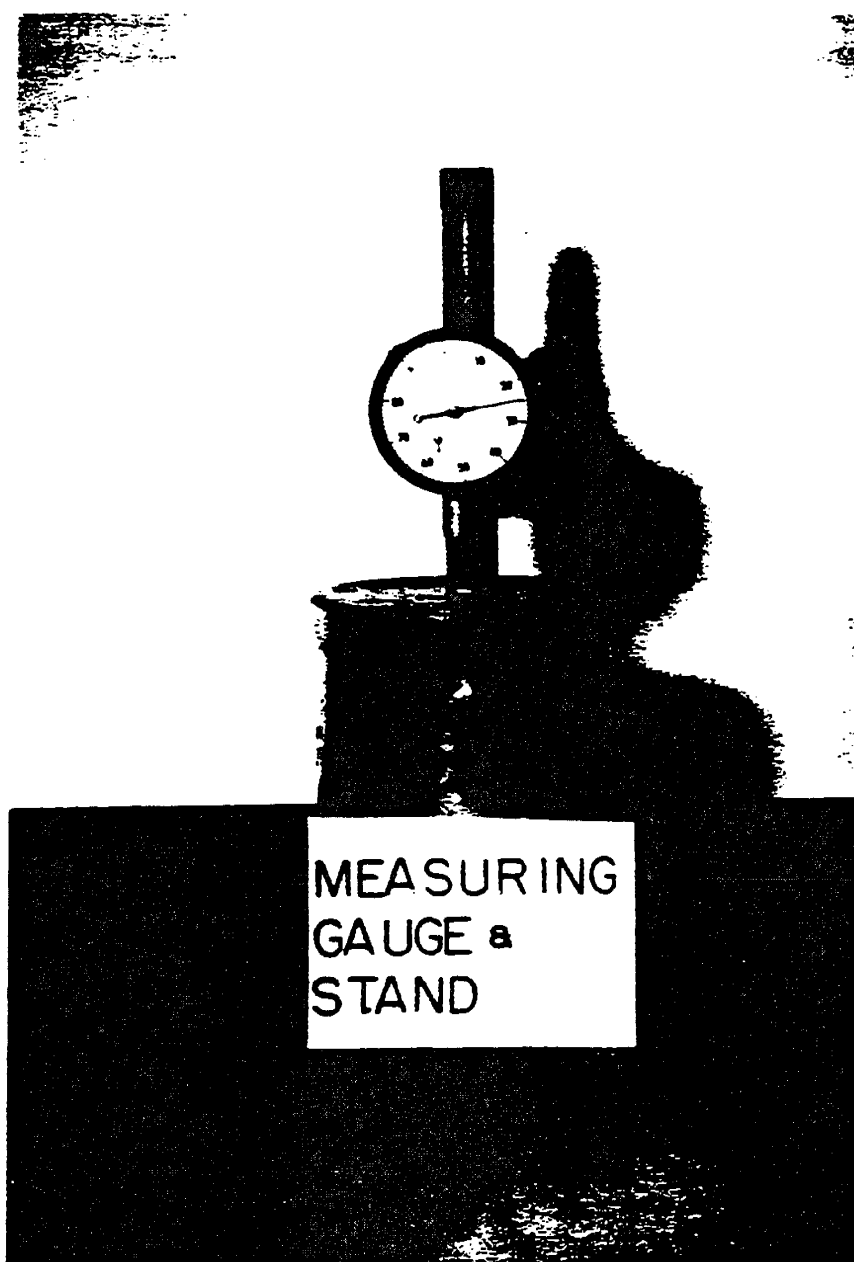

FIGURE 2

State of Nevada
Department of Highways
Materials and Testing Division

METHOD FOR DETERMINATION OF THE CEMENT CONTENT OF
CEMENT TREATED BASE AND CEMENT TREATED SUBGRADE

SCOPE

This method describes the procedure for determining the cement content of cement treated materials by a rapid chemical analysis.

A. PRINCIPLE:

A 10% ammonium chloride solution is used as the solvent system for the calcium compounds present in Cement Treated Base Materials. The solution is titrated with the disodium salt of EDTA (ethylenedinitrilotetra-acetic acid) after adjustment of pH, using Hydroxynaphthol Blue as indicator. Cement content is determined from a standard graph after subtracting the aggregate blank.

B. EQUIPMENT: (For field use).

- 6 - 10 ml volumetric pipettes
- 2 - 25 ml burettes
- 1 - Magnetic Stirrer and Stirring Bar
- 1 - Burette Stand
- 6 - 250 ml Erlenmeyer flasks
- 6 - 2qt. Polyethylene Jugs (Fruit juice containers from any Variety Store have proven satisfactory and economical).
- 6 - Stainless Steel stirring rods (12 to 14 in.)
- 1 - Harvard Trip Balance with tared pan.
- 1 - 25 ml graduated cylinder
- 1 - 1,000 ml graduated cylinder
- 1 - Plastic funnel (12 in. diam.)
- 2 - 5 gal Polyethylene jugs for distilled water
- 1 - 5 gal Polyethylene jug for ammonium chloride
- 6 - Medicine droppers
- 1 - Pkg. pH indicator paper range 10 to 14.

C. REAGENTS:

1. EDTA, 0.1 M. Weigh 116.88 gms of EDTA (acid), A.C.S. Reagent grade, into a 3 L beaker. Add approximately 1.5 L of distilled water and place on stirrer. Add sodium hydroxide pellet by pellet until the acid is completely dissolved. Make up to exactly 4 L and transfer to a 1 gal. polyethylene bottle. This solution must be stored in plastic. (For field use this solution will be made up and distributed by Headquarters Laboratory.)
2. Ammonium chloride solution, 10%. Transfer 1893 gms of U.S.P. Granular Ammonium Chloride to a 5 gallon plastic bottle. Make up to 5 gallons with distilled water with thorough mixing.

3. Sodium Hydroxide, 50%. Dissolve 500 gms of sodium hydroxide pellets in distilled water and dilute to 1 L. Use caution, store in plastic when cool. Dilute 1 to 1 with distilled water for use. (For field use this solution will be made up and distributed by Headquarters Laboratory.)
4. Triethanolamine, 20%. Dilute 100 ml of triethanolamine to 500 ml with distilled water. (For field use this solution will be made up and distributed by Headquarters Laboratory.)
5. Hydroxynaphthol Blue. Obtain from Headquarters.

CAUTION: All equipment must be kept scrupulously clean and thoroughly rinsed with distilled water. All reagents must be stored in polyethylene containers.

D. PROCEDURE: Preparation of Curve:

Prepare three duplicate sets of samples as follows:

- Set 1. Transfer two 300 gm samples of aggregate at the planned moisture content for the job, to separate plastic containers. (Note: The water used in bringing up the moisture to the correct amount should be the same as that used at the job site.)
- Set 2. Prepare two samples as above containing 2.0 percent cement of the type to be used on the job.
- Set 3. Repeat Set 1, preparing two samples containing 3.0 percent cement.

Proceed with each sample as with production samples described in Section E. Then construct a graph showing net mls.* EDTA vs. percent cement, using the average figures from Sets 1, 2, and 3. This should yield a straight line. Set 1 corresponds to the blank for the aggregate being used.

*Net mls. EDTA = Total mls. minus mls. for blank. Thence a new curve need not be prepared if only the blank changes.

E. PRODUCTION SAMPLES:

Make up a sample of exactly 300 grams, and place the sample into a 2 qt. plastic container, and add 600 mls of ammonium chloride solution. Stir EXACTLY 2 minutes with a stainless steel stirring rod, allow to settle EXACTLY 4 minutes and then pipette a 10 ml aliquot of the supernatant solution into a 250 ml Erlenmeyer flask. Add approximately 75 ml of distilled water and with thorough mixing add the diluted sodium hydroxide (NaOH) dropwise until a pH between 13.0 and 13.5 is obtained, using the pH indicator paper as a control. Add 4 drops of 20% Triethanolamine solution and then add the Hydroxynaphthol Blue indicator. Titrate with EDTA to a pure blue endpoint.

Subtract the blank from your final reading and determine the cement content from the previously prepared graph.

State of Nevada
Department of Transportation
Materials Division

METHOD OF TEST FOR DETERMINING MOISTURE CONTENT OF BITUMINOUS MIXTURES USING MICROWAVE OVENS

SCOPE

This test method provides a rapid field test procedure for determining the moisture content of bituminous mixtures.

APPARATUS

1. Microwave oven, capable of holding a 4,000 g sample.
2. Sample container, capable of holding 600 g (paper, glass or ceramic).
3. Balance, with 1,000 g capacity and sensitive to 0.1 g.
4. Gloves, heat resistant.
5. Glass beaker or plastic container, minimum 600 mL.

SAMPLE PREPARATION

1. Obtain a representative sample per Test Method Nev. T200.
2. Obtain a 500 ± 50 g representative portion of the sample per Test Method Nev. T203.

NOTE: If the bituminous sample is thoroughly dried in an oven overnight, until a constant weight is achieved, then the moisture test is not required and 0% will be placed in the moisture content (MC) field on NDOT form 040-050, make a note that it was oven dried.

PROCEDURE

1. Place 600 mL glass beaker filled with water in the microwave oven, keep the beaker at least half full at all times.
2. Place the sample in a tared sample container and weigh to the nearest 0.1 g.

3. Place the weighed container with sample in the microwave oven and turn the microwave oven on for 5 minutes.
4. After 5 minutes, turn the microwave oven off, remove the container with the sample, weigh the container with the sample to the nearest 0.1 g, and record the weight.
5. Place the container with the sample back in the microwave oven. Change the water in the 600 mL beaker, to avoid the water from boiling over onto the drying sample. Turn the microwave oven on and dry the sample for 2 additional minutes.
6. Remove the container with sample from the microwave oven; weigh to the nearest 0.1 g, and record weight.
7. Repeat steps 5 and 6 until a constant weight is obtained. In most cases, a 10 minute drying period is sufficient.

NOTE: When determining the moisture content of bituminous plantmix, if the sample starts smoking, immediately turn off the microwave oven, weigh and record the sample weight, this will be the end of the moisture test. If smoke is present, then the oil is beginning to burn and the process is complete.

CALCULATIONS

After a constant weight has been obtained, calculate the moisture content of the sample as follows:

$$\% \text{ Moisture Content} = \frac{(\text{Initial Mass (Wet Weight)} - \text{Final Mass (Dry Weight)})}{\text{Final Mass (Dry Weight)}} \times 100$$

REPORT

Record all weights on NDOT form 040-050. Moisture content shall be reported to the nearest 0.01%.

PRECAUTIONS

1. Use gloves for handling hot mixtures when placing in or removing from the microwave oven.
2. Do not use metal containers in the microwave oven at any time. Damage to the microwave oven will occur.
3. When weighing samples, do so with a buffer to avoid error in the balance due to heat transfer. A buffer such as: wooden stakes, sieve pan or other suitable device that can be placed on the balance.
4. The same balance should be used to obtain all the weights for this test method.

State of Nevada
Department of Transportation
Materials Division

METHOD OF TEST FOR THE DETERMINATION OF THEORETICAL MAXIMUM SPECIFIC GRAVITY OF UNCOMPACTED BITUMINOUS PAVING MIXTURES (FIELD METHOD)

SCOPE

This test method covers the procedure to determine the theoretical maximum specific gravity of uncompacted bituminous paving mixtures using a vacuum pycnometer (Rice Pot) secured to a mechanical vibrating device. The theoretical maximum specific gravity determined by this test shall be used for determining relative percent compaction of bituminous paving mixtures in the field.

APPARATUS

1. Aluminum volumetric canister (pycnometer bowl) equipped with a solid lid, minimum 2000 g capacity 190 mm (7 1/2 in.) ID x 152 mm (6 in.) depth solid-wall cylinder.
2. Plexiglas vacuum lid, fitted with a rubber gasket, release valve and a connection for the vacuum line.
3. Mechanical vibrating device, equipped with a timer, vibration speed control and a detachable collar to which the vacuum pycnometer can be fastened.
4. Vacuum pump, capable of 27.5 ± 2.5 mm Hg and miscellaneous equipment necessary to evacuate air from the vacuum pycnometer.
5. Manometer, capable of 27.5 ± 2.5 mm Hg.
6. Balance, having a capacity of 12000 g and sensitive to 0.1 g.
7. Oven, capable of maintaining temperatures of $110 \pm 5^\circ\text{C}$ ($230 \pm 9^\circ\text{F}$)
8. Thermometer, to measure and maintain a water bath temperature of $25 \pm 5^\circ\text{C}$ ($77 \pm 9^\circ\text{F}$)
9. Sieve, 6.3 mm (1/4 in.)

NOTE: See Figure 1 for example of correct configuration of testing apparatus.

SAMPLE PREPARATION

1. Obtain a representative sample of bituminous paving mixture per Test Method Nev. T200.
2. Obtain a representative sample in accordance with Test Method Nev. T203. The size of the sample shall conform to the following requirements:

Table 1 – Minimum Sample Sizes

Nominal Maximum Aggregate Size, mm (in.)	Minimum Sample Size, g
19 to 25 (3/4 to 1)	2500
12.5 (1/2) or smaller	1500

3. Using a 6.3 mm (1/4 in.) sieve, separate the particles of the representative paving mixture sample by hand, taking care to avoid fracturing the aggregate, so that the finer aggregate portions will pass through the 6.3 mm (1/4 in.). If the paving mixture sample is not pliable enough to be separated manually, place the material in a large sample pan and warm it in an oven until it can be separated as described above.
4. Cool the sample to room temperature. Recombine the coarse and fine aggregate particles and record its weight to the nearest 0.1 g (Mass of dry sample in air).

PROCEDURE

1. As necessary, clean and lightly lubricate the Plexiglas vacuum lid gasket using petroleum jelly.
2. On a smooth and level surface, completely fill the pycnometer bowl with water at 25 ± 3 °C (77 ± 5 °F). Lightly place the pycnometer lid on the pycnometer bowl, allowing it to settle into place by its own weight. To remove any entrapped air, gently push the pycnometer lid down until water is ejected from the aperture on the top of the pycnometer lid. Thoroughly dry the outside of the pycnometer and record its weight to the nearest 0.1 g (Mass of pycnometer and water).

NOTE: This weight should be verified periodically. Perform step 2 if parts of the pycnometer have been replaced or altered in any way.

3. Empty the pycnometer bowl.
4. Place the room temperature paving mixture sample into the empty pycnometer bowl and fill the pycnometer bowl with a sufficient amount of water 25 ± 3 °C (77 ± 5 °F) to completely submerge the sample. Place the bowl onto the mechanical vibrating device, affix the Plexiglas vacuum lid onto the pycnometer bowl and fasten the assembly together using the detachable collar.

5. Turn on the vacuum pump and close both the bleeder and monometer valves to remove the entrapped air in the sample by applying 27.5 ± 2.5 mm Hg of absolute pressure for 15 ± 2 minutes. Constantly agitate the container and sample using the mechanical vibrating device during the vacuum period.

NOTE: The speed control adjustment should be closely monitored as to avoid over-agitation and stripping of asphalt in the sample and that water is not drawn into the vacuum line.

6. At the end of the vacuum period and before turning off the vacuum pump, open the bleeder valve located on the Plexiglas vacuum lid and the monometer valve to release the pressure in the pycnometer. Remove the Plexiglas vacuum lid from the pycnometer bowl.
7. Adjust the contents of the pycnometer bowl by filling the pycnometer bowl with a sufficient amount of water at 25 ± 3 °C (77 ± 5 °F). If the temperature of the pycnometer bowl is found to be above or below 25 ± 3 °C (77 ± 5 °F), carefully remove a small amount of water and repeat the process until the contents of the pycnometer have stabilized to within the required tolerance.
8. The pycnometer bowl shall be completely filled with water at the end of step 7. Lightly place the pycnometer lid on the pycnometer bowl, allowing it to settle into place by its own weight. To remove any entrapped air, gently push the lid down until water is ejected from the aperture on the top of the pycnometer lid. Thoroughly dry the outside of the pycnometer bowl and pycnometer lid and record its weight within 10 ± 1 minutes of completing the vacuum procedure to the nearest 0.1 g (Mass of evacuated sample, pycnometer and water)

CALCULATIONS

Calculate the theoretical maximum specific gravity of the uncompacted bituminous paving mixture as follows:

$$\text{Specific Gravity} = A / [(A+B)-C]$$

Where:

A = Mass of dry sample in air

B = Mass of pycnometer and water

C = Mass of evacuated sample, pycnometer and water

REPORT

Specific gravity shall be reported to the nearest 0.001.

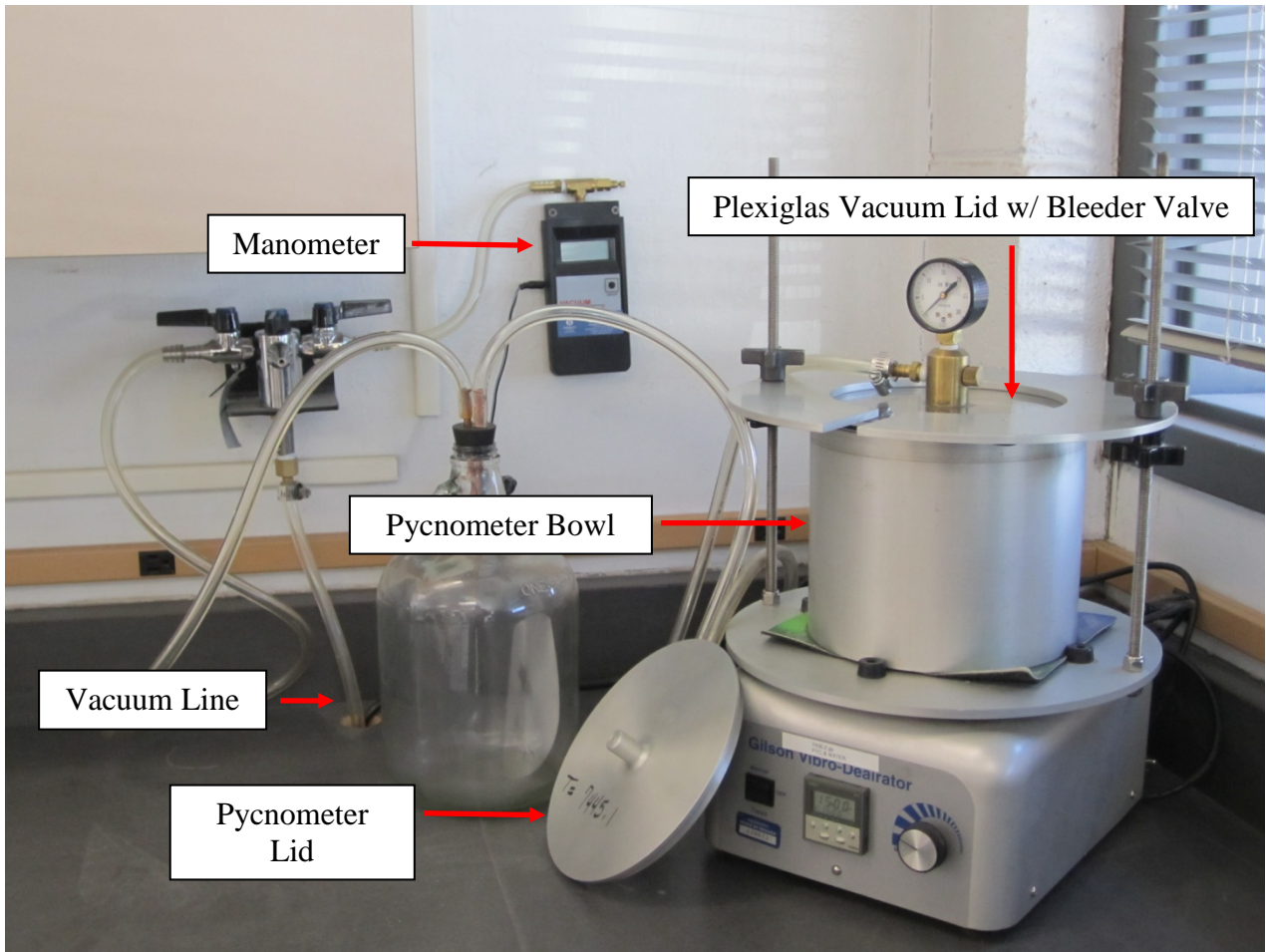

Figure 1

State of Nevada
Department of Transportation
Materials Division

**METHOD OF TEST FOR RELATIVE COMPACTION OF PLANTMIX BITUMINOUS SURFACE
USING A NUCLEAR DENSITY GAUGE**

SCOPE

This test method is designed to measure the degree of compaction of plantmix base and surface mat and joint density, using a nuclear density testing device.

APPARATUS

1. Thin Layer Density Gauge, Troxler Model 4640-B or 3450.
2. Magnesium reference block.
3. Air gap spacer.

STANDARDIZATION

1. Warm up period: Turn the thin layer density gauge on and warm up for ten minutes. This allows the regulators and deflectors to stabilize.
2. At the start of each shift, standardize the thin layer density gauge to check equipment operation. This procedure can also be used as an operational check whenever test measurements are suspect.
3. The site chosen for standardization should remain the same throughout the contract. Outline the magnesium reference block with keil (lumber crayon) to ensure the same location is used.
4. Place the magnesium reference block on a solid surface having a density of 1600 kg/m^3 (100 lb/ft^3) or greater, preferably a plantmix or concrete surface approximately 10 cm (4 in.) thick. Ensure that the magnesium reference block is level and does not rock back and forth. This location should be at least 3 m (10 ft) away from any large object such as a vehicle, field lab, wall or any water source and at least 9 m (30 ft) from any other nuclear gauge.
5. Place the air gap spacer on the magnesium reference block and then place the thin layer density gauge on top of the air gap spacer. The handle end of the gauge should rest over the two posts on the air gap spacer. Verify that the "Standard Mode" is in multi-standard mode.
6. With the lock attached and the handle in the safe position, press the "STANDARD" key on the keypad. The screen will display "Standard Count XXXX XXXX Take a new standard count?" Press the "YES" key. The screen will then show "Place gauge on spacer and both on block, put the rod in safe position, press enter." Check to make sure the thin layer density gauge does not rock, then

press the “START/ENTER” key. The thin layer density gauge will begin taking a four minute standard count.

7. When counting stops, at the end of the four minutes, screen will display “Standard # 1 XXXX X.XX% Pass Standard # 2 XXXX X.XX% Pass Use new standards?” If it shows a PASS/PASS, record the Standard #1 and Standard #2 in the gauge log book. Press the “YES” key. If you receive a PASS/PASS to the right of the percentages, it indicates that the standard counts are within the 1% maximum allowed variation for System 1 reference standard counts and 1.2% maximum allowed variation for System 2 standard counts.
8. If the standard counts for System 1 or System 2 fail, the screen will display “Do you want to use the new STD?” Press the “YES” key. Check the thin layer density gauge to make sure that the magnesium reference block does not rock, no other gauges are in the area and that the standard mode is in multi-standard mode. Then take another standard count.
9. It may take up to five standard counts before obtaining a PASS/PASS result. In the event that a PASS/PASS result is not obtainable, contact the Independent Assurance Lab for further assistance.

CORRELATION WITH DRILLED CORES

1. Perform correlation tests at seven locations within one test section. Thin layer density gauge correlation shall be performed on each mix design and on each different surface of paving (EX. Milled Surface, Second Lift, Type 1 Class B Base etc.). Take the thin layer density gauge shots first and record on NDOT form 040-017. Outline around the base of the thin layer density gauge with Kiel (lumber crayon). For each 1 minute test rotate the thin layer density gauge 90 degrees about the center of the thin layer density gauge for a total of four times at each location. Refer to Figure 1 for the correct positioning of the thin layer density gauge during correlation. Repeat this process at all seven locations.
2. Take the cores from the pavement after the mat has cooled enough to allow drilling without distortion or cracking of the cores. NOTE: Core area may be cooled with dry ice.
3. Determine the density of the cores as per Test Method Nev. T336 and document the results on NDOT form 040-017B.
4. Subtract the drilled core density from the corresponding nuclear density reading and discard the two cores with the biggest difference between the core density and the nuclear density.

<u>EX.</u>	<u>Core Density</u>	<u>Nuclear Density</u>	<u>Difference</u>
1-PM-1	142.3	140.9	1.4
1-PM-2	141.9	142.7	-0.8
1-PM-3	141.1	141.1	-0.0
1-PM-4	144.0	144.4	-0.4
1-PM-5	142.2	142.2	0.0
1-PM-6	140.6	140.4	0.2
1-PM-7	145.1	147.9	-2.8

The biggest difference would be 1-PM-1 and 1-PM-7. Use cores 1-PM-2 through 1-PM-6 for the gauge correlation, to achieve the most consistent correlation.

5. The average of five (5) drilled core densities will be correlated with the average of the five (5) nuclear densities taken at the same location as follows:
- a. If the difference between the two averages is less than $\pm 1\%$ of the average core density, the nuclear gauge readings shall be used without a correction factor.

EX. Core Density Average \times 0.01 = $\pm 1\%$ of Core Density Average

$$147.7 \quad \times \quad 0.01 \quad = \quad 1.477$$

Core Density Average - Nuclear Density Average = Difference

$$147.7 \quad - \quad 147.4 \quad = \quad 0.3$$

The difference is less than 1.477; therefore there will not be a correction factor for this gauge correlation. (EX. Correction factor = 1.00)

- b. If the difference between the two averages exceeds the $\pm 1\%$ of the average core density, a correction factor for the thin layer density gauge shall be determined as follows:

EX. Core Density Average \times 0.01 = $\pm 1\%$ of Core Density Average

$$153.3 \quad \times \quad 0.01 \quad = \quad 1.533$$

Core Density Average - Nuclear Density Average = Difference

$$153.3 \quad - \quad 149.4 \quad = \quad 3.9$$

The difference is greater than the 1.533; therefore there will be a correction factor for this gauge correlation.

$$\frac{\text{Average of the five (5) core densities}}{\text{Average of the five (5) nuclear densities}} = \text{Correction Factor}$$

$$153.3 / 149.4 = 1.03$$

The correction factor is then multiplied by the average density on NDOT form 040-017, to obtain the corrected density. Use this correction factor for all future tests until another correlation is performed.

NOTES PERTAINING TO CORRELATION WITH DRILLED CORES

1. Allow core area to cool prior to coring so the cores do not break or become distorted during coring.
2. Take seven (7) core densities and seven (7) nuclear densities in one test section for the gauge correlation procedure. Obtain a core from each location for a total of seven (7) cores. Refer to Test Method Nev. T336 to determine each samples Bulk Specific Gravity

3. Thin layer density gauge correlation shall be documented on NDOT forms 040-017, 040-017A and 040-017B.
4. Correction Factor's shall be reported to the nearest 0.01.
5. Typically the correction factor should be within 0.96 to 1.04. If you are outside this range contact the Independence Assurance Lab for assistance.
6. The only time a gauge correlation should be labeled "informational tests" is if the correlation took place out of the contracts paving limits, then it will be labeled I1-PM-1 to I1-Pm-7 (EX. Paving a frontage dirt road, correlated on another contract etc.) document where the paving took place under remarks on NDOT form 040-017.
7. The gauge correlation section will be the only test section that has seven (7) tests for the test section, 1-PM-1 to 1-PM-7, each test section that follows will have five (5) tests for the test section, 2-PM-1 to 2-PM-5, unless the gauge has to re-correlated then there will be another test section with seven (7) tests for the test section.
7. Re-correlate the gauge if the mix design changes, percent compaction decreases or increases drastically with no changes to the rolling pattern, when paving on different surfaces or lifts.
8. Refer to the PROCEDURE section to obtain the random numbers used for the thin layer density gauge correlation with the cores. In two of the subsections two additional shots shall be taken with two additional cores to obtain the seven drilled cores for the thin layer density gauge correlation.

PROCEDURE (3450 or 4640-B SERIES GAUGES)

1. Determine the target density per Test Method Nev. T324 or T750 and program it into the thin layer density gauge. After completion of the desired roller coverage, while the mix is still hot, a series of density tests are taken at locations according to the following:
2. Test Sections
 - a. Divide the test section into five subsections of equal length. Four one minute mat density tests are to be taken for each subsection. If a joint or joints are present, two or four one minute joint density tests are to be taken. Refer to the Standard Specifications for the required size of the test sections.

The exact station at which the mat densities will be taken, is determined from the table of random numbers by multiplying a random number (column A) times the length of each subsection, rounded to the nearest 10 m (25 ft).

The exact distance in from the edge of the mat where the mat densities will be taken is determined from the table of random numbers (column B) times the width of the mat, rounded to the nearest 0.3 m (1 ft) for the distance in from the edge. NOTE: Do not take the mat density test any closer than 0.3 m (1 ft) from the edge of the mat.

The first four (4) one minute tests (rotated 90 degrees about the center of the thin layer density gauge) are to be taken in each subsection. If the mat was inlaid, perform two (2) one minute joint tests on each joint within 0.15 m (6 in.) of the joint (rotated 180 degrees) at the same station as determined in column A.

- b. Random numbers are always used in a series of ten, five from column A and five from column B. Any random number block may be used as long as a different block is selected for each new test section.

EX. Random Number Block = 15 Width of the entire mat = 13.8 ft
 Beginning Station "X" 413 + 12 Ending Station "X" 350 + 95

Note: One station equals 100 ft

$$(\text{"X"} 413 + 12) - (\text{"X"} 350 + 95) = 6217 \text{ ft}$$

$$6217 \text{ ft (length of test section)} / 5 \text{ (total subsections)} = 1243.4 \text{ ft (length of each subsection)}$$

Station – Length of Subsection = Station to Station for each Subsection

$$\begin{aligned} (\text{"X"}413 + 12) - 1243.4 &= \text{"X"}400 + 68.6 \\ (\text{"X"} 400 + 68.6) - 1243.4 &= \text{"X"} 388 + 25.2 \\ (\text{"X"} 388 + 25.2) - 1243.4 &= \text{"X"} 375 + 81.8 \\ (\text{"X"} 375 + 81.8) - 1243.4 &= \text{"X"} 363 + 38.4 \\ (\text{"X"} 363 + 38.4) - 1243.4 &= \text{"X"} 350 + 95 \end{aligned}$$

Column A x Subsection Length = Distance for each Subsection Test Station

.698	1243.4	867.9
.796	1243.4	989.7
.348	1243.4	432.7
.358	1243.4	445.1
.698	1243.4	867.9

$$\begin{aligned} (\text{"X"}413+12) - 867.9 &= \text{"X"}404+44.1 \text{ rounded to nearest 10 m (25 ft)} = \text{"X"}404+50 \\ (\text{"X"}400+68.6) - 989.7 &= \text{"X"}390+78.9 \text{ rounded to nearest 10 m (25 ft)} = \text{"X"}390+75 \\ (\text{"X"}388+25.2) - 432.7 &= \text{"X"}383+92.5 \text{ rounded to nearest 10 m (25 ft)} = \text{"X"}384+00 \\ (\text{"X"}375+81.8) - 445.1 &= \text{"X"}371+36.7 \text{ rounded to nearest 10 m (25 ft)} = \text{"X"}371+25 \\ (\text{"X"}363+38.4) - 867.9 &= \text{"X"}354+70.5 \text{ rounded to nearest 10 m (25 ft)} = \text{"X"}354+75 \end{aligned}$$

Column B x Mat Width = Distance in from edge of Mat = Rounded to nearest .5 m (1 ft)

.683	13.8	9.4	9.0
.996	13.8	13.7	13.0 (mat is only 13.8)
.743	13.8	10.3	10.0
.595	13.8	8.2	8.0
.539	13.8	7.4	7.0

1st density test is at "X" 404 + 50, 9.0 ft in from edge of mat
 2nd density test is at "X" 390 + 75, 13.0 ft in from edge of mat
 3rd density test is at "X" 384 + 00, 10.0 ft in from edge of mat
 4th density test is at "X" 371 + 25, 8.0 ft in from edge of mat
 5th density test is at "X" 354 + 75, 7.0 ft in from edge of mat

3. Density Testing

- a. Program the target density from Test Method Nev. T324 or T750 into the thin layer density gauge. Input the target density for the Marshall and Voidless parameters into the thin layer density gauge. Select the “MA/VOIDLESS” key. The screen will display “MA: XXX.X pcf VD: XXX.X Do you want to change?” Press the “YES” key. Screen will display “Marshall XXX.X pcf ” Input the target density and press the “START/ENTER” key. Screen will display “Voidless Density XXX.X pcf.” Input the same target density and press the “START/ENTER” key. Thin layer density gauge will then go back to the main screen.
- b. Select the proper depth by pressing the “THICK” key. The screen will display “Layer Thickness: X.XX in. Input and Press Enter.” NOTE: Set the depth for the thin layer density gauge at 6 mm (0.25 in.) less than what is being placed. (EX. Paving 3 in. set the thin layer density gauge thickness at 2.75 in.) Thin layer density gauge will then go back to the main screen.
- c. Set the count time for 1 minute by pressing the “TIME” key. The screen will show “Count Time XX min. Do you want to change?” Press the “YES” key. The screen will show “Sel: 1 – 0.5 min. 2 – 1 min. 3 – 2 min. 4 – 4 min.” Press 2 for the 1 minute count time. Thin layer density gauge will then go back to the main screen. The 1 minute test is the only “TIME” allowed for density testing.
- d. Do not utilize the “Average” function, verify that the average function is set at 1. The average of the 4 tests shall be hand calculated.
- e. At each predetermined test site, place the thin layer density gauge on the mat. Check for rocking by placing a hand on opposite corners of the base. Outline the base of the thin layer density gauge with a piece of keil (lumber crayon). Place the source rod in the “Measure” position and press the “START/ENTER” key. At the end of the 1 minute count time the thin layer density gauge will display “Dens: X.X PCF %MA: X.XX% 100 - %MA: XX.XX% %VOID: X.XX”. Write the density down on NDOT form 040-017, rotate the thin layer density gauge 90 degrees about the center of the thin layer density gauge and take another one minute density test at this location, refer to Figure 1 for thin layer density gauge positioning. Repeat this procedure for four (4), one minute density tests at this one test location.
- f. Record each one minute density test and hand calculate the average of the four (4) tests on NDOT form 040-017. NOTE: Do NOT use the average mode in the thin layer density gauge.
- g. The average of the four (4) density tests will constitute one test site density.
- h. Repeat the above process at each of the 5 predetermined test site locations within the test section.

4. Joint Density Testing

- a. Place the thin layer density gauge on the mat directly adjacent (within 6 in.) and parallel to the joint line at the same station that the four (4) one minute density tests were taken. Align one edge of the thin layer density gauge along the mat seam. The thin layer density gauge should be firmly seated on the new HOT mat and located as close to the joint as possible without extending any part of

the gauge beyond the seam. Put the probe in the “Measure” position and press the “START/ENTER” key. At the end of the 1 minute count time the thin layer density gauge will display “Dens: X.X PCF %MA: X.XX% 100 - %MA: XX.XX% %VOID: X.XX.” Write the joint density down on NDOT form 040-017. Take two (2) one minute density readings on the joint, rotating the gauge 180 degrees about its center after each reading, refer to Figure 1 for thin layer density gauge positioning. If the mat has been inlaid, it will require joint measurements on each HOT side of the mat.

- b. Record each one minute joint density test and hand calculate the average of the two (2) tests on NDOT form 040-017.
- c. The average of the readings for each individual joint (two one minute tests), will constitute one test site joint density.
- d. Joint density tests will not be required on unconfined edges. Joint density tests are completed on the hot side of the mat.

PERCENT COMPACTION

1. Percent relative compaction of an individual test site or small test section:
 - a.
$$\% \text{ Relative Compaction} = \frac{((\text{Average Density}) \text{ or } (\text{Corrected Density})) \times (\text{Correction Factor})}{\text{Target Density}}$$
 - b. Record the percent relative compaction to the nearest whole percent.
2. Take the average of the five (5) corrected densities (Mean Test Section Density) and compute the Mean Percent Relative Compaction as follows:
 - a.
$$\text{Mean Percent Relative Compaction} = \frac{\text{Mean Test Section Density}}{\text{Target Density}}$$
 - b. Record the percent compaction to the nearest whole percent.
3. Refer to Standard Specifications for the minimum and maximum density requirements.
Note: Do not incorporate joint densities when calculating the Mean Test Section Density

ADDITIONAL ROLLING PROCEDURES

1. If an individual test either on the mat or on a joint does not meet the required minimum specifications for compaction, additional rolling may be required. After additional rolling, take another test by testing at a single location chosen at random within the same subsection. (This is not considered a re-test, since there are no re-tests on plantmix. The second test will be the one documented for the complete test section.) Note: Any changes from the original compaction must be documented under remarks.

2. If the mean test section compaction for the mat does not meet the required minimum specifications for compaction, additional rolling may be required on the entire test section. After additional rolling, take a series of five (5) tests using a new random block number, see Figure 2. (This is not considered a re-test, since there are no re-tests on plantmix). Note: Any changes from the original compaction must be documented under remarks.
3. No additional rolling will be performed if the surface temperature of the lift is below 68°C (155°F).
4. If additional compactive effort still results in a failing test, joint test or test section, the Resident Engineer must indicate under the remarks on NDOT form 040-017 what necessary steps are to take place if any pertaining to the failure in question.

GENERAL:

1. Under no circumstance is the thin layer density gauge (Troxler Model 4640-B) to be used for testing the compaction of concrete or dirt.
2. Do not leave the gauge on the hot plantmix surface any longer than absolutely necessary when taking the four, one minute counts. Long term exposure to high temperatures will reduce the service life of the components and temporarily effect the accuracy of the gauge.
3. If there is more than 1000 m² (1000 yd²) (small section or miscellaneous test) of the mat to be tested it shall be made into a full test section even if it's less than the 5500 m² (6600 yd²). There shall not be multiple small sections tested in a row. If paving approaches note that it is an approach under remarks.
4. The small sized area of 90% compaction per the Standard Specifications is not meant for mainline paving.
5. The mean percent relative compaction from NDOT form 040-017 is NOT applicable to partial test sections or joint densities.
6. For all coarses of 25 mm (1 in.) or less, use "Method A" from the Standard Specifications. No compactions per "Method B" shall be required since the thin layer density gauge detects underlying material for lifts of 25 mm (1 in.) or less.



Thin layer density gauge positioning for one density test location.



Thin layer density gauge positioning for one joint density test location.

FIGURE 1

**TABLE OF
 RANDOM NUMBERS**

A	B	A	B	A	B	A	B	A	B
1		2		3		4		5	
.576	.730	.430	.754	.271	.870	.732	.721	.998	.239
.892	.948	.858	.025	.935	.114	.153	.508	.749	.291
.669	.726	.501	.402	.231	.305	.009	.420	.517	.858
.609	.482	.809	.140	.396	.025	.937	.310	.253	.761
.971	.824	.902	.470	.997	.392	.892	.957	.640	.463
6		7		8		9		10	
.053	.899	.554	.627	.427	.760	.470	.040	.904	.993
.810	.159	.225	.163	.549	.405	.285	.542	.231	.919
.081	.277	.035	.039	.860	.507	.081	.538	.986	.501
.982	.468	.334	.921	.690	.806	.879	.414	.106	.031
.095	.801	.576	.417	.251	.884	.522	.235	.398	.222
11		12		13		14		15	
.509	.025	.794	.850	.917	.887	.751	.608	.698	.683
.371	.059	.164	.838	.289	.169	.569	.977	.796	.996
.165	.996	.356	.375	.654	.939	.815	.592	.348	.743
.477	.535	.337	.155	.767	.187	.579	.787	.358	.595
.788	.101	.434	.638	.021	.894	.324	.871	.698	.539
16		17		18		19		20	
.566	.815	.622	.548	.947	.169	.317	.472	.864	.466
.901	.342	.873	.964	.942	.985	.123	.086	.335	.212
.470	.682	.412	.064	.150	.962	.925	.355	.909	.019
.068	.242	.667	.356	.195	.313	.396	.460	.740	.247
.874	.420	.127	.284	.448	.215	.833	.652	.601	.326
21		22		23		24		25	
.897	.877	.209	.862	.428	.117	.100	.259	.425	.284
.875	.969	.109	.843	.759	.239	.890	.317	.428	.802
.190	.696	.757	.283	.666	.491	.523	.665	.919	.146
.341	.688	.587	.908	.865	.333	.928	.404	.892	.696
.846	.355	.831	.218	.945	.364	.673	.305	.195	.887
26		27		28		29		30	
.882	.227	.552	.077	.454	.731	.716	.265	.058	.075
.464	.658	.629	.269	.069	.998	.917	.217	.220	.659
.123	.791	.503	.447	.659	.463	.994	.307	.631	.422
.116	.120	.721	.137	.263	.176	.798	.879	.432	.391
.836	.206	.914	.574	.870	.390	.104	.755	.082	.939
31		32		33		34		35	
.636	.195	.614	.486	.629	.663	.619	.007	.296	.456
.630	.673	.665	.666	.399	.592	.441	.649	.270	.612
.804	.112	.331	.606	.551	.928	.830	.841	.602	.183
.360	.193	.181	.399	.564	.772	.890	.062	.919	.875
.183	.651	.157	.150	.800	.875	.205	.446	.648	.685

FIGURE 2

State of Nevada
Department of Transportation
Materials Division

**METHOD OF TEST FOR BULK SPECIFIC GRAVITY AND DENSITY OF COMPACTED
BITUMINOUS MIXTURES (FIELD METHOD)**

SCOPE

This test method covers a rapid determination of bulk specific gravity and density of specimens of compacted bituminous mixtures. It will be used for drilled cores obtained from the field.

APPARATUS

1. Balance, 2000 g minimum capacity, sensitive to 0.1 g. Equipped with suitable suspension rod and holder to permit weighing of a specimen while suspended from the center of the balance pan into a water container.
2. Water container, for immersing the specimen in water while suspended under the balance. A 500 mm (20 in.) diameter watertight (plastic) garbage can, approximately 600 mm (24 in.) high is recommended.
3. Thermometer, for monitoring water and specimen temperatures, accurate to 1°C (2°F).
4. Oven, capable of maintaining a temperature of $110 \pm 5^\circ\text{C}$ ($230 \pm 9^\circ\text{F}$).
5. Microwave oven.
6. Water Bath, minimum 20 L (5 gal) maintained at $25 \pm 3^\circ\text{C}$ ($77 \pm 5^\circ\text{F}$).
7. Bench or table to support balance over water bath.
8. Wire basket with handle.
9. Towel

TEST SPECIMENS

1. Test specimens are to be drilled cores taken from the bituminous pavement mat.
2. Size of specimens – Core size shall be 100 mm (4 in.) in diameter. Thickness shall be as close to plan as possible or greater.

3. Pavement specimens shall be taken from bituminous pavement with a core drill taking care to avoid distortion, bending or cracking of specimens during and after removal from the pavement.
4. Specimens shall be free from foreign materials such as tack coat, seal coat, soil, etc.
5. Specimens may be separated from other pavement layers by sawing, chiseling, or other suitable means.

PROCEDURE

1. Maintain the water temperature at $25 \pm 3^{\circ}\text{C}$ ($77 \pm 5^{\circ}\text{F}$). While the wire basket is immersed in the water, adjust the water level until water flows from the overflow spout, allow water and basket to stabilize and tare the immersed basket. Place specimen in the wire basket, leave immersed in the water container for four minutes and record the immersed in water weight, "C" on NDOT form 040-017B.
2. Remove specimen from the water and bring it to a saturated surface dry condition by blotting the sample with a damp towel, determine the weight of the sample and record it as "B" on NDOT form 040-017B.
3. Place specimen in a large flat bottom drying pan (conventional oven); may also use paper plate, glass dish or ceramic dish (microwave oven). For microwave oven use, refer to Test Method Nev. T306. For conventional oven drying use, refer to Test Method Nev. T112. Place the specimen in conventional oven or microwave oven. Leave the specimen in the conventional oven or heat in microwave oven until it can be easily broken down. Place the separated specimen in the conventional oven or microwave oven and dry to a constant weight. When a constant dry weight is obtained, allow the sample to cool to $25 \pm 3^{\circ}\text{C}$ ($77 \pm 5^{\circ}\text{F}$), weigh and record the oven-dry condition weight, "A" on NDOT form 040-017B.

CALCULATIONS

1. Calculate the Bulk Specific Gravity as follows:

$$\text{Bulk S.G.} = \frac{A}{B - C} \quad \text{where} \quad \begin{array}{l} A = \text{Weight in grams in air (oven-dry condition)} \\ B = \text{Weight in grams (saturated surface-dry)} \\ C = \text{Weight in grams (immersed in water)} \end{array}$$

2. Core Density (lb/ft^3) = Bulk Specific Gravity x $62.4 \text{ lbs}/\text{ft}^3$. Round to the nearest 0.1.
3. Nuclear density obtained from the Average Density of the four (4) density readings from NDOT form 040-017.
4. Subtract the core density from the nuclear density to determine the difference of the two. Discard the two cores with the biggest difference between the core density and the nuclear density. Use five cores that are the most uniform, to obtain the "AVERAGE OF THE FIVE (5) CORES", report the bulk specific gravity, core density, and nuclear density on NDOT form 040-017A.

PRECAUTIONS

1. Maintain a constant water level for all weights obtained in the water bath
2. Do not overheat or burn samples. Note: If the sample is smoking the specimen has been burned.
3. To obtain the SSD condition, do not use paper towels to blot the specimen dry, paper towels will absorb too much moisture, affecting the SSD weight
4. Use the same scale for all weight measurements
5. Make sure the suspension apparatus is not in contact with the hole in the counter nor any other obstructions exist

REPORT

Bulk Specific Gravity to nearest 0.001

Core Density to the nearest 0.001 Mg/m^3 (0.1 lb/ft^3)

Nuclear Density to the nearest 0.001 Mg/m^3 (0.1 lb/ft^3)

State of Nevada
Department of Transportation
Materials Division

**METHOD OF TEST FOR SAMPLING, DETERMINING UNIT WEIGHT, AIR CONTENT, AND
MAKING AND CURING SPECIMENS OF HYDRAULIC-CEMENT
SELF-CONSOLIDATING CONCRETE**

SCOPE

This test method covers the procedure for obtaining representative samples of hydraulic-cement self-consolidating concrete from approved delivery equipment and modifications to procedures for determining unit weight, air content, and making and curing specimens of self-consolidating concrete (SCC).

SAMPLING

Sampling of freshly mixed SCC shall be performed in accordance with Test Method Nev. T425, except the time to obtain the representative sample shall not exceed 2 minutes.

UNIT WEIGHT, AIR CONTENT, AND MAKING AND CURING SCC SPECIMENS

1. The unit weight test shall be performed in accordance with Test Method Nev. T435, except the measure shall be filled in one lift without vibrating, rodding or tamping.
2. The air content test shall be performed in accordance with Test Method Nev. T431 or T432, except the bowl shall be filled in one lift without vibrating, rodding, or tamping.
3. Compressive strength and segregation test specimens shall be made in accordance with Test Method Nev. T428, except the specimen molds shall be filled in one lift without vibrating, rodding or tamping.

State of Nevada
Department of Transportation
Materials Division

**METHOD OF TEST FOR UNOBSTRUCTED SLUMP FLOW AND STABILITY OF
HYDRAULIC-CEMENT SELF-CONSOLIDATING CONCRETE**

SCOPE

This test method covers the determination of the flow-ability and stability of fresh hydraulic-cement self-consolidating concrete using the slump cone. The average diameter of the unobstructed slump flow is a measure of the filling ability (flow-ability) of self-consolidating concrete (SCC). The Visual Stability Index (VSI) is a measure of the dynamic segregation resistance (stability) of SCC.

APPARATUS

1. Slump cone mold and tamping rod, shall conform to Test Method Nev. T438.
2. Base plate, smooth, rigid, nonabsorbent sealed or laminated plywood, rigid plastic or steel, and be at least 914 mm (36 in.) in diameter.
3. Trowel and hand scoop.
4. Measuring tape, having a minimum graduation of 10 mm (0.5 in.).
5. Stopwatch, accurate to the nearest .01 second.

SAMPLING

Sampling shall be performed in accordance with Test Method Nev. T416.

PROCEDURE

1. Place the base plate on level, stable ground. Dampen the slump cone mold and base plate. Wipe away any excess water with a moist cloth or damp sponge.
2. Center the slump cone mold on the base plate. The slump cone mold shall be placed with the smaller diameter opening facing down (See Figure 1).
3. Using a hand scoop, fill the slump cone mold in one lift without vibrating, rodding or tamping.

4. Strike off the surface of the concrete, level with the top of the slump cone mold using a trowel or by means of a screeding or rolling motion using a tamping rod. Remove excess concrete from around the base of the slump cone mold and base plate.
5. Raise the slump cone mold in a vertical direction, making sure the mold clears the top of the SCC in 3 ± 1 second without any lateral or torsional motion. Complete the test procedure from filling the slump cone mold to removal of the slump cone mold, without any interruption, and within 2.5 minutes.
6. *If specified in the contract documents:* From the time the slump cone mold is lifted, measure the time in seconds it takes for the concrete to reach a diameter of 500 mm (20 in.). This is the T_{50} time.
7. When the concrete has stopped flowing measure the maximum diameter of the resulting unobstructed slump flow and then measure the diameter perpendicular to the maximum diameter. If the difference between the two unobstructed slump flow diameters is more than 50 mm (2 in.), the test is invalid. Check to make sure the base plate is level and flat, and run the test again ensuring that the slump cone is raised in a vertical direction within 3 ± 1 seconds.

Example: 560 mm (22 in.) unobstructed slump flow – 510 mm (20 in.) unobstructed slump flow = 50 mm (2 in.), test is acceptable.

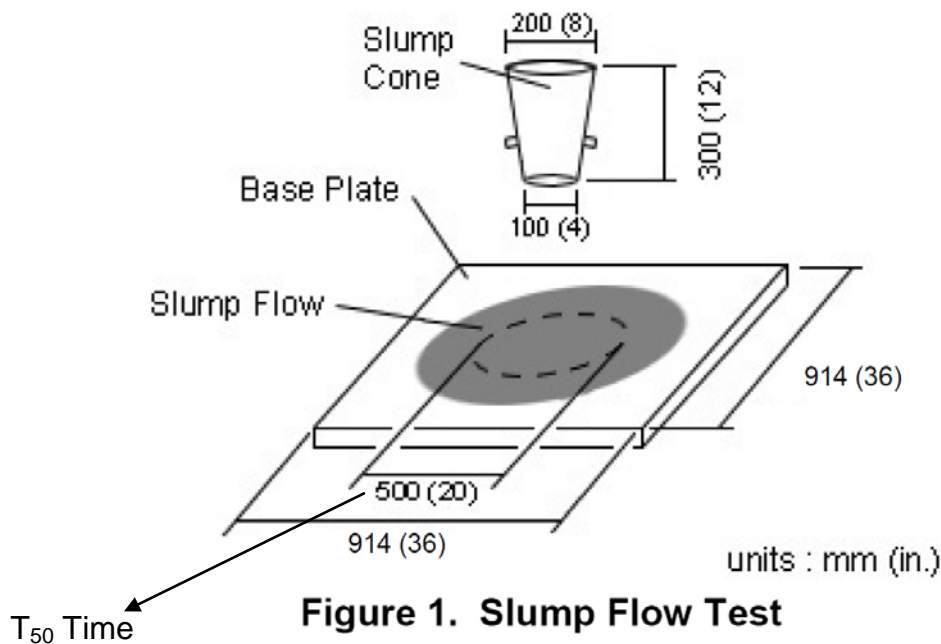

CALCULATIONS

Calculate the average of the two measured diameters. This is the slump flow.

Example: 560 mm (22 in.) unobstructed slump flow + 510 mm (20 in.) unobstructed slump flow =
1070 mm (42 in.) / 2 = 535 mm (21 in.) = 530 mm (21 in.) unobstructed slump flow.

By visual examination, rate the Visual Stability Index (VSI) of the SCC using the criteria in Table 1 and photo illustrations shown in Figures 2 - 9.

Table 1 - Visual Stability Index (VSI) Rating Criteria

Rating	Criteria
0 Stable	No evidence of segregation or bleeding in slump flow area, mixer drum chute, or sampling receptacle (e.g. wheelbarrow, bucket, etc.)
1 Stable	No mortar halo or coarse aggregate heaping within the slump flow area, but slight bleeding and/or air popping is evident on the surface of the slump flow area on the concrete surface in the mixer drum chute or sampling receptacle.
2 Unstable	Slight mortar halo, # 10 mm (0.5 in.) wide within slump flow area, and/or coarse aggregate heaping in the slump flow area, and highly noticeable bleeding in the mixer drum chute or sampling receptacle.
3 Unstable	Clearly segregated by evidence of a large mortar halo, > 10 mm (0.5 in.) wide, and/or large coarse aggregate pile with the slump flow area. A thick layer of paste on the concrete surface in the mixer drum chute or sampling receptacle.

REPORT

1. Report the unobstructed slump flow to the nearest 10 mm (0.5 in.).
2. Report the VSI rating.
3. *If specified in the contract documents:* Report the T₅₀ time to the nearest 0.2 seconds.

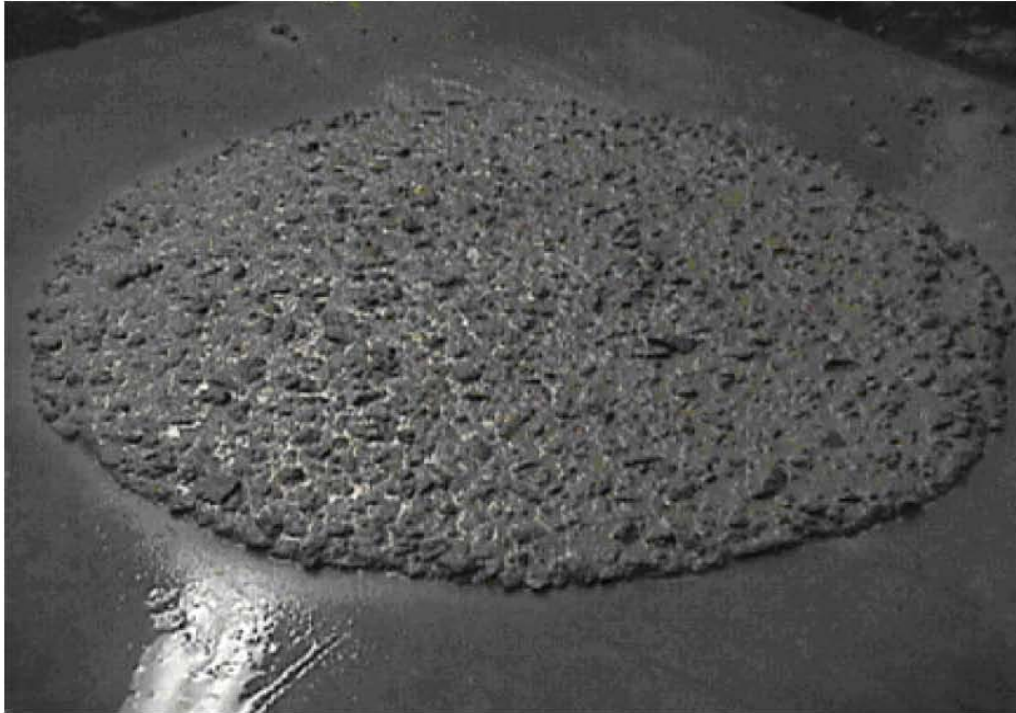

Figure 2. VSI = 0, stable

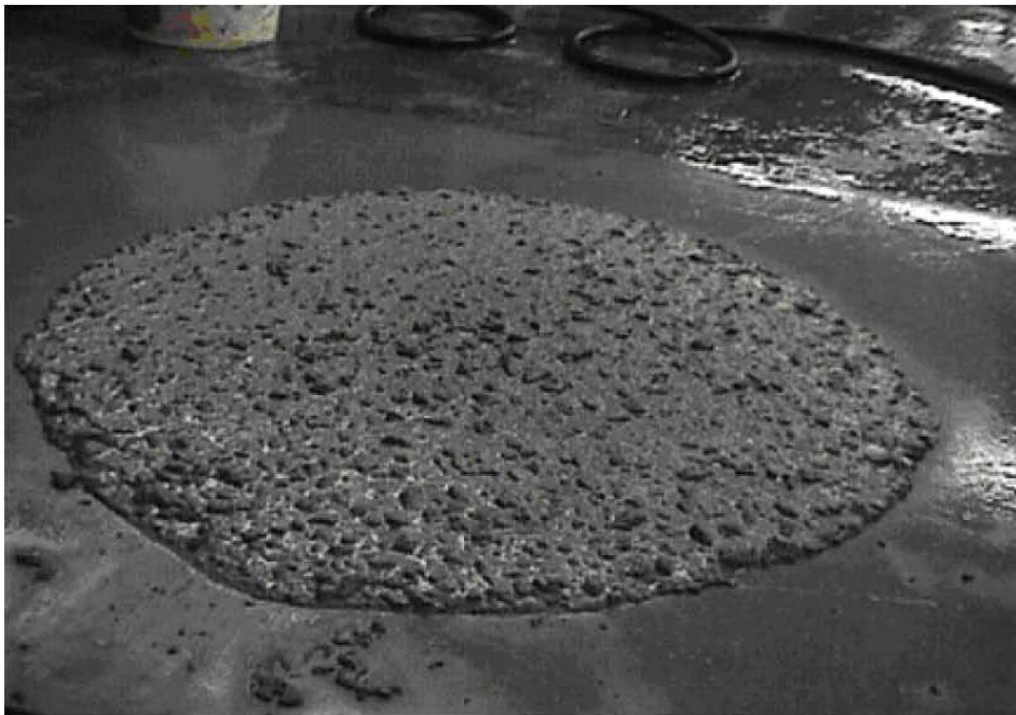

Figure 3. VSI = 0, stable



Figure 4. VSI = 1, stable



Figure 5. VSI = 1, stable



Figure 6. VSI = 2, unstable



Figure 7. VSI = 2, unstable



Figure 8. VSI = 3, unstable

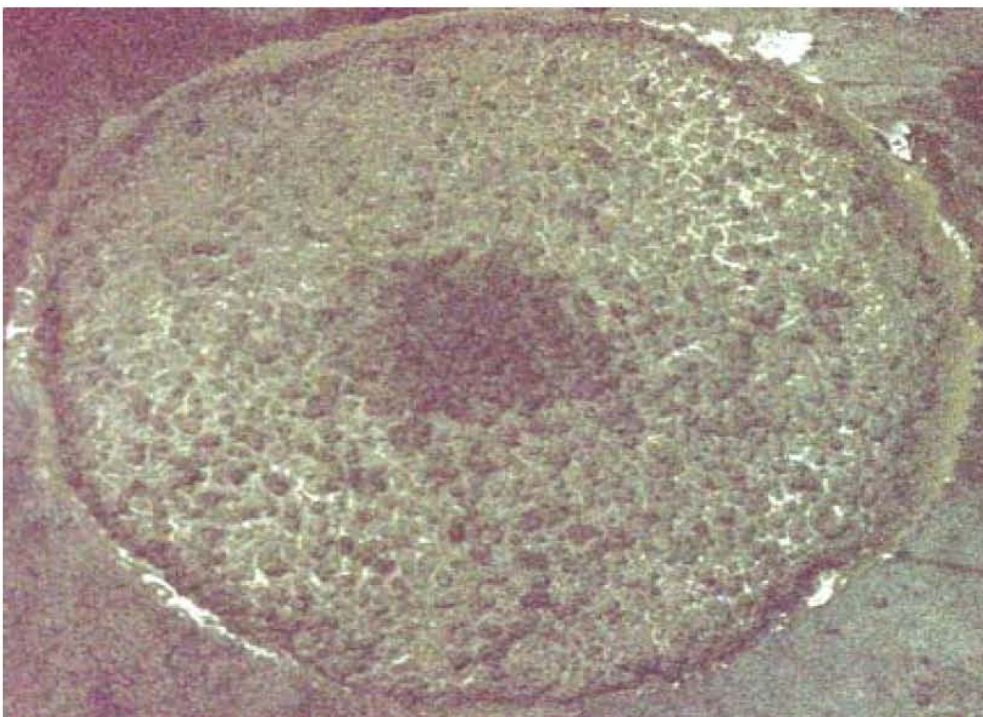

Figure 9. VSI = 3, unstable

State of Nevada
Department of Transportation
Materials Division

**METHOD OF TEST FOR PASSING ABILITY OF HYDRAULIC-CEMENT
SELF-CONSOLIDATING CONCRETE BY J-RING AND SLUMP CONE**

SCOPE

This test method covers the determination of the flow-ability and stability of fresh hydraulic-cement self-consolidating concrete using the j-ring and slump cone. The diameter of the unobstructed slump flow versus the obstructed slump flow passing through the j-ring, is a measure of the j-ring value and the passing ability rating of self-consolidating concrete (SCC).

APPARATUS

1. J-Ring, with smooth bars (See Figure 1).
2. Slump cone mold and tamping rod, shall conform to Test Method Nev. T438.
3. Base plate, smooth, rigid, nonabsorbent sealed or laminated plywood, rigid plastic or steel, and be at least 914 mm (36 in.) in diameter.
4. Trowel and hand scoop.
5. Measuring tape, have a minimum graduation of 10 mm (0.5 in.).

SAMPLING

Sampling shall be performed in accordance with Test Method Nev. T416.

PROCEDURE

1. Place the base plate on level, stable ground. Dampen the j-ring, slump cone mold and base plate. Wipe away any excess water with a moist cloth or damp sponge.
2. Center the j-ring on the base plate. The slump cone mold shall be centered within the j-ring with the smaller diameter opening facing down (See Figure 2).
3. Using a hand scoop, fill the slump cone mold in one lift without vibrating, rodding or tamping.

4. Strike off the surface of the concrete, level with the top of the slump cone mold using a trowel or by means of a screeding or rolling motion using a tamping rod. Remove excess concrete from around the base of the slump cone mold and base plate.
5. Raise the slump cone mold in a vertical direction, making sure the mold clears the j-ring in 3 ± 1 second without any lateral or torsional motion. Complete the test procedure from filling the slump cone mold to removal of the slump cone mold, without any interruption, and within 2.5 minutes.

When the concrete has stopped flowing, with the j-ring still in place measure the maximum diameter of the resulting obstructed slump flow and then measure the diameter perpendicular to the maximum diameter. If the difference between the two obstructed slump flow diameters is more than 50 mm (2 in.), the test is invalid. Check to make sure the base plate is level and flat, and run the test again ensuring that the slump cone is raised in a vertical direction within 3 ± 1 seconds.

CALCULATIONS

1. Calculate the average of the two measured diameters. This is the j-ring flow.

Example: $560 \text{ mm (22 in.)} + 530 \text{ mm (21 in.)} = 1090 \text{ mm (43 in.)}$
 $1090 \text{ mm (43 in.)} / 2 = 546 \text{ mm (21.5 in.)} = 550 \text{ mm (21.5 in.) j-ring flow}$

2. Calculate the difference between the unobstructed slump flow (determined per Test Method Nev. T417) and the j-ring flow, of the same representative sample. This is the j-ring value. Rate the Passing Ability of SCC using the criteria in Table 1.

Example: $535 \text{ mm (21 in.) unobstructed slump flow} - 510 \text{ mm (20 in.) j-ring flow} = 25 \text{ mm (1 in.) j-ring value}$

Table 1 - Passing Ability Rating

<u>J-Ring Value</u>	<u>Passing Ability Rating</u>	<u>Remarks</u>
0 to 25 mm (0 to 1 in.)	0	High passing ability
> 25 to 50 mm (> 1 to 2 in.)	1	Moderate passing ability
> 50 mm (> 2 in.)	2	Low passing ability

Example: $25 \text{ mm (1 in.) j-ring value} = 0 \text{ (Passing Ability Rating)} = \text{High Passing Ability}$

REPORT

1. Report the j-ring flow and j-ring value to the nearest 10 mm (0.5 in.).
2. Report the j-ring flow value and corresponding passing ability rating on NDOT form 040-056.

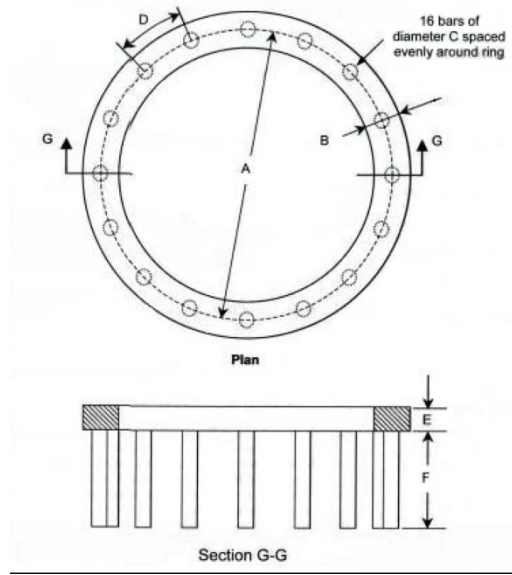

<u>Dimension</u>	<u>mm</u>	<u>in.</u>
A	300 ± 3.3	12.0 ± 0.13
B	38 ± 1.5	1.5 ± 0.06
C	16 ± 3.3	0.625 ± 0.13
D	58.9 ± 1.5	2.36 ± 0.06
E	25 ± 1.5	1.0 ± 0.06
F	100 ± 1.5	4.0 ± 0.06

Figure 1. J-Ring

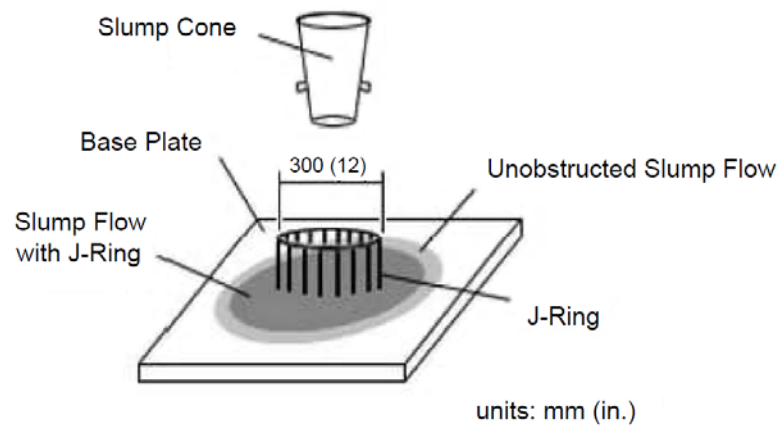

Figure 2. J-Ring Test

State of Nevada
Department of Transportation
Materials Division

METHOD OF TEST FOR SAMPLING FRESH CONCRETE

SCOPE

This test method covers the procedure for obtaining representative samples of fresh concrete as delivered to the project site, from stationary, paving and truck mixers, agitating and non-agitating equipment, or dump trucks.

SIZE OF SAMPLE

Make the sample size to be used for strength tests and unit weight tests a minimum of 0.028 m³ (1 ft³). Smaller samples may be permitted for routine temperature, slump test and air content.

SAMPLING CONCRETE USING RANDOM NUMBERS

Samples of concrete for test specimens shall be taken in accordance with the following:

When the testing frequency is based on volume, the location to be sampled shall be determined by the use of the Table of Random Numbers given in Figure 1. This method depends upon the volume of the material the sample represents and the capacity of the delivery vehicle. The vehicle to be sampled is determined by the following procedure:

From the table of random numbers select a number block 1 thru 35. Do not use the same number more than once per day. Multiply the random number by the volume of the material the sample will represent. Then divide the volume obtained by the volume of one delivery vehicle. This number will represent the vehicle to be sampled. Use standard practice for rounding off, unless the random number selected indicates the unit to be sampled to be less than one. Then the unit to be sampled will be considered to be number one.

Example: Sampling concrete using Ready mix delivery vehicles. Using random number block 1, column B, and random number .482. The sample frequency is one per 100 yd³. Multiply .482 x 100 yd³ = 48.2 yd³. Ready Mix delivery vehicle's capacity is 10 yd³. Divide 48.2 yd³/10 yd³ = 4.82, 4.82 rounded = 5. Samples would be taken from the 5th ready mix delivery vehicle.

PROCEDURE

1. The elapsed time between obtaining the first and final portions of the composite samples shall be as short as possible, but in no instance shall it exceed 15 minutes.
 - a. Fresh concrete tests such as temperature, slump, air content and unit weight are to be performed as close to the pour site as possible. The transporting of samples for these tests could alter the test results, and should be avoided. Samples for compressive strength cylinders may be transported, if deemed necessary, but must be remixed to ensure uniformity before using.
 - b. Tests for temperature, slump or air content shall be started within 5 minutes after the sampling is complete. These tests should then be completed as expeditiously as possible after the composite sample has been fabricated. Tests for unit weight and cylinders for strength testing must be started within 15 minutes after the sampling is complete. The elapsed time between obtaining and using the sample shall be as short as possible and the sample should be protected from the sun, wind, other sources of rapid evaporation, and from contamination.
2. Sampling should be performed as the concrete is delivered from the mixer to the conveying vehicle used to transport the concrete to the forms; however, specifications may require other points of sampling. The procedures used in sampling shall include the use of every precaution that will assist in obtaining samples that are truly representative of the nature and condition of concrete sampled as follows:
 - a. Sampling from Stationary Mixers (Except Paving Mixers) - Sample the concrete at two or more regularly spaced intervals during discharge of the middle portion of the batch. Take the samples, within the 15 minute time limit and composite them into one sample for test purposes. Do not obtain samples from the very first or last portions of the batch discharge. Perform sampling by passing a receptacle completely through the discharge stream, or by completely diverting the discharge into a sample container. If discharge of the concrete is too rapid to divert the complete discharge stream, discharge the concrete into a container or transportation unit sufficiently large enough to accommodate the entire batch and then accomplish the sampling in the same manner as given above. Take care not to restrict the flow of concrete from the mixer, container or transportation unit so segregation does not occur. These requirements apply to both tilting and nontilting mixers.



- b. Sampling from Stationary Mixers used for portland cement concrete pavement (PCCP) - Sample the fresh concrete after the contents of the mixer have been discharged into the conveying vehicle and moved to the testing platform. Obtain samples from at least five different portions of the batch and composite them into one sample for testing purposes.



- c. Sampling from Paving Mixers - Sample the concrete after the contents of the paving mixer have been discharged. Obtain samples from at least five different portions of the pile and composite them into one sample for test purposes. Avoid contamination with subgrade material or prolonged contact with an absorptive subgrade. To preclude contamination or absorption by the subgrade, sample the concrete by placing five shallow containers on the subgrade and discharging the concrete across the containers. Combine the samples obtained into one composite sample for test purposes. The containers shall be of a size that is in agreement with the maximum aggregate size. In some instances, the containers may have to be supported above the subgrade to prevent displacement during discharge.



- d. Sampling from Revolving Drum Truck Mixers or Agitators - Sample the concrete during discharge of the middle portion of the batch. Repeatedly pass a receptacle through the entire discharge stream or by completely diverting the discharge stream into a sample container. Take the samples obtained within the 15 minute time limit and combine them into one composite sample for test purposes. Do not obtain samples until after all of the water and admixtures have been added to the mixer. Do not obtain samples from the very first or last portions of the batch discharge. Regulate the rate of discharge of the batch by the rate of revolution of the drum and not by the size of the gate opening.



- e. Sampling from Open-top Truck Mixers, Agitators, Nonagitating Equipment, or Other Types of Open-top Containers - Take samples by whichever of the procedures described in a, b, c, or d is most applicable under the given conditions.

TABLE OF
RANDOM NUMBERS

A	B	A	B	A	B	A	B	A	B										
1	.576 .892 .669 .609 .971	2	.730 .948 .726 .482 .824	3	.430 .858 .501 .809 .902	4	.754 .025 .402 .140 .470	5	.271 .935 .231 .396 .997	6	.870 .114 .305 .025 .392	7	.732 .153 .009 .937 .892	8	.721 .508 .420 .310 .957	9	.998 .749 .517 .253 .640	10	.239 .291 .858 .761 .463
6	.053 .810 .081 .982 .095	7	.899 .159 .277 .468 .801	8	.554 .225 .035 .334 .576	9	.627 .163 .039 .921 .417	10	.427 .549 .860 .690 .251	11	.760 .405 .507 .806 .884	12	.470 .285 .081 .879 .522	13	.040 .542 .538 .414 .235	14	.904 .231 .986 .106 .398	15	.993 .919 .501 .031 .222
11	.509 .371 .165 .477 .788	12	.025 .059 .996 .535 .101	13	.794 .164 .356 .337 .434	14	.850 .838 .375 .155 .638	15	.917 .289 .654 .767 .021	16	.887 .169 .939 .187 .894	17	.751 .569 .815 .579 .324	18	.608 .977 .592 .787 .871	19	.698 .796 .348 .358 .698	20	.683 .996 .743 .595 .539
16	.566 .901 .470 .068 .874	17	.815 .342 .682 .242 .420	18	.622 .873 .412 .667 .127	19	.548 .964 .064 .356 .284	20	.947 .942 .150 .195 .448	21	.169 .985 .962 .313 .215	22	.317 .123 .925 .396 .833	23	.472 .086 .355 .460 .652	24	.864 .335 .909 .740 .601	25	.466 .212 .019 .247 .326
21	.897 .875 .190 .341 .846	22	.877 .969 .696 .688 .355	23	.209 .109 .757 .587 .831	24	.862 .843 .283 .908 .218	25	.428 .759 .666 .865 .945	26	.117 .239 .491 .333 .364	27	.100 .890 .523 .928 .673	28	.259 .317 .665 .404 .305	29	.425 .428 .919 .892 .195	30	.284 .802 .146 .696 .887
26	.882 .464 .123 .116 .836	27	.227 .658 .791 .120 .206	28	.552 .629 .503 .721 .914	29	.077 .269 .447 .137 .574	30	.454 .069 .659 .263 .870	31	.731 .998 .463 .176 .390	32	.716 .917 .994 .798 .104	33	.265 .217 .307 .879 .755	34	.058 .220 .631 .432 .082	35	.075 .659 .422 .391 .939
31	.636 .630 .804 .360 .183	32	.195 .673 .112 .193 .651	33	.614 .665 .331 .181 .157	34	.486 .666 .606 .399 .150	35	.629 .399 .551 .564 .800	36	.663 .592 .928 .772 .875	37	.619 .441 .830 .890 .205	38	.007 .649 .841 .062 .446	39	.296 .270 .602 .919 .648	40	.456 .612 .183 .875 .685

Figure 1

State of Nevada
Department of Transportation
Materials Division

**METHOD OF TEST FOR FLOW OF GROUT MIXTURES
(Flow Cone Method)**

SCOPE

This test method covers the procedure, used both in the laboratory and in the field, for determining the flow of grout mixtures by measuring the time of efflux of a specified volume of grout from a standardized flow cone.

APPARATUS

1. Flow Cone, with dimensions as shown in Figure 1. The discharge tube shall be stainless steel. The body can be stainless steel, cast aluminum, or other non-corroding metal.
2. Receiving container, minimum capacity of 2000 mL.
3. Ring stand or other suitable device, capable of supporting the flow cone in a vertical, steady position over the receiving container.
4. Level, carpenter's or similar.
5. Stop watch, accurate to the nearest 0.1 second.
6. Rubber stopper for grout cone.
7. Scale, minimum capacity of 45 kg (100 lb), sensitive to 0.1.

CALIBRATION OF APPARATUS

1. The flow cone shall be firmly mounted in such a manner that the top will be level and the cone free from vibration. The discharge tube shall be closed by placing a rubber stopper from the underneath side into the lower end. A quantity of water equal to 1725 ± 5 mL shall be introduced into the cone to indicate the grout level as per Figure 1. Calibrate the cone in accordance with the manufacturer's recommendation.

SAMPLE

1. The test sample specimen shall consist of 1725 ± 5 mL of grout.

PROCEDURE

Moisten the inside surface of the flow cone. Place rubber stopper into the outlet of the discharge tube. Introduce grout into the cone until the grout surface rises into contact with the grout level as per Figure 1. Start the stopwatch and remove the rubber stopper simultaneously. Stop the stopwatch at the first break in the continuous flow of grout from the discharge tube. The time indicated by the stopwatch is the time of efflux of the grout. At least two tests shall be made for any grout mixture. Results from two properly conducted tests on the same material should not differ by more than 2 ½ seconds.

A recommended procedure for insuring that the interior of the cone is properly dampened, fill the cone with water and, one minute prior to adding the grout sample, allow the water to drain from the cone.

For the specifications on the time of efflux, refer to the Standard Specifications and Special Provisions.

REPORT

On the Daily Construction Report NDOT form 040-056 shall include:

1. Average time of efflux to the nearest 0.2 seconds
2. Temperature of grout sample at the time of test
3. Ambient temperature at the time of test
4. Composition of the sample

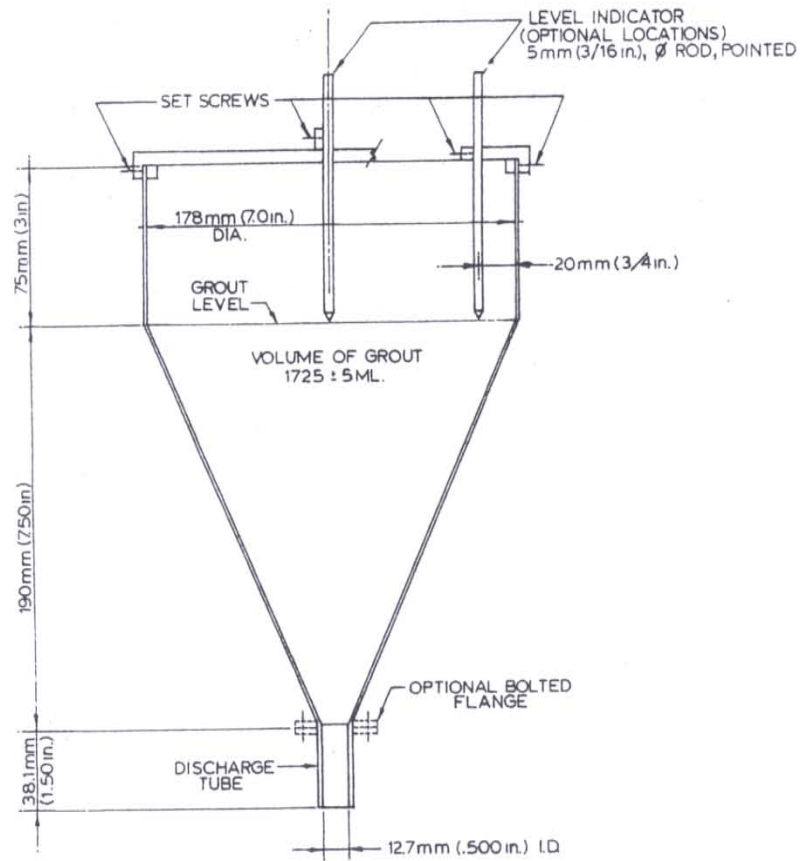

Figure 1 - Cross Section of Flow Cone

State of Nevada
Department of Transportation
Materials Division

**STANDARD METHOD OF TEST FOR MAKING AND CURING
GROUT OR MORTAR COMPRESSION TEST SPECIMENS IN THE FIELD**

SCOPE

This test method covers the procedures for making and curing specimens of masonry grout or mortar in the field for compressive strength tests.

APPARATUS

1. Cylindrical molds, with non-absorbent surfaces, substantial enough to hold their shape during the molding of test specimens. The approved standard mold is 100 mm x 200 mm (4 in. x 8 in.).
2. Mallet, with a rubber or rawhide head weighing 0.60 ± 0.02 kg (1.25 ± 0.50 lb).
3. Shovel, pail, trowel, scoop, etc.
4. Suitable pan, wheelbarrow, or nonabsorbent mixing board of sufficient capacity to allow mixing of the entire sample.

SAMPLING

Obtain a representative sample per Test Method Nev. T425. The item being constructed shall be noted on NDOT form 020-017.

PROCEDURE

1. Specimens shall be molded on a level, rigid surface, free of vibration or other disturbances at a place as close as practicable to the location where they are to be stored. If it is not practicable to mold the specimens where they will be stored, they may be moved to the place of storage immediately after being struck off. All jarring, striking, tilting, or scarring the surface of the completed specimens shall be avoided when moving them to the storage area. Specimens shall be molded on site and brought to the storage place as soon as possible.
2. Thoroughly mix or agitate the grout to obtain a fully representative mix and place into a 4 in. x 8 in. mold using a scoop.

3. Grout/Mortar without coarse aggregate; fill the mold in one lift and tap the sides of the mold by hand or with the mallet, 10 – 15 times to release air bubbles.

Grout/Mortar with coarse aggregate; prepare specimens according to Test Method Nev. T428.

4. Striking off and covering. The surface of the grout/mortar shall be struck off, without undue manipulation, using a wood float or trowel. All completed specimens shall be covered immediately using the lid provided with the mold, to prevent loss of moisture, seal the lid with duct tape. On the mold lid write the contract number, cylinder set number, quantity of cylinders (Ex. 1 of 3), mix design number and date.

NUMBER OF SPECIMENS

A minimum of three specimens shall be made for each test. These will be used to determine the 28-day strength. Additional specimens may be made for informational purposes if desired.

CURING SPECIMENS

During the first 48 hours of initial curing and after molding, store all test specimens in the same location under the same conditions that maintain the temperature immediately adjacent to the specimens in the range of 16°C to 27°C (60°F to 80°F) and prevent loss of moisture from the specimens. Storage temperatures may be regulated by means of ventilation or by evaporation of water from sand or burlap (temperature within damp sand and under wet burlap or similar materials will always be lower than the temperature in the surrounding atmosphere if evaporation takes place), or by using heating devices such as stoves, electric light bulbs, or thermostatically controlled heating cables. A temperature record of the specimens shall be established by means of maximum-minimum thermometer, record the high and low temperature on NDOT form 020-017 under remarks. Store specimens in tightly constructed, insulated, firmly braced wooden boxes, damp sand pits, temporary buildings at construction sites, under wet burlap in favorable weather, or in heavyweight closed plastic bags, or use other suitable methods, provided the foregoing requirements limiting specimen temperature and moisture loss are met. Remove specimens from storage and ship directly to the concrete laboratory as soon as possible after the initial field storage of 48 hours.

State of Nevada
Department of Transportation
Materials Division

**METHOD OF TEST FOR MAKING AND CURING
CONCRETE COMPRESSION TEST SPECIMENS IN THE FIELD**

SCOPE

This test method covers the procedures for making and curing concrete compression test cylinders in the field.

APPARATUS

1. Cylindrical molds, with non-absorbent surfaces, substantial enough to hold their shape during the molding of test specimens. The approved standard mold is 100 mm x 200 mm (4 in. x 8 in.). When the nominal maximum size of the coarse aggregate exceeds 25 mm (1 in.), use 150 mm x 300 mm (6 in. x 12 in.) molds.

The nominal maximum size is the smallest sieve opening through which the entire amount of aggregate passes.

2. Tamping rods, round, straight steel rod with the dimensions listed below. Having the tamping end or both ends rounded to a hemispherical tip of the same diameter as the rod.

Tamping Rod Requirements:

<u>Diameter of cylinder</u>	<u>Rod Dimensions</u>	
	<u>Diameter: ± 2 mm $1/16$ in.</u>	<u>Length: ± 100 mm (4 in.)</u>
100 mm (4 in.)	10 mm (3/8 in.)	300 mm (12 in.)
150 mm (6 in.)	16 mm (5/8 in.)	600 mm (24 in.)

3. Internal vibrators, with rigid or flexible shafts. The vibrator frequency shall be at least 7000 vibrations per minute while the vibrator is operating in the concrete. The diameter of the vibrator shall be no more than one-third the diameter of the cylinder mold and the combined length of the vibrator shaft and vibrating element shall exceed the depth of the section being vibrated by at least 75 mm (3 in.).
4. Mallet, with a rubber or rawhide head weighing 0.60 ± 0.02 kg (1.25 ± 0.50 lb).
5. Shovel, pails, trowel, scoop, etc.
6. Suitable pan, wheelbarrow or nonabsorbent mixing board of sufficient capacity to allow mixing of the entire sample.

SAMPLING

Obtain a representative sample per Test Method Nev. T425. The item being constructed shall be noted on NDOT form 020-017.

PROCEDURE

1. Begin the concrete cylinders within 15 minutes of obtaining the representative sample.
2. Specimens shall be molded on a level, rigid surface, free of vibration or other disturbances at a place as close as practicable to the location where they are to be stored. If it is not practicable to mold the specimens where they will be stored, they may be moved to the place of storage immediately after being struck off. All jarring, striking, tilting, or scarring the surface of the completed specimens shall be avoided when moving them to the storage area.
2. In 150 mm (6 in.) diameter molds, the concrete shall be placed, using a scoop, in three layers of approximately equal volume. In 100 mm (4 in.) diameter molds, the concrete shall be placed, using a scoop, in two layers of approximately equal volume. In placing each portion of concrete, the scoop or trowel shall be moved around the top edge of the mold as the concrete slides from it, in order to ensure a symmetrical distribution of the concrete and to minimize segregation of the coarse aggregate within the mold.
3. Preparation of satisfactory specimens may require different methods of consolidation. The methods of consolidation are rodding and internal vibration. Base the selection of the method of consolidation on the slump, unless the method is stated in the specifications under which the work is being performed. Rod concrete with a slump greater than 75 mm (3 in.). Rod or vibrate concrete with slump of 25 to 75 mm (1 to 3 in.). Vibrate concrete with a slump of less than 25 mm (1 in.).

Rodding. Mold and rod in accordance with Table 1. Each layer shall be rodded 25 times. The strokes shall be distributed uniformly over the cross section of the mold. In rodding the first layer use sufficient force to penetrate the entire depth without denting or cracking the bottom of the mold. Each successive layer should be rodded enough to penetrate about 25 mm (1 in.) into the underlying layer. After each layer is rodded, tap the outside of the mold lightly 10 to 15 times with the mallet to close any holes left by rodding and to release any large air bubbles that may have been trapped. Avoid overfilling by more the 6 mm (0.25 in.) when adding the final layer.

Table 1
Molding Requirements by Rodding:

<u>Diameter of Cylinder</u>	<u>Number of Layers</u>	<u>Number of Rods per Layer</u>	<u>Approx. Depth of Layer</u>
100 mm (4 in.)	2	25	½ depth of specimen
150 mm (6 in.)	3	25	⅓ depth of specimen

Vibration. Mold and vibrate in accordance with Table 2. Place all the concrete, for each layer, in the mold before starting vibration of that layer. Allow the vibrator to penetrate through the layer being vibrated, and into the layer below, approximately 25 mm (1 in.). The vibrator shall not be allowed to rest on or touch the bottom or sides of the mold. Carefully withdraw the vibrator in such a manner as to avoid air pockets being left in the specimen. After vibration of each layer, tap the sides of the mold 10 to 15 times with a mallet to ensure removal of large entrapped air bubbles at the surface of the mold. When adding the final layer, avoid overfilling by more than 6 mm (0.25 in.). The duration of vibration required will depend upon the work ability of the concrete and the effectiveness of the vibrator. In most cases, sufficient vibration has been applied as soon as the surface of the concrete has become relatively smooth. Continue vibration only long enough to achieve proper consolidation of the concrete. Over vibration may cause segregation.

Table 2
Molding Requirements by Vibration:

<u>Diameter of Cylinder</u>	<u>Number of Layers</u>	<u>Number of Vibrator Insertions per Layer</u>	<u>Approx. Depth of Layer</u>
100 mm (4 in.)	2	1	½ depth of specimen
150 mm (6 in.)	3	2	⅓ depth of specimen

4. Striking off and covering. After consolidation, the surface of the concrete shall be struck off, without undue manipulation, using a wood float, trowel or the tamping rod where the consistency of the concrete permits. All completed specimens shall be covered immediately using the lid provided with the mold, to prevent loss of moisture, seal the lid with duct tape. On the mold lid write the contract number, cylinder set number, quantity of cylinders (Ex. 1 of 5), mix design number and date.

CURING SPECIMENS

Method A: Standard Curing (Specimens for determining compliance with ultimate strength specifications):

During the first 48 hours of initial curing and after molding, store all test specimens in the same location under the same conditions that maintain the temperature immediately adjacent to the specimens in the range of 16°C to 27°C (60°F to 80°F) and prevent loss of moisture from the specimens. Storage temperatures may be regulated by means of ventilation or by evaporation of water from sand or burlap (temperature within damp sand and under wet burlap or similar materials will always be lower than the temperature in the surrounding atmosphere if evaporation takes place), or by using heating devices such as stoves, electric light bulbs, or thermostatically controlled heating cables. A temperature record of

the specimens shall be established by means of maximum-minimum thermometer, record the high and low temperature on NDOT form 020-017 under remarks. Store specimens in tightly constructed, insulated, firmly braced wooden boxes, damp sand pits, temporary buildings at construction sites, under wet burlap in favorable weather, or in heavyweight closed plastic bags, or use other suitable methods, provided the foregoing requirements limiting specimen temperature and moisture loss are met. Remove specimens from storage and ship directly to the concrete laboratory as soon as possible after the initial field storage of 48 hours.

Method B : Field Curing (Specimens for determining the earliest date a structure may be put into service):

After the initial 24-hour storage period per Method A, the specimens shall be placed in or on the structure as near to the point of sampling as possible, and shall receive, insofar as practicable, the same protection from the elements as is given to the portion(s) of the structure which they represent for another 24 hours. In simulating these conditions, the test specimens are relatively small and therefore more quickly affected by freezing or drying conditions than the much larger volume of concrete in the structure. The specimens must also be protected from injury while on the worksite. A temperature record of the specimens shall be established by means of maximum-minimum thermometer, record the high and low temperature on NDOT form 020-017 under remarks. These specimens are presumed to show the compressive strength of the portion(s) of the structure they represent at a given time and under field curing conditions. Therefore, such specimens should be kept in the field as long as possible, preferable right up to a day or two before being tested. Remove specimens from the field and ship directly to the concrete laboratory after 48 hour storage period and in time for necessary testing as specified.

State of Nevada
Department of Transportation
Materials Division

**METHOD OF TEST FOR AIR CONTENT OF FRESHLY MIXED CONCRETE
BY THE VOLUMETRIC METHOD (ROLL-A-METER)**

SCOPE

This test method is for determining the air content of freshly mixed concrete. This method can be used for all classes of concrete.

APPARATUS

1. Air Meter, shall consist of a bowl for containing the fresh concrete, and a top section, both conforming to the requirements listed below: (See Fig. 1)
 - a. Bowl, shall be sufficiently rigid to withstand normal field use and of such construction as to resist attack from the cement paste. The diameter of the bowl shall be 1 to 1.25 times the height. The bowl shall have a capacity of not less than 0.002 m^3 (0.075 ft^3) and be constructed with a flange at or near the top surface.
 - b. Top Section, shall be sufficiently rigid to withstand normal field use and be resistant to chemical attack from the cement paste. The capacity of the top section should be approximately the same as the bowl. It shall be equipped with hooks or lugs and a flexible gasket that will form a watertight connection with the flanged end of the bowl. The top section shall be equipped with a glass or plastic lined neck, the neck must be graduated in increments not greater than 0.5 percent from 0 at the top to 9 percent or more of the volume of the bowl. The upper end shall be stoppered with a cap that forms a watertight seal.
2. Funnel, when inserted through the neck of the top section, will extend to a point just above the top of the bowl. The discharge end of the spout shall distribute the water added to the meter to cause a minimum disturbance to the concrete in the bowl.
3. Tamping Rod, a round straight steel rod, straight high density polyethylene or straight aluminum rod, with minimum dimensions of 16 mm (5/8 in.) in diameter and approximately 300 mm (12 in.) in length, having the tamping end rounded to a hemispherical tip of the diameter.
4. Strike-off Bar, a flat steel bar, flat high density polyethylene or flat aluminum rod, with minimum dimensions of 3 mm x 19 mm x 280 mm long (1/8 in. x 3/4 in. x 11 in. long),
5. Calibrated Measuring Cup, a metal or plastic cup having a capacity equal to 1.0 percent of the volume of the bowl of the air meter.

6. Syringe, small rubber bulb syringe having a capacity of at least that of the measuring cup.
7. Pouring Vessel, a metal, glass or plastic container of approximately 1 L (1 qt) capacity.
8. Mallet, with a rubber or rawhide head weighing 0.60 ± 0.02 kg (1.25 ± 0.50 lb).
9. Small Tools, trowel, small metal scoop.
10. 70% Isopropyl Alcohol.

CALIBRATION OF METER

1. The volume of the bowl of the air meter, in cubic meters or cubic feet, shall be determined by accurately weighing the amount of water at $25 \pm 3^{\circ}\text{C}$ ($77 \pm 5^{\circ}\text{F}$) required to fill it, and dividing this mass by 999.6 kg/m^3 (62.4 lb/ft^3). A cover plate (made of glass or acrylic) shall be used to cover the bowl to remove excess water and to insure that the container is full.
2. The accuracy of the graduations on the neck of the top section of the air meter shall be determined by filling the assembled measuring bowl and top section with water to the level of the mark for any air content. A quantity of water at $25 \pm 3^{\circ}\text{C}$ ($77 \pm 5^{\circ}\text{F}$) equal to 1.0 percent of the volume of the bowl, shall be added to the water already in the neck. The height of the water column shall increase by an amount equivalent to 1.0 percent of the air.
3. The volume of the measuring cup shall be checked by adding one cupful of water to the air meter in the manner described in paragraph 2, above. Such additions shall increase the height of the water column by an amount equivalent to 1.0 percent of air.
4. If the meter does not meet the calibration criteria, the meter needs to be repaired or replaced.

SAMPLING

1. Obtain a representative sample of fresh concrete per Test Method Nev. T425.
2. If the concrete contains coarse aggregate particles larger than 25 mm (1 in.), wet sieve a representative sample over a 25 mm (1 in.) sieve to obtain more than what is required to fill the bowl of the roll-a-meter. Place only enough concrete on the sieve at any one time so that after sieving, the thickness of the layer of retained aggregate is not more than one particle thick. Do not scrape mortar off of the coarse aggregate retained on the sieve, dispose of all aggregate retained on the sieve. Scrape mortar off of the sieve and add it to the material passing the 25 mm (1 in.) sieve. Once enough concrete has been obtained for the test, remix the concrete into a uniform sample and proceed with testing immediately.

PROCEDURE

1. This test shall be started within 5 minutes of obtaining the representative sample.

2. Dampen the inside of the bowl. Using the scoop, fill the measuring bowl with concrete in two equal lifts. Rod each lift 25 times with the tamping rod. Do not forcibly strike the bottom of the measuring bowl when rodding the first lift. When rodding the next lift, penetrate the previous lift approximately 25 mm (1 in.). After rodding each lift, tap the sides of the bowl 10 to 15 times with a mallet to close the voids left by the tamping rod.
3. After the top lift has been placed, tamped, and the voids rodded closed. Strike-off the excess concrete with the strike-off bar until a smooth surface is obtained. Clean the rim and flange of the measuring bowl with a damp sponge.
4. Clamp the top section tightly into position on the measuring bowl, insert the funnel into the neck and add 1 to 2 pints of Isopropyl Alcohol. Finish filling the top section with water until it appears in the neck. Remove the funnel and using the rubber syringe adjust the water level until the bottom of the meniscus is level with the zero mark. Attach and tighten the cap.
5. Invert and agitate the air meter until the concrete dislodges from the measuring bowl. Quickly invert the air meter, shake the base horizontally, and return the air meter to the upright position. To prevent the aggregate from lodging in the neck of the air meter, do not keep it inverted for more than 5 seconds at a time. Repeat the inversion and shaking process until the concrete has broken free and the aggregate can be heard moving in the air meter as it is inverted. Once, the concrete has been dislodged from the measuring bowl, place the air meter on the ground. Place one hand on the neck and the other hand on the flange and tip the air meter at a 45° angle while the base is still in contact with the ground. Vigorously roll the air meter a ¼ to ½ turn back and forth several times, while quickly starting and stopping the rolling process. Repeat this process until all the air appears to have been removed from the concrete. If at any time during this process, liquid leaks from the air meter, the test is invalid and a new test shall be started. Set the air meter upright, loosen the cap and tilt the air meter slightly at a 20° angle allowing the air to rise to the top and the liquid level to stabilize.
6. After all the air has been removed from the concrete allowing it to rise to the top of the neck, set the air meter flat on the surface and remove the cap.
7. Make a direct reading of the water level in the neck, reading to the bottom of the meniscus, and estimating to the nearest 0.25 percent. If a direct reading cannot be determined due to an unclear line of demarcation between the foam mass and the liquid, add in one calibrated measuring cup of Isopropyl Alcohol, add additional increments of Isopropyl Alcohol one at a time with the bulb syringe to dispel the foam mass on the surface of the water, once added stir the foam mass with a non-absorbent device, small enough to fit in the neck and until a line can be read. (One calibrated measuring cup of Isopropyl Alcohol is equivalent to 1.0 percent of air). When Isopropyl Alcohol is added, take the direct reading of the liquid and add the total cups of Isopropyl Alcohol to the direct reading to obtain the air content.

No Additional Alcohol added: 4.5% = 4.5% Air Content

Additional Alcohol added: Final reading with Isopropyl Alcohol 4.5% + 2 calibrated measuring cups of Isopropyl Alcohol added = 6.5% Air Content

8. Once the air content reading has been taken disassemble the meter. Dump the contents of the bowl out and verify that there are no undisturbed portions of tightly packed concrete in the bowl. If there are portions of undisturbed concrete in the bowl, the test is invalid and another test shall be ran.

REPORT

Report the air content to the nearest 0.25%. Results should be documented on NDOT form 020-017.



Brass Roll-A-Meter



Light Weight Roll-A-Meter

State of Nevada
Department of Transportation
Materials Division

**METHOD OF TEST FOR AIR CONTENT OF FRESHLY
MIXED CONCRETE BY THE PRESSURE METHOD**

SCOPE

This test method describes the equipment and procedures used for determining the air content of freshly mixed concrete. This method is to be used with dense aggregate and normal weight concrete. This test method shall not be used with lightweight aggregates, air cooled blast furnace slag, or aggregates with high porosity. Test Method Nev. T431 shall be used for Air Content of Freshly Mixed Concrete by Volumetric Method with lightweight aggregates.

APPARATUS

1. Air Meter - Type B (See Figure 1).
 - a. Measuring bowl, flanged or otherwise constructed cylindrical bowl made of hard metal resistant to corrosion by the cement paste. The diameter of the bowl shall be equal to 0.75 to 1.25 times the height and a capacity of at least 0.0057m^3 (0.20 ft³).
 - b. Cover assembly, shall be made of hard metal resistant to corrosion by the cement paste, smoothly machined interior surfaces contoured to provide an air space above the level of the top of the bowl and flanged or otherwise constructed such that the cover and the measuring bowl can be fitted together into a pressure-tight assembly. The cover shall be fitted with a gauge for obtaining a direct reading of air content. The graduations for a suitable range in air content shall be within 0.1%. The cover shall be fitted with an air bleeder valve for venting of the air chamber, a main air valve, and petcocks for bleeding off water as required. Suitable means of clamping the cover to the bowl shall be provided to make a pressure-tight seal without entrapping air at the joint between the flanges of the cover and bowl. A suitable hand pump shall be provided with the cover.
2. Scoop, large enough to obtain a representative sample of concrete.
3. Tamping rod, round, straight steel rod, 16 mm (5/8 in.) in diameter and not less than 400 mm (16 in.) in length, having the tamping end rounded to a hemispherical tip.
4. Internal vibrators, may have rigid or flexible shaft. The frequency of vibration shall be 7000 vibrations per minute or greater while in use. The outside diameter or the side dimensions of the vibrating element shall be at least 19 mm (3/4 in.) and not greater than 38 mm (1 1/2 in.). The length of the shaft shall be at least 600 mm (24 in.).

5. Rubber mallet, weighing approximately 0.60 ± 0.25 kg (1.25 ± 0.50 lb) for use with measuring bowl of 0.0142 m³ (0.5 ft³) or less, and a mallet weighing approximately 1.0 ± 0.25 kg (2.25 ± 0.50 lb) for use with measuring bowl larger than 0.0142 m³ (0.5 ft³).
6. Strike-off bar, flat, straight steel bar or other suitable material which is at least 300 mm (12 in.) in length.
7. Strike-off plate, flat, rectangular metal plate at least 6 mm (1/4 in.) thick glass or acrylic plate at least 13 mm (1/2 in.) thick with a length and width at least 50 mm (2 in.) greater than the diameter of the measure with which it is to be used. The edges of the plate shall be straight and smooth within a tolerance of 1.5 mm (1/16 in.)
8. Syringe, small rubber bulb type.
9. Sponge or towel.
10. Calibration vessel, which represents 5% air by volume.
11. Calibration tubes, one bent tube and one straight tube.

CALIBRATION OF AIR METER

1. Calibrate the Air Meter - Type B daily prior to use.
2. Fill the measuring bowl with water at $25 \pm 3^{\circ}\text{C}$ ($77 \pm 5^{\circ}\text{F}$).
3. Strike the sides of the measuring bowl with a rubber mallet to remove excessive air bubbles from the water.
4. Thread the short piece of straight tubing into the threaded petcock opening on the underside of the cover assembly. Clamp the cover assembly on the measuring bowl with the tube extending down into the water.
5. Using the syringe provided, add water at $25 \pm 3^{\circ}\text{C}$ ($77 \pm 5^{\circ}\text{F}$) to the measuring bowl through the petcock with the threaded tube until all air is expelled through the opposite petcock.
6. Pump up the air pressure to just beyond the predetermined initial pressure line (I/P). Wait a few seconds for the gauge hand to stabilize, then add or release air as necessary to stabilize the gauge hand at the initial pressure line (I/P).
7. Close both petcocks and immediately press the main air valve to release air into the base. Tap the gauge lightly with your fingers while holding down the main air valve lever. The gauge hand should read zero. If two or more tests show a variation greater than 0.1% from zero, follow specification protocol to reestablish initial pressure line (I/P).

8. Screw the curved tube provided into the threaded outside opening of the petcock. By pressing on the main air valve lever and controlling the flow with the petcock lever, carefully fill the plastic calibration vessel exactly full of water.
9. Release air pressure by opening the petcock without the tubing. Open the other petcock and allow water from the tube to run back into the measuring bowl. There is now 5% air in the measuring bowl.
10. With both petcocks open, follow the procedure in step six to pressurize the gauge to the initial pressure line (I/P). Close the petcocks and immediately press the main air valve lever. Stabilize the gauge hand as before. The gauge should read 5.0%.
11. If two or more tests indicate a variation of more than 0.1%, reset the gauge hand to 5.0%. Retest to ensure settings are correct by following steps two through nine.

SAMPLING

Sample fresh concrete in accordance with Test Method Nev. T425.

PROCEDURE

1. Referee or dispute testing shall be performed using Test Method Nev. T431.
2. Dampen all equipment and place the measuring bowl on a rigid surface that is level and stable. There shall be no excessive water left standing inside the measuring bowl before testing.
3. Filling the measure and consolidating.
 - a. Method of consolidation should be determined per the results of the slump test, unless the method is stated in the specifications under which the work is being performed. The methods of consolidation are rodding and internal vibration. Rod concrete with a slump greater than 75 mm (3 in.). Rod or vibrate concrete with a slump of 25 to 75 mm (1 to 3 in.). Vibrate concrete with a slump less than 25 mm (1 in.).
 - b. Rodding - Place the concrete in the measure in three layers of approximately equal volume. Rod each layer with 25 strokes of the tamping rod. Rod the bottom layer throughout its depth but the rod shall not forcibly strike the bottom of the measure. Distribute the strokes uniformly over the cross section of the measure and for the top two layers, penetrate about 25 mm (1 in.) into the underlying layer. After each layer is rodded, lightly tap the sides of the measure 10 to 15 times with the appropriate mallet to close any voids left by the tamping rod and to release any larger air bubbles that may have been trapped. Add the final layer so as to avoid overfilling.

- c. Internal Vibration - Fill and vibrate the measure in three layers of approximately equal volume. Place all of the concrete for each layer in the measure before starting vibration of that layer. Insert the vibrator at three different points for each layer. Throughout the consolidation process, do not allow the vibrator to rest on or touch the bottom or sides of the measure. The vibrator shall penetrate into the previous layer approximately 25 mm (1 in.). When withdrawing vibrator, take care to avoid any air pockets being left in the specimen. The duration of vibration required will depend upon the workability of the concrete and the effectiveness of the vibrator. Continue vibration just long enough to achieve proper consolidation of the concrete. Usually, sufficient vibration has been applied as soon as the surface of the concrete becomes relatively smooth. Over vibration may cause segregation and loss of appreciable quantities of entrained air.
4. After consolidating the concrete, strike off the excess concrete with the strike-off bar or the strike-off plate until the surface is flush with the top of the bowl. Clean the top flange of the measuring bowl to ensure a proper seal.
5. Clamp the top section onto the measuring bowl. Open both petcocks. Using the rubber bulb syringe, gently inject water through one petcock while jarring the air meter until water emerges from the opposite petcock and visible air bubbles have been expelled.
6. Close the air bleeder valve on the air chamber and pump air into the air chamber until the gauge hand is on the initial pressure line (I/P). Allow a few seconds for the compressed air to cool to normal temperature. Gently tap the gauge with one hand while slowly opening the air bleeder valve until the needle rests exactly on the initial starting point. If too much air is released, then add air again and repeat this step. Close both petcocks and open the main air valve while simultaneously hitting the measuring bowl with the mallet. Lightly tap the gauge to settle the needle. After the needle has stabilized, read the air content to the nearest 0.1 percent. After this reading has been obtained, release the main air valve.

Note: Failure to close the main air valve before releasing the pressure from either the container or the air chamber will result in water being drawn into the air chamber. Open both petcocks to release the pressure in the measuring bowl, remove the cover and thoroughly clean the bowl and the cover. Release the remaining air in the pressure chamber only after cleaning the cover.

7. Subtract the aggregate correction factor percentage obtained from the Mix Design from the gauge reading. This will give you the corrected air content percentage. Report this to the nearest 0.1 percent.

Example: Apparent Air Content - Aggregate Correction Factor = Air Content

$$5.2\% - 0.2\% = 5.0\%$$

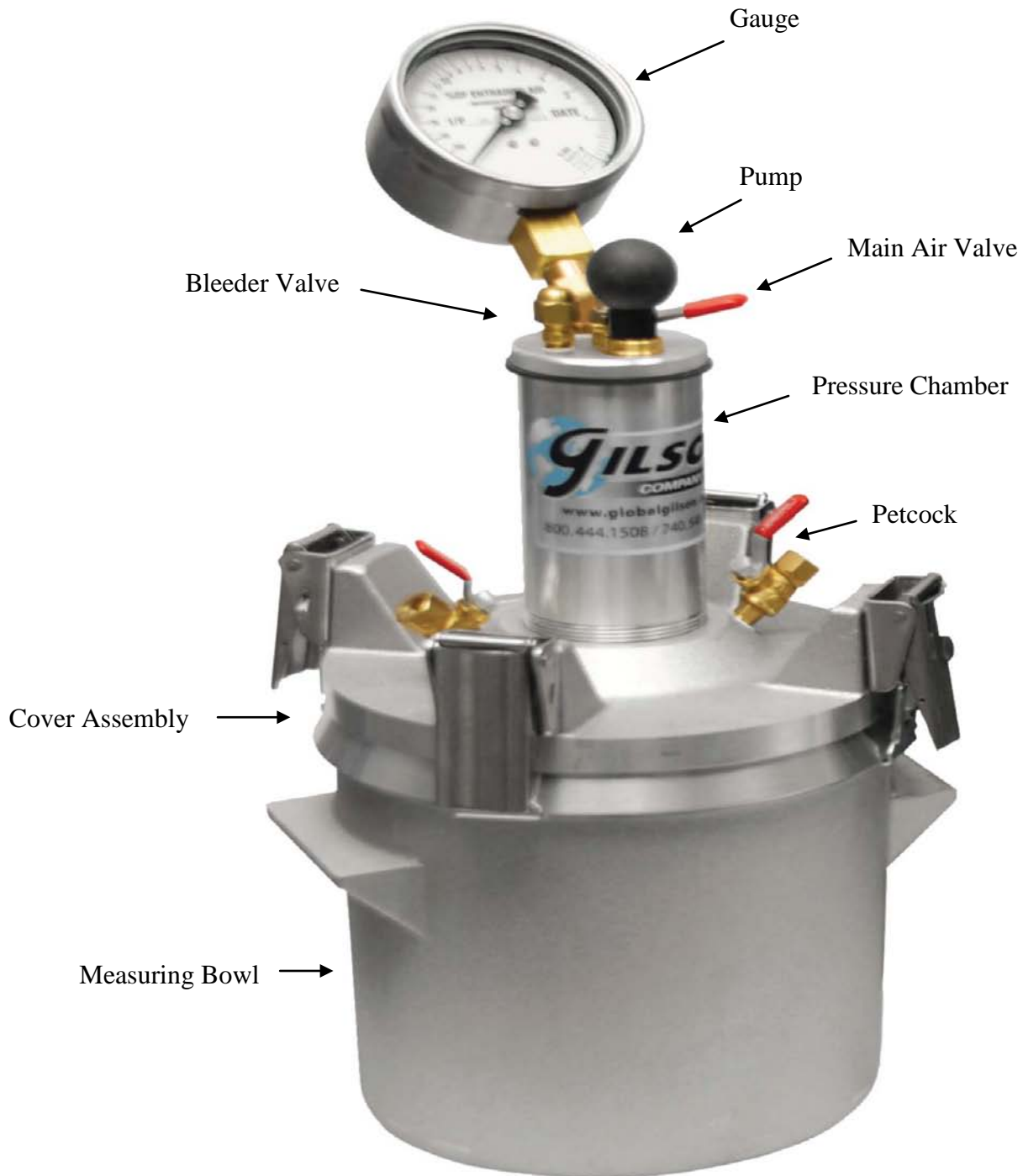

Figure 1

State of Nevada
Department of Transportation
Materials Division

METHOD OF TEST FOR DENSITY (UNIT WEIGHT) AND VOLUME OF CONCRETE

SCOPE

This test method describes the procedure for determining the density (unit weight) in kg/m^3 (lb/ft^3) of freshly mixed concrete and furnishes formulas for calculating the volume of concrete per batch (yield).

APPARATUS

1. Scale, minimum capacity of 45 kg (100 lb), sensitive to 0.1.
2. Measure, a cylindrical, watertight steel or aluminum measure having a nominal capacity of 14 L (0.5 ft^3) provided with handles, for maximum size aggregate up to 63 mm ($2 \frac{1}{2} \text{ in.}$). It shall have an inside diameter of 254 mm (10 in.) and an inside height of 279 mm (11 in.). The top rim shall be machined to a plane surface. The measuring bowl from the Type B – Air Meter may be used as the measure, for maximum size aggregate up to 25 mm (1 in.).
3. Tamping rod, a round, straight, steel rod, 16 mm ($\frac{5}{8} \text{ in.}$) in diameter approximately 600 mm (24 in.) long, having one end rounded to a hemispherical tip of the same diameter.
4. Internal vibrators, may have rigid or flexible shafts, preferably powered by electric motors. The frequency of vibration shall be 7000 vibrations per minute or greater while in use. The outside diameter or the side dimensions of the vibrating element shall be at least 19 mm ($\frac{3}{4} \text{ in.}$) and not greater than 38 mm ($1 \frac{1}{2} \text{ in.}$). The length of the shaft shall be at least 600 mm (24 in.).
5. Strike-Off plate, made of metal, reinforced glass or acrylic, approximately 300 mm (12 in.) square, 6 mm to 12 mm ($\frac{1}{4} \text{ in.}$ to $\frac{3}{4} \text{ in.}$) thick.
6. Mallet, with a rubber or rawhide head, weighing approximately $0.60 \pm 0.25 \text{ kg}$ ($1.25 \pm 0.50 \text{ lb}$) for use with measure of 0.0142 m^3 (0.5 ft^3) or less, or a mallet weighing approximately $1.0 \pm 0.25 \text{ kg}$ ($2.25 \pm 0.50 \text{ lb}$) for use with a measure larger than 0.0142 m^3 (0.5 ft^3).
7. Sponge or towel.
8. Large Scoop.

CALIBRATION OF MEASURE

The calibration factor (f), shall be verified at the start of each contract and any time there is reason to suspect a change. Weigh the empty, dry measure and strike-off plate to the nearest 0.1 kg (0.1 lb) to obtain the tare weight. Fill the measure up with water having a temperature of $25 \pm 3^{\circ}\text{C}$ ($77 \pm 5^{\circ}\text{F}$). Place the strike-off plate firmly in contact with the rim of the measure and add water if necessary to eliminate bubbles under the glass. Wipe surplus water from the outside of the measure and strike-off plate, weigh to the nearest 0.1 kg (0.1 lb). Take the total mass of the measure, water and strike-off plate and subtract the tare weight. Take 999.6 kg/m^3 (62.4 lb/ft^3) / [Total Mass (measure, strike-off plate, and water) – Tare Weight (empty measure and strike-off plate)] to determine the calibration factor to the nearest 0.1 kg (0.001 lb).

Example: 999.6 kg/m^3 (62.4 lb/ft^3) / [Total Mass (measure, strike-off plate, and water) – Tare Weight (empty measure and strike-off plate)] = f (calibration factor)

SAMPLING

Obtain a representative sample per Test Method Nev. T425.

TEST PROCEDURE

1. This test shall be started within 15 minutes of obtaining a representative sample.
2. Filling the measure and consolidating.
 - a. Dampen the measure and place on a flat level surface.
 - b. Method of consolidation should be determined per the results of the slump test, unless the method is stated in the specifications under which the work is being performed. The methods of consolidation are rodding and internal vibration. Rod concrete with a slump greater than 75 mm (3 in.). Rod or vibrate concrete with a slump of 25 to 75 mm (1 to 3 in.). Vibrate concrete with a slump less than 25 mm (1 in.).
 - c. Rodding - Place the concrete in the measure in three layers of approximately equal volume. Rod each layer with 25 strokes of the tamping rod. Rod the bottom layer throughout its depth but the rod shall not forcibly strike the bottom of the measure. Distribute the strokes uniformly over the cross section of the measure and for the top two layers, penetrate about 25 mm (1 in.) into the underlying layer. After each layer is rodded, lightly tap the sides of the measure 10 to 15 times with the appropriate mallet to close any voids left by the tamping rod and to release any larger air bubbles that may have been trapped. Add the final layer so as to avoid overfilling.

- d. Internal Vibration - Fill and vibrate the measure in three layers of approximately equal volume. Place all of the concrete for each layer in the measure before starting vibration of that layer. Insert the vibrator at three different points for each layer. Throughout the consolidation process, do not allow the vibrator to rest on or touch the bottom or sides of the measure. The vibrator shall penetrate into the previous layer approximately 25 mm (1 in.). When withdrawing the vibrator, take care to avoid any air pockets being left in the specimen. The duration of vibration required will depend upon the workability of the concrete and the effectiveness of the vibrator. Continue vibration just long enough to achieve proper consolidation of the concrete. Usually, sufficient vibration has been applied as soon as the surface of the concrete becomes relatively smooth. Over vibration may cause segregation and loss of appreciable quantities of entrained air.
3. Strike-off, cleaning and weighing
 - a. After the last layer has been properly consolidated, use the tamping rod held horizontally to strike off the top surface to its approximately correct elevation. Work the rod back and forth across the top with a sawing motion until a reasonably plane surface is obtained with all particles of coarse aggregate well buried. Clean the rim of the measure for a distance of about 150 mm (6 in.). Place one side of the strike-off plate firmly in position on the cleaned portion of the rim. Advance the strike-off plate with a sawing motion across the measure using sufficient pressure to maintain tight contact with the rim. There should always be a slight surplus of mortar ahead of the strike-off plate. If particles of coarse aggregate appear in front of the advancing edge of the strike-off plate, use your hand to shove them down into the concrete. Using a cloth or damp sponge, clean off all the extra concrete or other material adhering to the outside of the measure and strike-off plate. Weigh the filled measure with the strike-off plate to the nearest 0.1 kg (0.1 lb.) and record the weight.
 - b. Slide the strike-off plate off the measure using a sawing motion. Examine the surface for evidence of incomplete filling of the measure. A slight depression of the surface near one edge of the measure and shallow voids up to 19 mm (3/4 in.) in diameter with a depth no greater than 1.5 mm (1/16 in.) may be disregarded. Deeper voids are indications that the measure was incompletely filled. In case of uncertainty, add a small amount of concrete and repeat the operations of screeding with the rod and working the strike-off plate into position. Weigh again. If the new mass agrees within 0.1 kg (0.1 lb) of the first mass, the original mass may be taken as correct.

CALCULATIONS

1. Density (unit weight), W , in kg/m^3 (lb/ft^3). Calculate the density (unit weight) of the concrete in kg/m^3 (lb/ft^3) by multiplying the net weight of the concrete in the container by the calibration factor (f), determined for the measure used.

Gross Weight (concrete, measure and strike-off plate) – Tare Weight (dry measure and strike-off plate) =
Net Weight (concrete) x f (calibration factor) = W (Density (Unit Weight)) to the nearest 0.001 kg/m^3
(0.1 lb/ft^3).

2. The volume of concrete, S, per batch is calculated as follows:

$$S = \frac{W_a + W_1 + W_c + W_w}{W}$$

Where:

S = volume of concrete per batch in cubic feet (cubic meter).

W_a = total cement in the batch in pounds (kilograms).

W₁ = total fine aggregate, including moisture as batched, in pounds (kilograms).

W_c = total coarse aggregate, including moisture as batched, in pounds (kilograms).

W_w = total mixing water added during mixing per batch, in pounds (kilograms).

W = density (unit weight) of the fresh concrete as determined under (1) above, in pounds per cubic foot (kilograms per cubic meter).

NOTES

This Test Method Nev. T435, the 14 L (0.5 ft³) measure shall be used for concrete containing up to 63 mm (2 1/2 in.) maximum size of aggregate. When testing for unit weight with concrete aggregate of 50 mm (2 in.) or larger, two tests shall be made from the same batch. The average of the two tests shall be reported as a single determination. The measuring bowl from the Type B – Air Meter may be used as the measure, for maximum size aggregate up to 25 mm (1 in.).

REPORT

Report W, Density (Unit Weight) to the nearest 0.001 kg/m³ (0.1 lb/ft³). Results should be recorded on NDOT form 020-017, 040-025 and/or 040-078. If not filling out NDOT form 040-025 then 040-078 should be utilized.

State of Nevada
Department of Transportation
Materials Division

**METHOD OF TEST FOR SLUMP OF PORTLAND CEMENT CONCRETE
(CONE METHOD)**

SCOPE

This test method covers the procedure to be used for determining slump of concrete, both in the laboratory and in the field. This test is not considered applicable to nonplastic and noncohesive concrete, nor when there is coarse aggregate 50 mm (2 in.) in size or larger in the concrete.

APPARATUS

1. Mold, the test specimen shall be formed in a mold made of metal not readily attacked by the cement paste. The metal shall not be thinner than 1.5 mm (0.060 in.), and if formed by the spinning process, there shall be no point on the mold at which the thickness is less than 1.14 mm (0.045 in.). The mold shall be in the form of the lateral surface of a cone with the base 200 ± 3 mm (8 in. $\pm 1/8$ in.) in diameter, the top 100 ± 3 mm (4 in. $\pm 1/8$ in.) in diameter, and the height 300 ± 3 mm (12 in. $\pm 1/8$ in.). The base and the top shall be open and parallel to each other and at right angles to the axis of the cone. The mold shall be provided with foot pieces and handles. The mold may be constructed either with or without a seam. The interior of the mold shall be relatively smooth and free from projections such as protruding rivets. The mold shall be free from dents. A mold that clamps to a nonabsorbent base plate is acceptable provided the clamping arrangement is such that it can be fully released without movement of the mold.
2. Tamping Rod, a round, straight steel rod 16 mm (5/8 in.) in diameter and approximately 600 mm (24 in.) in length, having the tamping end rounded to a hemispherical tip of the same diameter.

SAMPLING

Obtain a representative sample per Test Method Nev. T425.

PROCEDURE

1. This test shall be started within 5 minutes of obtaining the representative sample. The entire operation from the start of the filling with fresh concrete through the removal of the mold shall be carried out without interruption and shall be completed within an elapsed time of 2 ½ minutes.

2. Dampen the mold and place it on a flat, moist, non-absorbent (rigid) surface. The operator standing on the foot pieces shall hold it firmly in place during filling. Immediately fill the mold in three layers, each approximately one-third the volume of the mold. One-third of the volume of the mold fills it to a depth of 68 mm (2 5/8 in.); two-thirds of the volume fills it to a depth of 156 mm (6 1/8 in.).
3. Rod each layer with 25 strokes of the tamping rod. Uniformly distribute the strokes over the cross section of each layer. For the bottom layer, this will necessitate inclining the rod slightly and making approximately half of the strokes near the perimeter, and then progressing with vertical strokes spirally toward the center. Rod the bottom layer throughout its depth. Rod the second layer and the top layer each throughout its depth, so that the strokes penetrate into the previous layer by approximately 25 mm (1 in.).

When filling and rodding the top layer, heap the concrete above the mold before rodding is started. If the rodding operation results in the concrete receding below the top edge of the mold, add additional concrete to keep an excess of concrete above the top of the mold at all times, continue the rod counts. After the top layer has been rodded, strike off the surface of the concrete by screeding and rolling motion of the tamping rod. Clean away all concrete spilled in the process of filling and rodding from around the base of the cone. Remove the mold immediately from the concrete by raising it carefully in a vertical direction. The operation of raising the mold shall be performed in 5 to 10 seconds by a steady upward lift with no lateral or torsional motion being imparted to the concrete.

4. Immediately measure the slump by determining the vertical difference between the top of the mold and the height of the displaced center of the top surface of the specimen. If a decided falling away or shearing off of concrete from one side or portion of the mass occurs, disregard the test and make a new test on another portion of the sample. If two consecutive tests on a sample of concrete show a falling away or shearing off of a portion of the concrete from the mass of the specimen, the concrete probably lacks necessary plasticity and cohesiveness for the slump test to be applicable.

REPORT

Record the slump to the nearest 6 mm (1/4 in.). Results should be documented on NDOT form 020-017.

State of Nevada
Department of Transportation
Materials Division

METHOD OF TEST FOR BALL PENETRATION IN FRESH PORTLAND CEMENT CONCRETE

SCOPE

This test method describes the procedure for determining the consistency of fresh concrete by measuring the depth of penetration of a metal weight.

APPARATUS

Ball penetration apparatus, consists of a 150 mm (6 in.) diameter steel cylinder with a height of 118 mm (4 5/8 in.) with a hemispherically shaped bottom that is machined to a smooth finish. The penetrator is attached to a shaft graduated to measure penetration to the nearest 6 mm (1/4 in.). The weight of the apparatus (ball, shaft, and handle), exclusive of the yoke, is 13.61 ± 0.05 kg (30 ± 0.1 lb). The handle shall be a metal rod, 13 mm (1/2 in.) in diameter and graduated in increments of 6 mm (1/4 in.), with each inch numbered from the zero point at the top of the yoke or sleeve. The handle may be T-shaped or a closed rectangle at the top to permit grasping by the hand.

For lightweight concrete, a modified ball is used for determining the consistency of fresh lightweight concrete. The modified ball is identical in shape and size to the 13.61 kg (30 lb) ball, but the weight of the lightweight apparatus (ball, shaft, and handle), exclusive of the yoke, is 9.1 ± 0.05 kg (20 ± 0.1 lb).

CALIBRATION

To calibrate, a zero reading is established by placing the ball and the feet of the yoke on a flat surface. The shaft is then adjusted by turning the threaded shaft in the ball penetrator to obtain a zero reading at the top of the yoke or sleeve. The lock nut at the top of the penetrator is then re-tightened.

PROCEDURE

1. The test may be performed on concrete in a wheelbarrow, buggy, other container, after it has been deposited in the forms or on the subgrade. The depth of the concrete above the bottom of the container or reinforcement shall be at least 150 mm (6 in.) for 25 mm (1 in.) maximum size aggregate or smaller, and 200 mm (8 in.) for larger maximum size aggregate.
2. The surface of the concrete to be tested is struck off level over an area of about three square feet. Do not tamp, vibrate or consolidate the concrete. Screed the minimum amount required to obtain a reasonably level surface. Overworking may flush excess mortar to the surface and cause erroneously high penetration readings.

3. Holding the device by the handle, lower it slowly over the prepared area until the feet of the yoke touch the surface of the concrete. Make certain the shaft is in a vertical position and free to slide through the yoke. Gradually lower the ball penetrator into the concrete, maintaining enough restraint on the handle so that penetration is due to the dead weight of the ball only and not to any force generated by dropping the ball. When the ball comes to rest, release the handle and read the penetration to the nearest 6 mm (1/4 in.). Penetration of the feet of more than 3 mm (1/8 in.) may indicate that the concrete has been overworked in screeding the surface, or that the yoke is binding on the shaft. Do not overwork the surface and re-test in another location.
4. For one penetration determination take three individual readings. Individual readings shall be at least 230 mm (9 in.) apart and at least 150 mm (6 in.) from a vertical edge. The reported penetration determination shall be the average of the first three individual readings.

Ex. $25 \text{ mm (1 in.)} + 30 \text{ mm (1 1/4 in.)} + 25 \text{ mm (1 in.)} = 80 \text{ mm (3.25 in.)} / 3 = 25 \text{ mm (1 in.)}$

REPORT

Report the average of the three readings to the nearest 6 mm (1/4 in.) of penetration determination. Results should be recorded on NDOT form 020-017.

State of Nevada
Department of Transportation
Materials Division

**METHOD OF TEST FOR MEASURING SURFACE TEMPERATURE OF
IN-PLACE PORTLAND CEMENT CONCRETE**

SCOPE

This test method describes the procedure for measuring the temperature of in-place portland cement concrete.

APPARATUS

Use a recording device approved by the Construction Division. The recorder must be capable of measuring and recording temperatures as specified in Subsection 501.03.10 of the Nevada Department of Transportation Standard Specifications for Road and Bridge Construction.

TEMPERATURE MEASUREMENT

Temperature shall be measured continuously, in increments of 1.1°C (2°F), immediately after placement and vibration. Surface temperature of the in place concrete shall be measured by placing the probe on the concrete surface at a point representing the mass of concrete placed, as approved by the Engineer. The unit shall be insulated from the influence of external temperature sources. The chart recorder shall be set to the correct time and actuated after installation. The Engineer will be responsible for maintenance and changing of charts.

REPORT

Record the contract number, date, time, stationing and type of placement on the back of the chart or the computer print out.

State of Nevada
Department of Transportation
Materials Division

**METHOD OF TEST FOR MEASURING TEMPERATURE OF
FRESH CONCRETE**

SCOPE

This test method describes the procedure for measuring the temperature of fresh concrete.

EQUIPMENT

1. Thermometer, glass or metal, liquid or digital, capable of accurately measuring from 0°C to 50°C (30°F to 120° F) and allows for 75 mm (3 in.) or more of immersion into the fresh concrete.
2. Container, shall be large enough to provide 75 mm (3 in.) of concrete coverage in all directions around the sensor of the thermometer and be at least three times the nominal maximum size of the coarse aggregate.

CALIBRATION

The thermometer shall be calibrated annually or whenever there is a question of accuracy.

SAMPLING

Obtain a representative sample of fresh concrete per Test Method Nev. T425.

PROCEDURE

1. This test shall be started within 5 minutes of obtaining a representative sample.
2. Submerge the temperature sensing portion of the thermometer into the fresh concrete a minimum of 75mm (3 in.). Gently press the surface of the fresh concrete around the thermometer to close any voids created during the insertion of the thermometer and to prevent the ambient air temperature from affecting the reading.
3. Leave the thermometer in the fresh concrete for a minimum of 2 minutes but no more than 5 minutes, read and record the temperature of the fresh concrete to the nearest 0.5° C (1° F). Do not remove the thermometer from the fresh concrete while reading the temperature.

REPORT

Report the temperature to the nearest 0.5° C (1° F). Results should be documented on NDOT form 020-017.

State of Nevada
Department of Transportation
Materials Division

**METHOD OF TEST FOR MAKING AND CURING CONCRETE BEAM SPECIMENS IN THE
FIELD AND FOR DETERMINING FLEXURAL STRENGTH OF CONCRETE
USING SIMPLE BEAM WITH THIRD-POINT LOADING**

SCOPE

This test method describes the procedure for making and curing beam specimens from representative samples of fresh concrete and the procedure used for determining the flexural strength of concrete by the use of a simple beam with third-point loading.

APPARATUS

1. Beam breaking machine, machines having the capacity, in one continuous stroke, to complete a test without requiring replenishment are permitted and shall be capable of applying loads at a uniform rate without shock or interruption. The testing machine shall conform to the requirement of the section on Basis of Verification, Corrections, and Time Interval between Verifications of Practices, ASTM E4.
2. Beam molds, molds shall be made of steel, cast iron, or other nonabsorbent material that is not reactive with concrete containing Portland or other hydraulic cements. Molds shall hold their dimensions and shape under all conditions of use and shall be watertight. Molds shall produce specimens that are 150 mm (6 in.) x 150 mm (6 in.) in cross section and at least 500 mm (20 in.) in length. Maximum variation from the nominal cross section shall not exceed 3 mm (1/8 in.). The inside surface shall be smooth. The sides, bottom, and ends shall be at right angles to each other and shall be straight and true and free of warpage.
3. Tamping rod, rod shall be made of steel and be round and straight. The rod shall be approximately 16 mm (5/8 in.) in diameter and 600 mm \pm 100 mm (24 \pm 4 in.) in length, with both ends rounded to a hemispherical tip of the same diameter.
4. Internal vibrators, vibrators may have rigid or flexible shafts. The frequency of vibration shall be 7000 vibrations per minute or greater while in use. The outside diameter or the side dimensions of the vibrating element shall be at least 19 mm (3/4 in.) and not greater than 38 mm (1 1/2 in.). The length of the shaft shall be at least 600 mm (24 in.).
5. Small hand tools, such as wood floats, 150 mm (6 in.) blunt end stainless steel trowel, rubber head mallet with a mass of 567 \pm 227 g (1.25 \pm 0.50 lb) and measuring tape or ruler with at least 1 mm (1/16 in.) graduations.

SAMPLING

1. Obtain a representative sample per Test Method Nev. T425. In the case of concrete deposited in front of a “slip-form paver,” the sample shall be taken from random points throughout the dumped loads in front of the paving machine.
2. Transport samples obtained as described above in watertight containers to the place where the test specimens are to be molded. A minimum of three samples shall be molded. Samples must be remixed with a shovel on a non-absorbent surface to assure that there is no segregation of the coarse aggregate or mortar.

MOLDING TEST SPECIMENS

1. Place the concrete in lightly oiled molds using a scoop. The oil used shall be mineral oil. If using a vibrator for consolidation, place concrete in one lift. Place enough concrete such that the mold will be slightly overfilled after consolidation. If a vibrator is not used for consolidation, place concrete in two layers of approximately equal volume and rod each layer. Place enough concrete in the second layer such that the mold will be slightly overfilled after consolidation. In placing each portion of concrete, the scoop or trowel shall be moved around the top edge of the mold as the concrete slides from it in order to ensure a symmetrical distribution of the concrete and minimize segregation of the coarse aggregate within the mold. The concrete may be further distributed by use of a tamping rod prior to the start of consolidation.
2. Preparation of satisfactory specimens requires different methods of consolidation. Concrete with a slump equal to or greater than 25 mm (1 in.) can be rodded or vibrated. Concrete with a slump of less than 25 mm (1 in.) shall be vibrated.
3. The number of roddings per layer shall be based upon the top surface area of the beam. Provide one rodding for each 1400 mm² (2 in.²) of surface area. Rod each layer throughout the depth without forcefully striking the bottom of the mold. After each layer is rodded, tap the outsides of the mold 10 to 15 times with a mallet to close any holes and to release any large air bubbles that may have been trapped.
4. Vibrate by inserting the vibrator at intervals not exceeding 150 mm (6 in.) along the centerline of the long dimension of the specimen. Place all concrete in the mold before starting vibration. Insert the vibrator slowly and do not allow the vibrator to touch the bottom or sides of the mold. Withdraw the vibrator slowly so no large air pockets are left in the specimen. Generally, no more than 5 seconds of vibration should be required for each insertion. Usually, sufficient vibration has been applied as soon as the surface of the concrete has become relatively smooth. Longer times may be needed for lower slump concrete. Once vibration is complete, tap the outsides of the mold 10 to 15 times with a mallet to close any holes and to release any large air bubbles that may have been trapped. After tapping, spade along the sides and ends of the beam molds with a trowel.
5. After consolidation, strike off excess concrete from the surface and float with a hand trowel. Finish with the minimum manipulation necessary to produce a flat even surface that is level with the rim of the mold and that has no depressions or projections larger than 3 mm (1/8 in.).

CURING TEST SPECIMENS

1. Place earth around the sides and ends of the molds to prevent excessive loss of heat generated by the chemical reaction in the concrete.
2. During the initial 24 hours, apply the same curing compound to the top surface of the test beam as is applied to the pavement. Apply the curing compound promptly to the surface of the beam or cover the beam immediately with a double thickness of burlap or other fabric that shall be kept thoroughly damp until the curing medium is applied. The objective sought in curing the beam is to provide the same temperature environment as that of the pavement.
3. At the end of the initial 24 hour cure time, remove from test site and transport the beam to the curing location. Then, carefully remove the beam from the mold and bury the beam in damp earth with at least 100 mm (4 in.) of cover over the top of the beam. Keep the earth surrounding the test beams damp at all times. Cover with a tarp or plastic sheeting to prevent excessive evaporation.

BEAM BREAKING PROCEDURE

1. Testing schedule
 - a. Break one beam at 10 days of age and one at 28 days of age. Thus, there will be one spare beam to test in case of a faulty break or if it is desired to vary the breaking schedule. The breaking schedule may be varied, if necessary, to determine the strength of the concrete before opening the pavement to traffic.
 - b. Keep beams thoroughly damp throughout the curing process until immediately prior to testing time. If beams are allowed to dry prior to testing, test results may be inaccurate.
 - c. Test beams promptly upon removal from the curing bed.
2. Testing procedure
 - a. Locate the testing machine on a firm foundation, away from the influence of vibrations. Break strength may be decreased if this step is disregarded.
 - b. Follow the operation manual to prepare the beam breaking machine for testing.
 - c. Brush the beam clean, place in the testing machine on its side with respect to its position as molded, and center it on the support blocks. Center the loading system in relation to the applied force. Bring the load-applying block in contact with the surface of the specimen at the third points and apply a load of between 3 and 6 percent of the estimated ultimate load. Use leather shims on the specimen contact surface to eliminate any gaps. Leather shims shall be of uniform 6 mm (1/4 in.) thickness, 25 to 50 mm (1 to 2 in.) in width, and shall extend across the full width of the specimen.

- d. Apply the load to the specimen continuously and without shock. The load shall be applied at a constant rate to the breaking point. Apply the load at a constant rate between 0.86 and 1.21 MPa/min (125 and 175 psi/min) until rupture occurs. When the loading rate needs to be calculated use the following equation:

$$r = Sbd^2/L$$

where:

r = loading rate, MN/min (lb/min),

S = rate of increase in extreme fiber stress, MPa/min (psi/min),

b = average width of the specimen, mm (in.),

d = average depth of the specimen, mm (in.),

L = span length, mm (in.).

3. Measurement of Specimens after Test

- a. To determine the dimensions of the specimen cross section for use in calculating modulus of rupture, take measurements across one of the fractured faces after testing. For each dimension, take one measurement at each edge and one at the center of the cross section. Use the three measurements for each direction to determine the average width and the average depth. When necessary, calculate the average distance between the line of fracture and the nearest support measured on the tension surface of the beam by measuring from the nearest support to the fracture along both edges of the beam and along the centerline of the tension surface, and average the three measurements. Take all measurements to the nearest 1 mm (1/16 in.).

CALCULATIONS

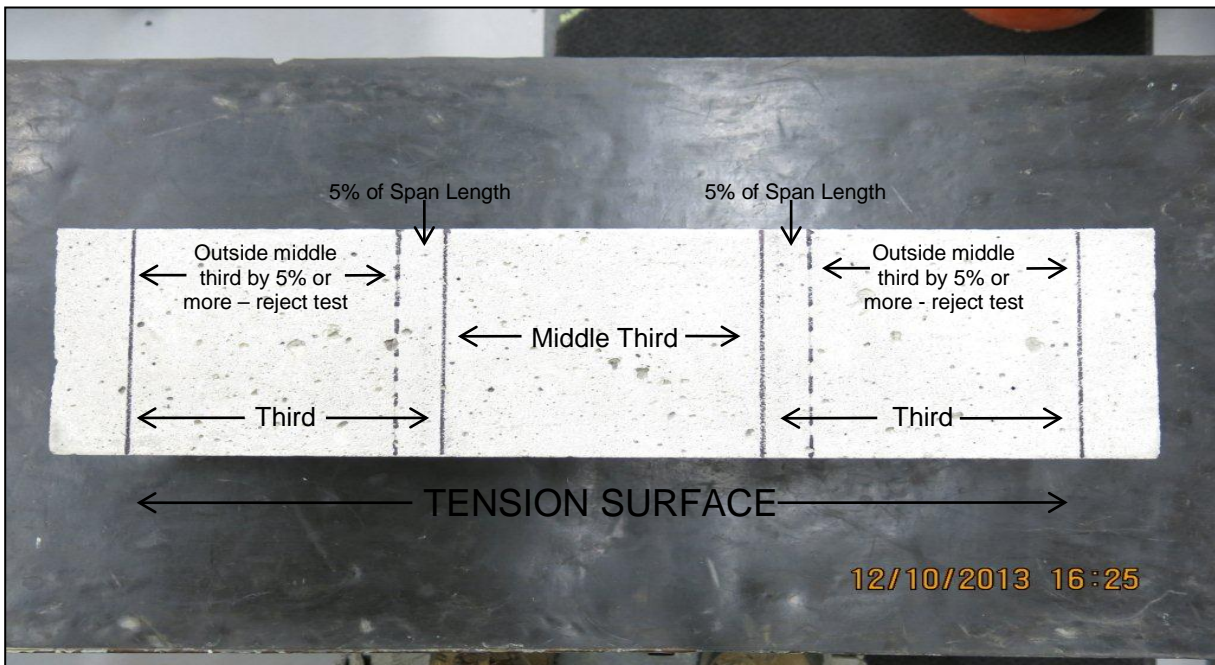

1. If the fracture initiates in the tension surface within the middle third of the span length and the testing machine supplies modulus of rupture (R), record results per the REPORT section.

If the fracture initiates in the tension surface within the middle third of the span length and the testing machine supplies maximum applied load (P), calculate the modulus of rupture (R) as follows:

$$R = PL/bd^2$$

where:

R = modulus of rupture, MPA (psi),

P = maximum applied load indicated by the testing machine, N (lbf),

L = span length, mm (in.),

b = average width of specimen, mm (in.) at the fracture,

d = average depth of specimen, mm (in.) at the fracture.

2. If the fracture occurs in the tension surface outside of the middle third of the span length by not more than 5% of the span length, and the testing machine supplies modulus of rupture (R), calculate maximum applied load (P) as follows:

$$P=Rbd^2/L$$

where:

P = maximum applied load, calculated, N (lbf),

R = modulus of rupture supplied by testing machine, MPA (psi),

L = span length, mm (in.),

b = average width of specimen, mm (in.) at the fracture,

d = average depth of specimen, mm (in.) at the fracture.

Then calculate an adjusted modulus of Rupture, (R) as follows:

$$R= 3Pa/bd^2$$

where:

R = adjusted modulus of rupture, MPA (psi),

P = maximum applied load calculated above, N (lbf),

a = average distance between the line of fracture and the nearest support measured on the tension surface of the beam, mm (in.),

b = average width of specimen, mm (in.) at the fracture,

d = average depth of specimen, mm (in.) at the fracture.

If the fracture occurs in the tension surface outside of the middle third of the span length by not more than 5% of the span length and the testing machine supplies maximum applied load (P), calculate the modulus of rupture, (R) as follows:

$$R = 3Pa/bd^2$$

where:

R = modulus of rupture, MPA (psi),

P = maximum applied load indicated by the testing machine, N (lbf),

a = average distance between the line of fracture and the nearest support measured on the tension surface of the beam, mm (in.),

b = average width of specimen, mm (in.) at the fracture,

d = average depth of specimen, mm (in.) at the fracture.

3. If the fracture occurs in the tension surface outside of the middle third of the span length by more than 5% of the span length, discard the results of the test.

REPORT

Report the modulus of rupture to the nearest whole number. Record the results on NDOT form 040-016.

State of Nevada
Department of Transportation
Materials Division

METHOD OF TEST FOR EVALUATION OF PAVEMENT PROFILES - ENGLISH

SCOPE

This test method describes the procedure used for determination and verification of the Profile Index from a pavement profile made with the California type profilograph (See Figure 8). This method also describes the procedure used to locate individual high points (must grinds).

The profile trace is recorded on a scale of 1 in. is equal to 25 ft longitudinally and 1 in. is equal to 1 in. (full scale) vertically. Determination of the Profile Index involves measuring scallops that appear outside a 0.2 in. wide shaded area of a blanking band. Determination of individual high points involves the use of a bump template as described in Section II of this test method.

EQUIPMENT

Profilograph, California type 25 ft wheel base. (Refer to Subsection 402.03.03 of the specifications for equipment requirements). Alternative equipment may be allowed if approved by the Engineer.

EQUIPMENT CALIBRATION

The profilograph should be checked for calibration of longitudinal distance and vertical height each time the profilograph is assembled, or at any time the Engineer deems necessary. The longitudinal distance calibration is to be performed by operating the profilograph at walking speed (approximately 3 mph) over a measured distance of 528 ft. The actual distance shown by the computer display must be within 0.5 ft. The vertical height calibration is to be performed by placing the center recording wheel of the profilograph on a flat surface. Two plates, each measuring 0.5 in. thick, are then placed under the center recording wheel, one at a time and the change in height noted. The two plates are then removed, one at a time and the change in height noted. Each step in this process shall show a change in height of 0.5 in. +/- 0.01 in. If the longitudinal distance or vertical height calibration is out of specification tolerance, follow the manufacturer's instructions to adjust the profilograph settings and recalibrate until the profilograph meets the specified tolerances. Provide the Engineer with a computerized printout to verify the profilograph calibration and parameter settings before testing pavement smoothness (See Figure 7). The tire pressure of the center recording wheel must be set and maintained at 25 psi unless the manufacturer specifies a different tire pressure setting. The tire pressure must be checked prior to the start of calibration.

SECTION 1 - VERIFICATION OF THE PROFILE INDEX

PROCEDURE

The pavement profile trace is produced and calculated by a computerized profilograph. The pavement profile trace shall be checked for accuracy using a plastic blanking band, 1.70 in. wide and 21.12 in. long (See Figure 1). The blanking band represents a pavement length of 528 ft or 0.1 mi at a scale of 1 in. = 25 ft.

At the center of the blanking band is a 0.2 in. wide shaded area that extends the entire length of the blanking band. Each side of the 0.2 in. shaded area has scribed lines 0.1 in. apart and parallel to the 0.2 in. shaded area. These lines serve as a convenient scale to measure deviations of the graph above or below the 0.2 in. shaded area. These are called scallops (See Figure 4). A blanking band may be obtained from the Construction Division, Quality Assurance Section.

Place the blanking band over the profile in such a way as to “blank out” as much of the profile as possible. Usually when this is done, scallops above and below the 0.2 in. shaded area are equally balanced (See Figure 2). Starting at the left end of the blanking band, measure and total the height of all the scallops appearing both above and below the 0.2 in. shaded area. Measure each scallop to the nearest 0.01 in. Write this total on the profile sheet near the left end of the blanking band. Mark the right end of the blanking band in the center of the 0.2 in. shaded area. This will align the scale when moving onto the next 0.1 mi, or fraction thereof.

When scallops occurring in the first 0.1 mi are totaled, slide the blanking band to the right, aligning the left side of the blanking band with the small mark previously made and proceed with counting in the same manner. The last section counted may or may not be an even 0.1 mi. If not, its length in miles needs to be calculated. The readings should be rounded to the nearest 0.001 mi. Each 0.1 mi section, or portion thereof, must be recorded on Form No. 040-073 and checked for conformance with the specifications. The specifications indicate which pavement smoothness type to use when computing the Profile Index.

The computerized profile trace may move from a generally horizontal appearance when going around super elevated curves and through rapid changes in elevation such as dips or humps. These changes will make it nearly impossible to blank out the middle portion of the trace without shifting the scale. When these changing conditions occur, the computerized profile trace should break into short sections to balance the scallops (See Figure 3).

LIMITATION OF MEASUREMENT

When counting profiles, a day’s production of pavement surface is considered to include the last portion of the previous work, which includes the take off joint. The last 30 ft of pavement surface cannot usually be obtained until the following day. If a line break, station equation, or exception (bridge deck, cattleguard, etc.) is encountered, the profilograph should be stopped at the point of the line break, station equation, or exception so that the ending station can be recorded. The profilograph should resume the run using the new station as the beginning point of the next section.

Example for in./0.1 mi Index:

	Section length, miles	in./0.1 mi
	0.100-----0.21 + 0.03 + 0.01 + 0.26 + 0.13 =	0.64
	0.100-----0.11 + 0.02 + 0.01 + 0.12 =	0.26
	* 0.071-----0.03 + 0.41 + 0.21 + 0.37 + 0.08 =	<u>1.10</u>
Totals	<u>0.271</u>	<u>2.00</u>

* A calculation will need to be made to determine a corrected measurement for short sections less than a 0.1 mi. This amount of roughness in each “one-tenth mile section” is converted to a relative profile. This calculation should be recorded in the remarks area on Form No. 040-073 “Report of Profilograph Test”, but should not be used for the overall Profile Index.

Using the example above:

$$\begin{aligned} \text{Short Section: Station } 111+08 - 107+32 &= 376 \text{ ft} \div 5280 \text{ ft} = 0.071 \text{ mi} \\ \text{Total count must be based on 0.1 mile section: } &0.1/.071 \times 1.10 = 1.55 \text{ in./0.1 mi} \end{aligned}$$

Each section must be “weighted” according to its length. This is most easily done by totaling the tenths of an inch for each 0.1 mi section of a given line or lines and using the total length of the line (up to 1 mi) in the computation for determining the Profile Index for a mile.

Example for in./mi Index:

Using the 0.271 and 2.00 totals from the above example:

$$\text{Inch Per Mile Index} = (1 \div 0.271) \times 2.00 = 7.380$$

REPORT

Report each in./0.1 mi to the nearest 0.01 in. and each 0.1 mi section to the nearest 0.001.

SECTION II - VERIFICATION OF HIGH POINTS (MUST GRINDS)

EQUIPMENT

Special equipment needed includes a plastic bump template, having a line 1 in. long scribed on one face with a small hole at either end, and a slot 0.3 in. (PCCP), 0.25 in. (Bridge Decks), 0.3 in. (Dense Graded Plantmix) or 0.4 in. (Open-Graded Plantmix) from and parallel to the scribed line (See Figure 5).

PROCEDURE

At each prominent peak or high point (must grinds) of the profile trace, place the template so that the small holes at each end of the scribed line intersect the profile trace to form a chord across the base of the peak or indicated bump. The line on the template does not need to be longitudinal. With a sharp pen or pencil, draw a line using the narrow slot in the template as a guide. Any portion of the trace extending above this line will indicate the approximate length and height of the deviation in excess of the specification value. Do not subtract the 0.2 in. wide shaded area when measuring high points. There may be instances where the distance between easily recognizable low points is less than 1 in. (25 ft). For such cases, a shorter chord length shall be used in making the scribed line on the template tangent to the trace at the low points (See Figure 6). However, it is the intent of this requirement that the baseline for measuring the height of bumps will be as nearly 1 in. (25 ft) as possible, but in no case shall exceed this value. When the distance between prominent low points is greater than 1 in. (25 ft), make the ends of the scribed line intersect the profile trace when the template is in a near horizontal position. The location of any high point that exceeds specification limits for bump height should be marked on the pavement. The station of that bump must be recorded on Form No. 040-073 in the remarks section so that the bump can be located for possible remediation at a later date.

SECTION III – FIGURES

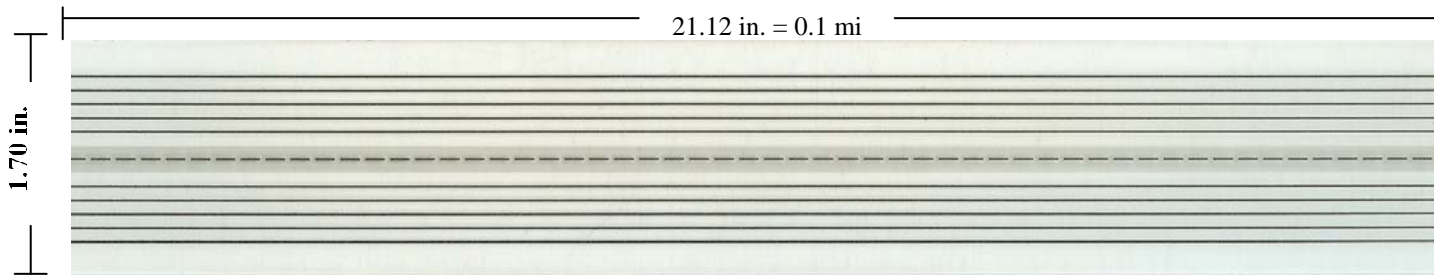

Figure 1: Plastic Scale (Blanking Band)

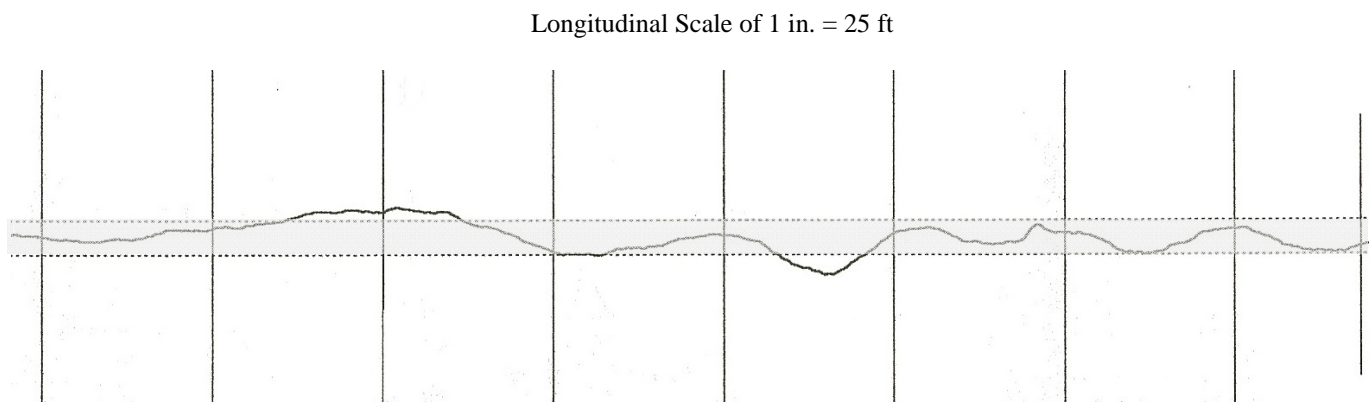

Figure 2: Balanced Blanking Band



Incorrect placement of blanking band for shifting profile



Figure 3: Correct placement of blanking band for shifting profile

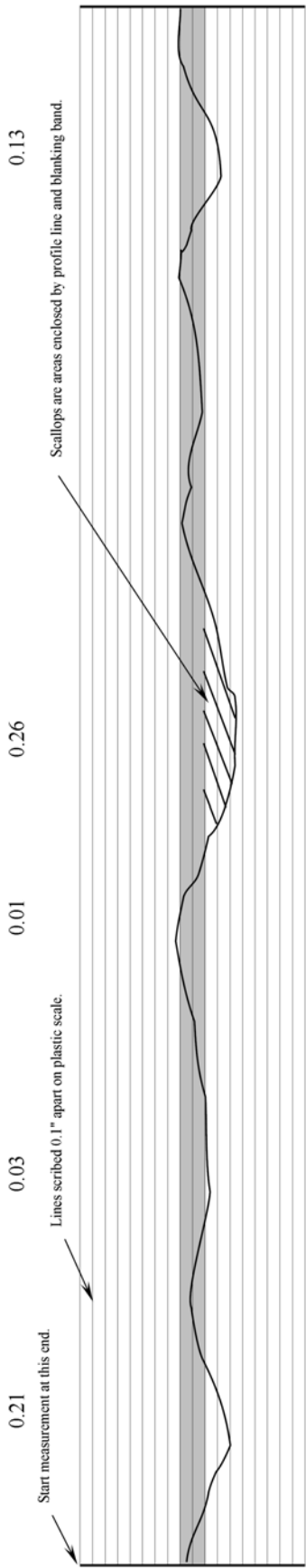

Total measurement for this 0.1 mi section is 0.64 tenths of an in.

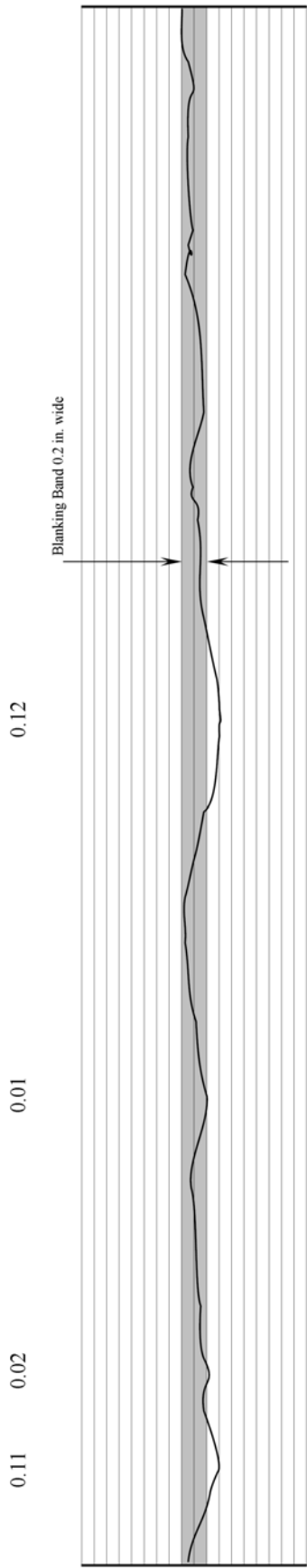

Total measurement for this 0.1 mi section is 0.26 tenths of an in.

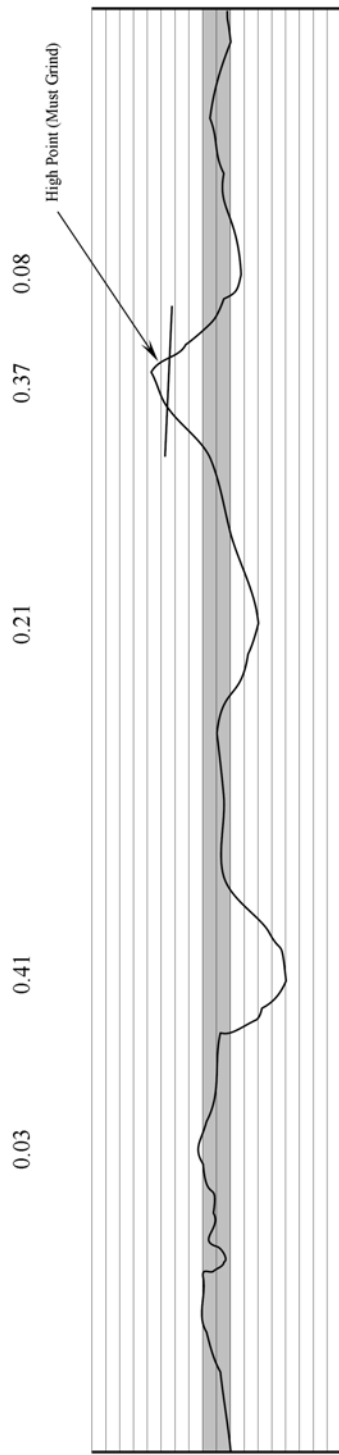

Total measurement for this 0.071 mi section is 1.55 tenths of an in. Total count must be based on 0.1 mile section. $.1/071 \times 1.1 = 1.55$

Figure 4: Typical 0.1 (tenth) mi sections

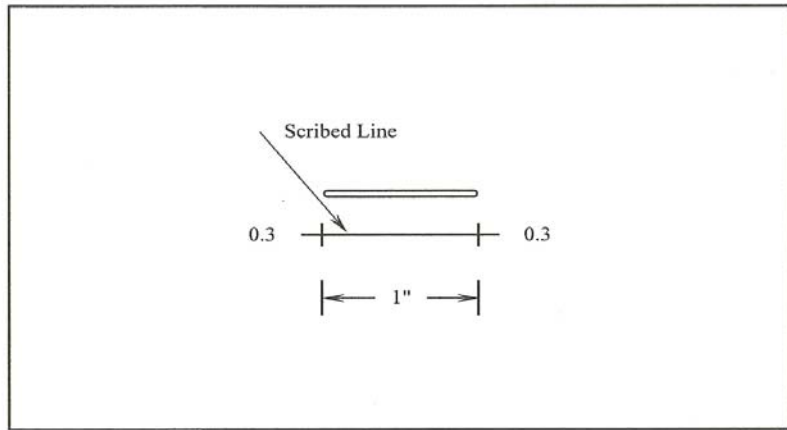

BUMP TEMPLATE

Figure 5: A typical 0.3 in. bump template

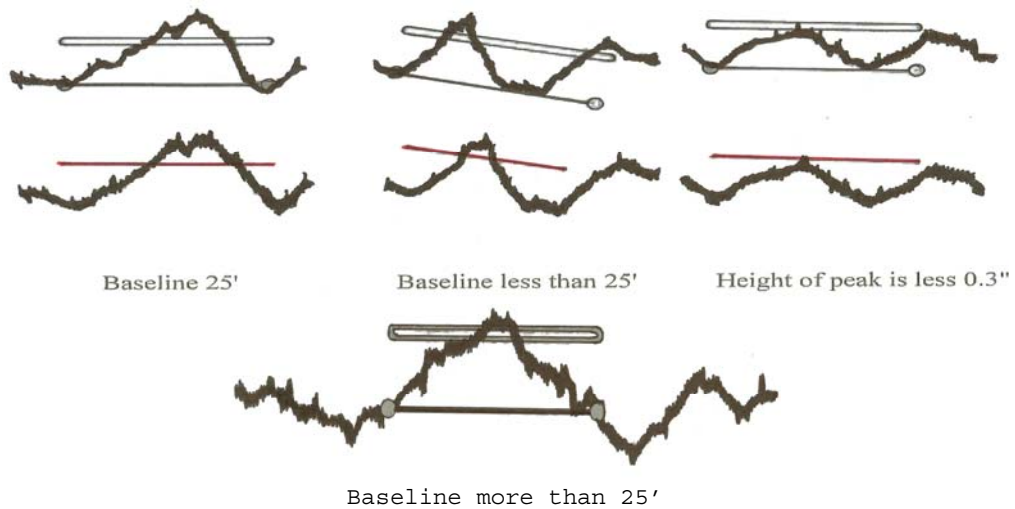

Figure 6: Bump template positions for varying conditions

Profiler System V1.53
Licensed to: Joe Contractor
Date Paved: 6/01/08 6:00 AM
Date Tested: 6/01/08 2:00 PM
File C:\My Documents\3400
1 Seg 1 Stn: 620 + 00 to 625 + 28
Height Cal – 109 counts in 1.00 in
Distance Cal – 119 counts per ft
Filter (Moving Average, Width = 1.90, Gain = 1.000)
Scallop:
 minimum height 0.01 in.
 minimum width (300:1) 2.00 ft
 resolution 0.01 in.
 blanking band 0.20 in.
 defect bump template height 0.40 in.
 defect bump template length 25.0 ft

 Track 1
PRI (in./mi/0.1mi) 0.00
No Defects Found: 0.00

Figure 7: Parameters for a California type profilograph



Figure 8: California type profilograph

State of Nevada
Department of Transportation
Materials Division

**METHOD OF TEST FOR EVALUATION OF PAVEMENT RIDE QUALITY USING INERTIAL
PROFILING SYSTEMS**

SCOPE

This test method describes the procedure used for determination and verification of the ride quality of a pavement surface using an inertial profiler and Mean Roughness Index (MRI) as the quality measure and by using the International Roughness Index (IRI) to determine Areas of Localized Roughness.

EQUIPMENT

Use an approved inertial profiling system that meets the requirements of the Standard Specifications for Road and Bridge Construction.

EQUIPMENT CALIBRATION

Inertial profilers need to be calibrated prior to each use as required by manufacturer's recommendations.

The Inertial profiler equipment and host vehicle should be warmed up in accordance with the manufacturer's recommendations before beginning the calibration tests. Tire pressures on the host vehicle should be inflated to the tire manufacturer's specifications.

The calibration and/or verification procedure may vary somewhat from manufacturer to manufacturer. Review the operator's manual for the inertial profiler that is furnished in order to become familiar with the actual procedure.

The following is a guideline of typical calibration and/or verification tests to be performed for inertial profilers:

1. Accelerometer Calibration:

The accelerometer calibration is performed by placing the inertial profiler on a relatively level surface and allowing the accelerometer or accelerometers to stabilize. Next, follow the steps as

directed by the profiler's operating system. The profiler's software will determine whether or not the calibration was successful.

2. Longitudinal Distance Calibration:

The longitudinal distance calibration is performed by operating the inertial profiler on a straight and relatively level section of the roadway measuring at least 528 feet or 0.100 mile in length. The actual length of the test section will be measured using a temperature-compensated steel survey measurement tape, electronic survey instrument or other method as approved by the Engineer. The distance shown by the inertial profiler's computer display shall be within 0.10 percent of the actual length of the test section. If the distance measured is out of specification tolerance, adjust the inertial profiler's distance measurement subsystem in accordance with the manufacturer's specifications and perform the calibration test again.

3. Vertical Height Verification:

The vertical height verification is performed by placing the inertial profiler on a relatively level surface and placing first, a reference plate or plates, then a series of blocks of known thickness under the vertical height sensor. The reference plate or plates and blocks shall be provided by the inertial profiler manufacturer. Unless otherwise directed by the profiler manufacturer, complete the vertical height calibration by performing the following steps:

- a) Position the reference plate under the height sensor or sensors of the inertial profiler and allow the system to determine an elevation for the reference plate. Check to see that the plate rests solidly on the pavement surface in a relatively level position without any wobble before obtaining measurements. The reference plate should have adjusting bolts to allow for leveling.
- b) Position a 0.250 in. thickness block on top of the reference plate in the laser path beneath the height sensor and allow the system to determine an elevation to the top of the block.
- c) Remove the 0.250 in. thickness block from the reference plate and replace with a 0.500 in. thickness block and allow the system to determine an elevation to the top of the block.
- d) Remove the 0.500 in. thickness block from the reference plate and replace with a 1.000 in. thickness block and allow the system to determine an elevation to the top of the block.
- e) Remove the 1.000 in. thickness block from the reference plate and replace with a 2.000 in. thickness block and allow the system to determine an elevation to the top of the block.

If the inertial profiler is equipped with multiple vertical height sensors, this test shall be repeated for each sensor. Multiple sensors may be tested simultaneously if the profiler is equipped with enough blocks and plates and the inertial profiler's operating system allows for it.

Determine the difference between each measurement of each size of block and the average of ten measurements of the elevation of the reference plate to determine the thickness of each block as determined by the inertial profiler. Determine the absolute values of the difference between the measured thickness and the block known thickness. The average of the absolute differences for each block shall be less than or equal to 0.010 in. If the average of the absolute differences for each block exceeds specification tolerance, adjust the inertial profiler's height measurement subsystem in accordance with the manufacturer's recommendations and perform the calibration test again.

4. Bounce Test:

The bounce test is performed by placing the inertial profiler in a relatively level area, ensuring that the surface being referenced is smooth and free of significant defects or irregularities. If a smooth surface is not obtainable, the reference plates as used for the vertical height verification may be placed under the height sensors. Initiate a data collection run using the inertial profiler's normal data collection software operating at a simulated travel speed equivalent to approximately the midpoint of the profiler manufacturer's recommended range for acceptable data collection. The simulated collection run will be performed over a simulated distance of 2,184 feet. Once the simulated collection run is initiated, allow the inertial profiler to collect a static profile over a simulated distance of 828 feet with the host vehicle as motionless as possible. Next, move the sensors approximately 1-2 in. vertically by gently "bouncing" the host vehicle up and down for a simulated distance of 528 feet. Every effort should be made to limit forward/backward movement of the vehicle and to keep the sensors as close to perpendicular as possible during the vertical movement. Finally, allow the host vehicle to return to a motionless state and collect a static profile for the remaining 828 feet of simulated distance.

Once the simulated run is completed, save and analyze the simulated collection data using the profiler software for each profile collected. Ensure that the static portions of the simulated run result in an IRI of less than 3.000 in./mile and the dynamic or bounce portion of the simulated run is less than 8.000 in./mile.

A log of the results for calibrations and verifications shall be kept with the inertial profiler and made available to the Engineer upon request.

METHOD OF MEASUREMENT

PREPARATION FOR MEASUREMENT

1. Prior to operating the inertial profiler, ensure the roadway is dry and free of any debris.
2. Locate and mark the location of any exception or leave out areas. Ensure that all exception or leave out areas are accounted for prior to beginning the measurement process.
3. Mark the location of the beginning of the lead-in section and the location of the beginning of the measurement run. A lead-in section length of roadway surface of up to 450 ft may be required to allow the filters on the inertial profiler to stabilize before measurement begins so that the accuracy of the first 0.100 mi is consistent with the rest of the measured section. The operator should carefully consider the safety of the starting location when marking the beginning of the lead-in section.
4. Mark the location of the end of the measurement run and the end of the lead-out section. A lead-out section length of roadway surface of up to 450 ft may be required to allow the operator of the inertial profiler to maintain a constant speed at the point where the measurement ends, so that the accuracy of the last 0.1000 mi is consistent with the rest of the measured section. The operator should carefully consider the ability to stop the inertial profiler safely when marking the end of the lead-out section.
5. Set Analysis Parameters to report in Mean Roughness Index (MRI).
6. Input the segment length to 528 ft or 0.100 mile
7. Input a reporting interval of less than or equal to 1.000 in. for each measurement run.
8. Input filter settings as “None”.
9. Set Localized Roughness to read bump and dip defect data in International Roughness (IRI) with the maximum threshold as determined by the Special Provisions and a base length of 25 ft.
10. Enable collection of Global Positioning System (GPS) data for each measurement run of the inertial profiler.
11. Input the beginning location of the measurement run.
12. Select appropriate “measure up” or “measure down” setting for distance measurement.

LIMITATION OF MEASUREMENT

1. When the new pavement surface elevation is the same as the existing pavement surface elevation, mark the beginning of the measured section at least 15 ft before the beginning of the new section of pavement and mark the end of measured section at least 15 ft past the end of new section of pavement. This measured section is intended to include the take-off and/or landing joints in the evaluation of ride quality.
2. When the new pavement surface elevation does not match the existing pavement surface elevation, mark the beginning of the measured section at least 15 ft past the beginning of the new section of pavement and mark the end of the measured section at least 15 ft before the end of the new section of pavement. This measurement is intended to exclude the takeoff and/or landing joints in evaluation of ride quality due to the disparity in elevation.

MEASUREMENT

1. Move the inertial profiler to the beginning of the measurement section.
2. Proceed with measurement as directed by the inertial profiler manufacturer. Measurement data shall be obtained in the same direction as the normal flow of traffic.
3. Measure Profiles within each traffic lane with the left or right side sensor path at 3 ft from and parallel to the respective left or right traffic lane line. The spacing between sensor paths shall be between 66 in. and 72 in.
4. Stop measurement at any exceptions or leave out areas. Resume measurement using the correct location as indicated on the other end of the exception or leave out area. Repeat this process as needed to complete the measurement run.
5. Re-measure any pavement segment where the travel speed of the profiler is outside of the manufacturer's recommended operational speed at any point during the measurement, or if any operator and/or equipment errors are encountered during the measurement process.
6. Upon completion of measurement run, move the inertial profiler to a safe location, then save any relevant data to a file using an approved unfiltered electronic format that can be easily retrieved for review and submittal. The profile data must be compatible with ProVAL Pavement Profile Viewing and Analysis software. ProVAL is produced by the Transtec Group in cooperation with the Federal Highway Administration and is available for download by going to <http://www.roadprofile.com/>.
7. Submit the saved profile data to the Engineer within 24 hours of the completion of the measurement.

8. Include the following within the submitted electronic profile data:
 - Raw profile data for each lane measured.
 - Ride quality analysis report of MRI for overall run of each lane measured.
 - Localized Roughness report for each wheel path of each lane measured.
 - GPS data file for each lane measured.
 - Current calibration and verification test results.

9. In addition to the electronic format file, a printout of the report of calibration for the profiler, the results of a measurement run and evaluation, and a printed summary report shall be provided to the Engineer within 24 hours of the completion of a measurement run. The printed report shall be in a .pdf format.

EVALUATION OF PROFILES

1. Evaluate the entire length of the profile measurement section for compliance with MRI requirements found in the Special Provisions for the pavement being measured with the following exceptions:
 - Do not evaluate any measurements obtained within the lead-in and lead-out sections.
 - Do not evaluate any measurements obtained within 15 ft of a cattleguard or some other break in the continuous pavement surface.
 - Do not evaluate any measurements obtained within 15 ft of a concrete bridge deck (including approach slabs) unless the bridge deck also is to be overlaid with a new riding surface.

EVALUATION FOR AREAS OF LOCALIZED ROUGHNESS

1. Analyze the submitted profile data to determine any areas of IRI - Localized Roughness in excess of specification tolerances found in the Special Provisions for the pavement surface being measured.
2. Create a summarized list of areas that are in excess of the limits for IRI – Localized Roughness. Upon request, submit the summarized list to the Contractor for their review and determination of the best method of correction for the defective areas.

REPORTING

1. The following information shall be submitted with the printed inertial profile report:
 - Name of data file.
 - Contract or Project No.
 - County.
 - Contractor.
 - Highway or route no.
 - Surface being tested.
 - Date of placement.
 - Date of testing.
 - Direction of traffic (northbound, eastbound, southbound, westbound).
 - Direction of placement (northbound, eastbound, southbound, westbound).
 - Lane designation (1, 2, 3...Inside, Outside, Middle, etc.).
 - Name of Tester.
 - Calibration results.
 - Filter settings.
 - Localized Roughness settings.
 - Summary Report of Mean Roughness Index for each 0.1 km (0.1 mi) segment.
 - Certification of the report by the profiler operator.
 - The title of the person certifying the report.

2. The following information shall be submitted with the report of any Areas of IRI - Localized Roughness Including:
 - A list of exception or leave out sections.
 - A list of any IRI - Localized Roughness defects in excess of specification limits.

3. Measurements are to be reported using project mileposts as appropriate. A list of project mileposts will be provided on the project plans.

4. Report the MRI and IRI in./mi to the nearest 0.001 in.

5. Report each 528 ft or 0.1 mi section to the nearest 0.001 mi.

NOTES

1. Review inertial profiler operating manual to familiarize yourself with the equipment that will be used.

State of Nevada
Department of Transportation
Materials and Testing Division

METHOD OF TEST FOR BULK SPECIFIC
GRAVITY (S.S.D.) AND ABSORPTION OF
COARSE AGGREGATE FOR CONCRETE

(FIELD METHOD)

SCOPE

This test method, which is a modification of AASHTO Designation T85, describes a rapid procedure used in the field for determining the bulk specific gravity (saturated surface dry condition) and absorption of coarse aggregate. The bulk specific gravity is the value desired for calculations in connection with portland cement concrete.

A. APPARATUS

1. A balance having a capacity of 20,000 grams and sensitive to 1 gram. A satisfactory balance is an "Ohaus" Metric Solution Balance.
2. A galvanized water pail of 12- to 14-quart (11.35 to 13.24 litres) sizes.
3. A suitable container for the immersion of the pail and sample in water. A 20-inch (508.0 mm) diameter garbage can about 24 inches (609.6 mm) high may be used.
4. A brass or galvanized rod about 3/16 inch (4.76 mm) in diameter with open hooks on each end. The rod should preferably be made in two detachable sections; the upper section is attached to the center of the balance pan and becomes part of the tare weight. This upper section is of such length that its lower end remains above the surface of the water in the container, and it is in a convenient position for attaching and removing the lower section from which the pail is suspended when weighing in water.
5. A bench or table to support the balance over the water container. Sufficient clearance between the table bottom and the top of the water container should be allowed to permit insertion of the pail into the water container. An opening shall be made in the bench to permit suspension of the hooked rod from the center of the balance pan.
6. A spoon, rod, or other suitable device for stirring and removing trapped air from the sample, when it is inundated in the pail. (The hand may be used if desired.)
7. A 3-square-yard (91.44 cm x 91.44 cm) piece of toweling.

B. PREPARATION OF SAMPLE

Select approximately a 4,000-gram sample representative of the coarse aggregate. If the sample is not visibly wet, cover with water at room temperature overnight.

C. PROCEDURE

1. Make all weighings to the nearest gram.
2. Water temperature in the container should be maintained between 65° and 75° F. (18.3° to 23.9° C.). Submerge the empty pail in the water container. Exercise care when immersing to see that no air is trapped under the pail. Adjust the water level in the container to intersect the straight portion of the lower section of the rod with the water surface. Adjust to this same water level (+ 1 inch) (25.4 mm) for all future "in water" weighings. Weigh and record as weight in water of pail and rod. Remove pail and lower hooked rod from water container.
3. After the test sample has absorbed overnight, pour off all excess water. Care should be taken to avoid any loss of aggregate particles.
4. Place the wet sample in the toweling, roll and pat to remove additional water. S.S.D. condition has been reached when all visible films of water are removed, although the surfaces of the particles may still appear to be damp. The larger fragments or particles may be individually wiped. Avoid as much as possible, evaporation of absorbed water during the operation of surface drying.
5. Place the sample (S.S.D.) on the balance and weigh immediately in air.
6. Remove the sample from the balance and place in the pail. Add enough water to the pail to completely inundate the sample. Stir the inundated sample with a spoon, rod or the hand in order to remove any air trapped between the aggregate particles.
7. Add enough water to almost fill the pail and attach the pail to the balance by means of the hook-ended rods. Lower and immerse the pail and sample into the water container and adjust the water level to within + 1 inch (25.4 mm) of the same reference level as determined in paragraph 2 above. Exercise care when immersing to see that no air is trapped under the pail. Weigh and record as weight in water of the pail, rod and sample.
8. The weight in water of the sample is equal to the weight in water of the pail, rod and sample minus the weight in water of the pail and rod.
9. Pour sample into suitable drying pan, dry sample to constant weight, cool to room temperature, pour sample into balance pan, use suitable tare weight and weigh to nearest gram. Record as dry weight for calculating the percent absorption.

D. CALCULATIONS

Bulk Specific Gravity

1. Calculate the bulk specific gravity (saturated surface-dry basis) from the following formula:

Bulk specific gravity (saturated surface-dry basis)=

$$\frac{W_a}{W_a - W_w}$$

Where:

W_a = Weight in grams, in air, of the sample in a saturated surface-dry condition, and

W_w = Weight in grams, in water, of the sample in a saturated condition.

2. Duplicate determinations should check to within ± 0.02 from the average specific gravity.

Absorption:

3. Calculate the absorption from the following formula:

$$\text{Percent absorption} = \frac{W_a - A}{A} \times 100$$

Where:

A = Weight in grams of the sample in dry condition.

W_a = Weight in grams, in air, of the sample in a saturated surface-dry condition.

4. Duplicate determinations should check to within ± 0.31 from the average percent absorption 95 percent of the time.

REFERENCE

AASHTO Designation T85
Test Method No. Calif. 224

State of Nevada
Department of Transportation
Materials Division

**METHOD OF TEST FOR BULK SPECIFIC GRAVITY AND ABSORPTION OF FINE
AGGREGATE**

SCOPE

This test method describes the procedure used for determining the bulk specific gravity (saturated surface-dry condition) and absorption of fine aggregate.

APPARATUS

1. Balance, having a capacity of 12,000 g and sensitive to 0.1 g.
2. Pycnometer (Figure 1), 1 L (1 qt) glass jar fitted with a conical lid having a small opening at the top of the cone.
3. Mold (Figure 1), conical metal mold 40 ± 3 mm ($1\frac{1}{2} \pm \frac{1}{8}$ in.) inside diameter at the top, 90 ± 3 mm ($3\frac{1}{2} \pm \frac{1}{8}$ in.) inside diameter at the bottom and 75 ± 3 mm ($3 \pm \frac{1}{8}$ in.) in height.
4. Tamper (Figure 1), metal tamper having a mass of 340 ± 15 g and having a flat circular tamping face 25 ± 3 mm ($1 \pm \frac{1}{8}$ in.) in diameter.
5. Rubberized Cloth (Figure 1), approximately 0.9 x 0.9 m (3 x 3 ft).
6. Electric Fan or hair dryer (Figure 1) (both optional).
7. Container (Figure 1), 12" mold with lid or 5 gal. bucket with lid
8. Oven, capable of maintaining a temperature of $110 \pm 5^{\circ}$ C ($230 \pm 9^{\circ}$ F)

SAMPLE PREPARATION

1. Obtain a representative sample per Test Method Nev. T200.
2. Obtain approximately 1,200 g representative portion of the sample per Test Method Nev. T203.
3. Dry the representative sample per Test Method Nev. T112.
4. Add 4.5 % water to the dry representative sample, thoroughly mix and soak in a sealed container for 15 to 24 hours.

PROCEDURE

1. Record the weight of the pycnometer filled to its calibration level with water between $25 \pm 5^{\circ}\text{C}$ ($77 \pm 9^{\circ}\text{F}$), to the nearest 0.1 g.
2. Partially fill the pycnometer with water. Water temperature in the pycnometer should be maintained between $25 \pm 5^{\circ}\text{C}$ ($77 \pm 9^{\circ}\text{F}$).
3. Decant excess water from the fine aggregate sealed sample container, take care to avoid loss of fines. Spread the fine aggregate on a flat non-absorbent surface (rubberized cloth) and stir frequently to ensure homogeneous drying. If desired, mechanical aids such as tumbling, stirring, an electric fan or a hair dryer may be employed to assist in achieving the saturated surface-dry condition. As the fine aggregate begins to dry sufficiently, it may be necessary to work it with the hands in a rubbing motion to break up any conglomerations, lumps or balls of material that develop. Continue this operation until the fine aggregate approaches a free flowing condition.

Follow the Cone Test for Surface Moisture, as shown below, to determine whether or not surface moisture is present on the fine aggregate particles. The first trial of the cone test will be performed at a moisture content above the saturated surface-dry condition. Continue drying with constant stirring, and if necessary, work the fine aggregate with a hand rubbing motion, and test at frequent intervals until the test indicates that a saturated surface-dry condition has been reached. If the first trial of the surface moisture test indicates that moisture is not present on the surface, it has been dried past the saturated surface-dry condition. In this case, thoroughly mix a few milliliters of water with the fine aggregate and permit it to stand in a sealed container for 30 minutes. Resume the process of drying and testing at frequent intervals, until a saturated surface-dry condition is achieved.

Cone Test for Surface Moisture – Hold the mold firmly on a smooth nonabsorbent surface (rubberized cloth) with the large diameter down. Place a portion of the partially dried fine aggregate loosely in the mold by filling until overflow occurs and heaping additional fine aggregate above the top of the mold by holding it with the cupped fingers of the hand holding the mold. Lightly tamp the fine aggregate into the mold with 25 light drops of the tamper (cup fingers around the top edge of the mold to prevent damage to mold). Each drop should start about 5 mm (0.2 in.) above the top surface of the fine aggregate. The tamping force shall not be more than that applied by the weight of the tamping rod. Adjust the starting height to the new surface elevation after each drop and distribute the drops over the surface. Do not add additional fine aggregate after the tamping is completed. Remove loose sand from around the base and lift the mold vertically. If surface moisture is still present, the fine aggregate will retain the molded shape. When the fine aggregate slumps slightly, it indicates that it has reached a saturated surface-dry condition.

4. Remove one 500 ± 0.2 g portion of fine aggregate from the saturated surface-dry sample and dry to a constant weight per Test Method Nev. T112, cool sample and record “Weight of sample in oven-dry condition” (A), to the nearest 0.1 g.

5. Take another 500 ± 0.2 g portion of the remaining saturated surface-dry fine aggregate and place into the pycnometer. Record the "Weight of sample in saturated surface-dry condition" (B), to the nearest 0.1 g. Fill with additional water to approximately 90 percent of capacity. Manually roll, invert, and agitate the pycnometer to eliminate all air bubbles. Fill the pycnometer to its calibrated level with water between $25 \pm 5^\circ\text{C}$ ($77 \pm 9^\circ\text{F}$).

NOTE: It takes approximately 15 to 20 minutes to eliminate air bubbles. It has been found useful to dip the tip of a paper towel into the pycnometer to help in dispersing the foam that sometimes builds up when eliminating the air bubbles or adding a few drops of isopropyl alcohol after removal of air bubbles and just prior to bringing the water to its calibrated level.

6. Record the weight of the pycnometer with fine aggregate and water filled to calibration level as "Weight of sample immersed in water" (C), to the nearest 0.1 g.

CALCULATIONS

1. Calculate bulk specific gravity (saturated surface-dry basis) as follows:

$$\text{Bulk specific gravity (saturated surface-dry basis)} = A / (B - C)$$

A = Weight of sample in oven-dry condition

B = Weight of sample in saturated surface-dry condition

C = Weight of saturated sample immersed in water

2. Calculate the percentage of absorption as follows:

$$\text{Absorption, percent} = [(B - A) / A] \times 100$$

A = Weight of sample in oven-dry condition

B = Weight of sample in saturated surface-dry condition

REPORT

Report results of specific gravity to the nearest 0.01 and absorption to the nearest 0.1 percent.

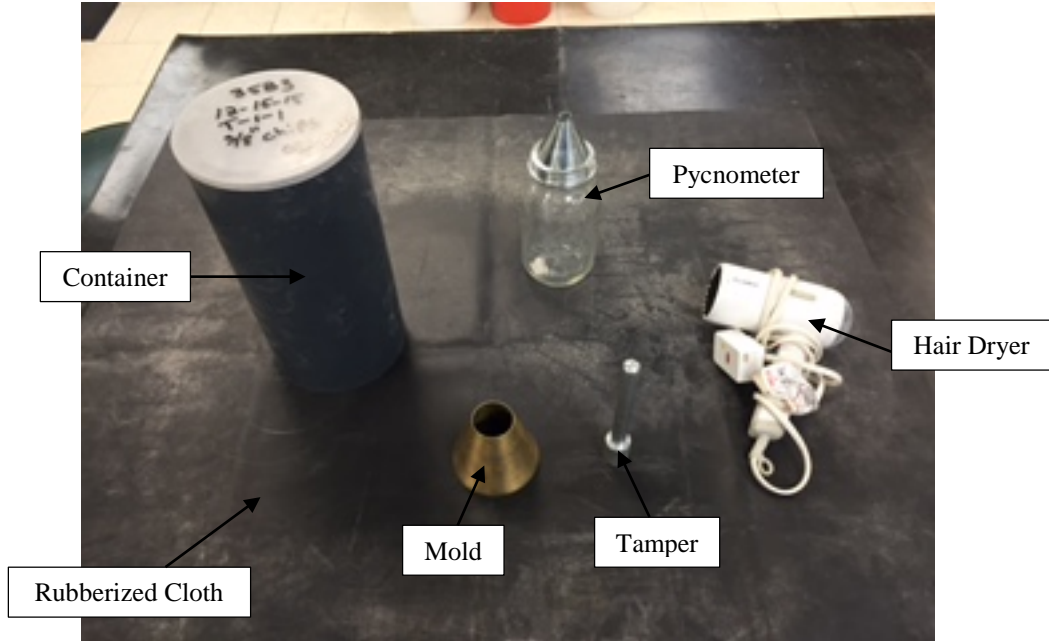

Figure 1

State of Nevada
Department of Transportation
Materials Division

METHOD FOR DETERMINATION OF DRY FILM
THICKNESS OF EPOXY OR WATERBORNE
PAVEMENT MARKING MATERIALS

SCOPE

This test method is an adaptation of ASTM D 1005-95, and covers the measurement of dried film thickness of pavement marking materials using hand-held micrometers.

APPARATUS

The measuring apparatus shall consist of a hand-held anvil type micrometer. The anvils of the micrometer shall be circular and approximately 1/4 in. (6 mm) in diameter, with flat bottoms. The micrometer shall have a resolution of at least 0.0001", 0.1 mil (0.0025 mm, 2.5 micron).

Test panel made of aluminum with dimensions of approximately 3" x 12" x 0.075" (75mm x 300mm x 2mm). Obtain the panels from the District Progress Labs.

Black permanent marker (Sharpie)

PROCEDURE

Follow the manufacturers recommendations for the initial setup and operation of the micrometer. Prior to making any measurements, verify the data display reads 0 when anvils are fully closed.

Using the marker, outline the area of the plate to be covered by striping material on the back of the test panel. Then mark and sequentially number 6 evenly spaced points in a grid pattern within the area enclosed by the outlined limits. Measure the plate thickness using the micrometer at each location and record the measured thickness value on the plate next to the corresponding numbered location.

Secure the aluminum test panel to the pavement just prior to the application of the striping material, perpendicular to the striping line at the designated sample location with the numbered points and thickness values facing down. Align the plate so the approximate area of material outlined above will match the actual application. Use duct tape to secure each end of the panel to the pavement, keeping the tape away from the area of the plate that will receive the paint.

Note: Paint thickness is determined on samples without reflective beads. Ensure that the striping vehicle operator sees the plate and stops the application of beads prior to passing over the test panel.

Once the striping applicator has passed and applied the striping material to the plate, allow the material to sufficiently dry so that the paint will not run or smear. Remove the test panel from the roadway. The panel should be placed in a location that allows the paint material to further dry and be protected from damage during transportation back to the field office or to the location where the thickness measurements will be taken.

MEASURING PROCEDURE

Using the micrometer, measure the thickness of the test panel and paint material at each of the 6 areas previously marked and measured. Record the results on the plate next to the corresponding point with the permanent marker. Subtract the two values recorded at each point and then average the results of each of the 6 locations to determine the overall paint thickness. Record the average overall paint thickness to the nearest mil or micron on Form # 040-021.

Conversion: 1 mil = 0.001 inch
 1 micron = 0.001 mm

Example: Plate Thickness: Micrometer Reading = 0.07670 in
 Paint and Plate Thickness: Micrometer Reading = 0.09570 in

Paint and Plate Thickness – Plate Thickness = 0.019 in

$0.019\text{in} / 0.001\text{inches per mil} = 19 \text{ mil}$

Paint Thickness = 19 mil**

** Average with the 5 remaining values to determine reported value for paint thickness.

Refer to Section 632 of the contract specifications for minimum thickness values.

State of Nevada
Department of Transportation
Materials Division

**METHOD OF TEST FOR DETERMINING RETROREFLECTIVE PROPERTIES
FOR PAVEMENT STRIPING**

SCOPE

This method describes the procedure used for determining the minimum retroreflective properties for temporary and permanent applied waterborne, epoxy, and polyurea painted pavement striping.

EQUIPMENT

Use an approved retroreflectometer from NDOT's Qualified Products List (QPL). Retroreflectometers need to be calibrated and serviced by the manufacturer every two years and calibrated prior to each use as required by manufacturers recommendations.

METHOD OF MEASUREMENT

1. Prior to taking retroreflectivity readings, the roadway shall be dry and free from any debris.
2. Take retroreflective measurements one to two weeks after installation of pavement striping.
3. Measurement locations will be randomly determined by the Engineer.
4. Test frequencies will be in accordance with the "Testing Frequency Schedule - **Minimum** Required Samples and Tests - Project".
5. All measurements will be taken in the direction of traffic flow, except on the centerline of two-lane roads where the required number of measurements will be made in each direction. Both single and double lines are to be measured and the acceptance criteria shall be followed for each line in both directions.
6. One test location is defined as taking the average of five readings, approximately 3 m (10 ft.) apart. If the average of five readings meet specifications, then record the average on Form No. 040-041 (Retroreflectivity Measurements). If the average of the five readings is below the required retroreflectivity requirement, take the average of three additional readings, which are outside of the original five readings, to verify retroreflectivity failure. If the average of the additional three readings still do not meet specification requirements, then record the average of the five original readings and the average of the three additional readings on Form No. 040-041 (Retroreflectivity Measurements). This procedure will complete one test location.

For example, if you have a two-lane roadway, there would be three stripes total - two edge stripes, and a centerline stripe. (See Standard Specifications and Special Provisions for project retroreflectivity requirements).

REPORTING:

1. Form No. 040-041
2. Date Tested
3. Date and Time of Pavement Marking Application
4. Station of Test
5. Description of Equipment Used
6. Equipment Calibration / Service Date
7. Material Description - epoxy, waterborne, polyurea, etc.
8. Line Type - skip, solid, double solid, skip w/solid, etc.
9. Color of Stripe
10. Retroreflectivity Measurements
11. Specification Requirement

NOTES:

1. One test location per lane kilometer or three test locations per lane mile per stripe are required.
2. Centerline stripes must be tested in each direction as results may vary.
3. Review Retroreflectometer Operating Manual to familiarize yourself with the equipment that will be used.

State of Nevada
Department of Transportation
Materials Division

METHOD OF TEST FOR PAVEMENT MARKING FILM ADHESION

SCOPE

This method describes the procedure used for determining the minimum adhesion for pavement marking film.

APPARATUS

1. Scale, 13.6 kg (30 lb) minimum capacity, accurate to the nearest .02 kg (oz).
2. Clamp, any suitable device that will attach to the scale and sufficiently clamp and hold the pavement marking film firmly in place.

PROCEDURE

1. Prior to taking adhesion measurements, the roadway shall be dry and free from any debris.
2. Adhesion measurements will be taken within the time limits specified in the Standard Specifications and Special Provisions.
3. Measurement locations will be randomly determined by the Engineer.
4. Test frequencies will be in accordance with the "Testing Frequency Schedule - Minimum Required Samples and Tests - Project".
5. Both single and double lines are to be measured and the acceptance criteria shall be followed for each line. Miscellaneous markings such as arrows, onlays, crosswalks, stopbars, etc. will be at the discretion of the Engineer.
6. Randomly select area to be measured. Avoid testing the first and last 100 mm (4 in.) of any stripe. Cut a 25 mm (1 in.) strip transversely through the material. Lift approximately 25 mm (1 in.) of the strip material from the substrata to enable gripping in the clamp, which is attached to a spring-loaded scale (see Figures 1 and 2). Once the scale and clamp are attached to the end of the 25 mm (1 in.) strip, continue to pull until the remaining test strip begins to separate from the substrata. The material shall resist the minimum pull applied at an angle of 90° relative to the surface of the adhered marking film strip. (Refer to Section 634 of the Standard Specifications and Special Provisions for minimum adhesion requirements). If the material does not meet the minimum requirements, randomly select another location, which is within the original area represented by that test, and repeat

this procedure. If the second test passes, the area represented by that test will be accepted. If the second test fails, the area represented fails to meet minimum requirements.

CALCULATIONS

If using a metric scale in kilograms, the following formula shall apply:

$$\text{kilograms} \times 9.81 = N$$

REPORT

Report adhesion results to the nearest N (lb)

Typical 100 mm (4 in.) Pavement Marking Film Application

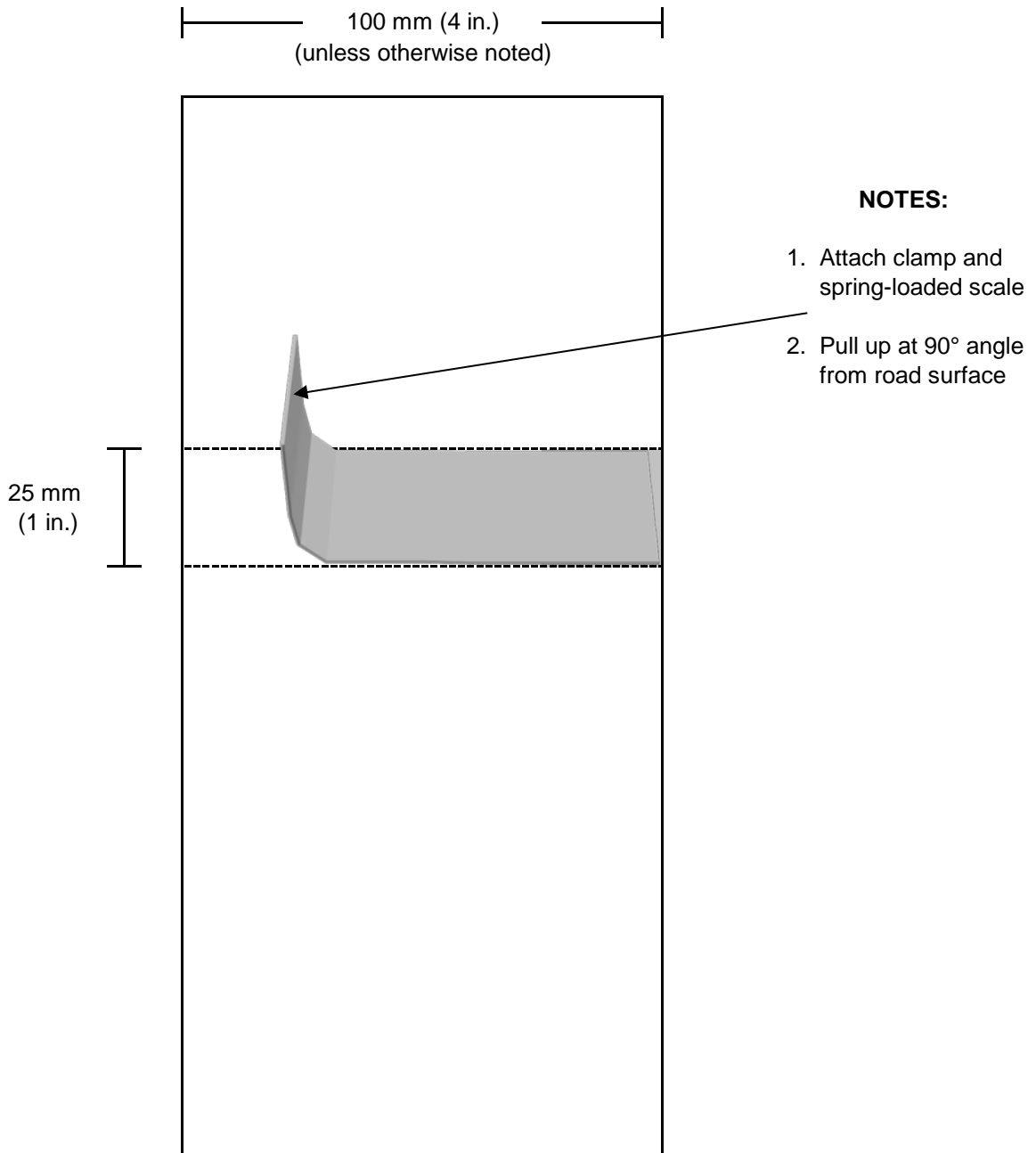

Figure 1



Figure 2

State of Nevada
Department of Transportation
Materials Division

METHOD OF TEST FOR SAMPLING BITUMINOUS MATERIAL

SCOPE

This method applies to sampling bituminous materials at the point of manufacture, storage, or delivery. Samples may be taken from tanks, vehicles, or containers used for storage or shipping of bituminous materials.

SIGNIFICANCE

Sampling is as important as testing and every precaution shall be taken to obtain samples that will show the true nature and condition of the materials. Samples are taken to represent an average of the bulk of the materials sampled.

SELECTION OF SAMPLES

Samples shall be taken in accordance with Section 106.04 of the Standard Specifications.

SIZE OF SAMPLES

The sample size of asphalt cement and liquid asphalt refinery samples submitted for mix designs shall be as specified in Section 401.02.02 of the Standard Specifications. The sample size of emulsified asphalt refinery samples submitted for pre-approval shall be 3.75 L (1 gal). The sample size of asphalt cement, liquid asphalt, and emulsion samples submitted for acceptance testing shall be 1 L (1 qt), unless otherwise specified. Sample containers shall be filled to within 25 to 50 mm (1 to 2 in.) of the top of the container.

CONTAINERS

1. Asphalt Cements - Wide mouth metal paint-can type containers.
2. Liquid Asphalts (MC-70, MC-250, MC-800, SC-800, etc.) - Metal cans with screw caps having an inside diameter of approximately 45 mm (1 3/4 in.).
3. Emulsified Asphalts - Wide mouth plastic bottles with screw caps.

PROTECTION AND PRESERVATION OF SAMPLES

1. All sample containers shall be new, clean and dry. Sample containers shall not be washed or rinsed with solvents. Sample containers shall not be wiped with an oily or solvent-saturated cloth. Do not use sample containers if they contain evidence of solder flux.
2. Immediately after filling, the lid shall be tightly affixed to the container. Care shall be taken to prevent contamination of samples by solvents, other types of bituminous materials, water, dust, or any other substance foreign to the material being sampled.
3. The filled sample container shall not be submerged in solvent, nor shall it be wiped with a solvent-saturated cloth. If cleaning is necessary, use a clean dry cloth.
4. Samples of emulsions shall be protected from freezing.
5. Transferring samples from one container to another shall not be permitted except where required by the sampling procedure. Characteristics of materials could be altered during transfer. Contamination is also a possibility.
6. After filling, installing the lids, and cleaning the containers (if necessary), the transmittal shall be completely and legibly filled out, signed, and affixed to the sample container. All samples will use the Transmittal for Asphalt Samples, NDOT Form No. 020-016. Masking tape shall be used to affix the transmittal to the container. Hot samples should be allowed to cool sufficiently before affixing the transmittal so that the tape will not melt to the can. In case of inclement weather, the transmittal will be sealed in a plastic envelope for protection. Strapping (fiber) tape, scotch tape, or duct tape should not be used for this purpose as they can damage the transmittal upon removal from the container.
7. Samples of all bituminous materials shall be forwarded to the Materials Division for testing as soon as possible.

SAMPLING PROCEDURES

Sampling will be performed by the contractor, asphalt supplier, shipper, or their representative. NDOT personnel should observe the procedure to ensure conformance to this specification. Sample containers will be provided by NDOT.

Sampling from a sample valve in a storage tank, vehicle tank, railroad tank car, or distributor truck:

1. Sample valves shall conform to AASHTO T 40.
2. Sample valves shall provide a sample from the approximate midpoint of the load.
3. Before the sample is taken, approximately 4 L (1 gal) of material will be drawn from the valve and discarded in order to ensure a representative sample.

Sampling from transfer lines:

1. Sampling will be accomplished by bleeding through a sample valve or drain-cock in the transfer line.
2. Sample valves shall conform to AASHTO T 40.
3. Before the sample is taken, approximately 4 L (1 gal) of material will be drawn from the valve and discarded in order to ensure a representative sample.
4. If sampling a vehicle tank during the unloading process, take the sample after one-third of the load has been removed and before two-thirds of the load has been removed.
5. A detachable fitting, containing a sampling valve, may be used on the truck outlet in front of the discharge. When the detachable fitting is used continuously for sampling the same product, it shall be allowed to drain between shipments while being protected from dust or accumulation of dirt, but shall not be cleaned with solvents. Threads of the collar and opposite end of the fitting shall be wiped clean with a cloth while the metal is warm and the bituminous material is still in a liquid condition. When the detachable fitting is used alternately for the sampling of different products, it shall be washed thoroughly with an appropriate solvent, followed by a second wash with an appropriate volatile solvent. The volatile solvent shall be removed by a warm air current or by drying in an oven before the next sampling.

Sampling from a bituminous hot-plant:

1. Sampling will be accomplished by bleeding through a sample valve or drain-cock in the transfer line.
2. Sample valves shall conform to AASHTO T 40.
3. Before the sample is taken, approximately 4 L (1 gal) of material will be drawn from the valve and discarded in order to ensure a representative sample.
4. Sampling will conform to the requirements of Section 106.04 of the Standard Specifications.

Sampling by the dip method:

1. This method is not suitable for asphalt cements.
2. Samples will be taken with an NDOT approved sampling device.
3. Samples shall be taken from the approximate midpoint of the load by lowering the approved sampling device into the bituminous material and opening the device at the appropriate level.
4. After sampling, the bituminous material will be transferred to an appropriate container as specified in the CONTAINERS section above.
5. The contractor, supplier, shipper, or their representative shall provide, handle and clean the sampling device. The Department will accept no responsibility for the cleanliness of the sampling device or for the representative nature of the sample.

6. A separate sampling device shall be provided for each delivery truck or trailer that is not equipped with a sampling valve.
7. Waste material, solvents, and residues from cleaning sampling devices shall not be deposited on state property.

Sampling by the spray bar method:

1. This method may be used for emulsions and liquid asphalts when it is not feasible to sample with a sample valve.
2. Samples shall be taken from a nozzle in the spray bar following complete circulation of the material. Take the sample after one-third of the load has been removed and before two-thirds of the load has been removed.

State of Nevada
Department of Transportation
Materials Division

**METHOD OF TEST FOR RELATIVE COMPACTION OF PLANTMIX BITUMINOUS SURFACE
AND COLD IN PLACE RECYCLE USING CONTROL STRIPS AND TEST SECTIONS
WITH A NUCLEAR DENSITY GAUGE**

SCOPE

This test method is designed to measure the degree of compaction of plantmix surface using a portable nuclear density testing device. Results may be obtained rapidly during the compaction process, allowing time for additional compactive effort if required.

APPARATUS

1. Thin Layer Density Gauge, Troxler Model 4640-B or 3450.
2. Magnesium reference block.
3. Air gap spacer.

STANDARDIZATION

1. Warm up period: Turn the thin layer density gauge on and warm up for ten minutes. This allows the regulators and deflectors to stabilize.
2. At the start of each shift, standardize the thin layer density gauge to check equipment operation. This procedure can also be used as an operational check whenever test measurements are suspect.
3. The site chosen for standardization should remain the same throughout the contract. Outline the magnesium reference block with keil (lumber crayon) to ensure the same location is used.
4. Place the magnesium reference block on a solid surface having a density of 1600 kg/m^3 (100 lb/ft^3) or greater, preferably a plantmix or concrete surface approximately 10 cm (4 in.) thick. Ensure that the magnesium reference block is level and does not rock back and forth. This location should be at least 3 m (10 ft) away from any large object such as a vehicle, field lab, wall or any water source and at least 9 m (30 ft) from any other nuclear gauge.

5. Place the air gap spacer on the magnesium reference block and then place the thin layer density gauge on top of the air gap spacer. The handle end of the gauge should rest over the two posts on the air gap spacer. Verify that the “standard mode” is in multi-standard mode.
6. With the lock attached and the handle in the safe position, press the “STANDARD” key on the keypad. The screen will display “Standard Count XXXX XXXX Take a new standard count?” Press the “YES” key. The screen will then show “Place gauge on spacer and both on block, put the rod in safe position, press enter.” Check to make sure the thin layer density gauge does not rock, then press the “START/ENTER” key. The thin layer density gauge will begin taking a four minute standard count.
7. When counting stops, at the end of the four minutes, screen will display “Standard # 1 XXXX X.XX% Pass Standard # 2 XXXX X.XX% Pass Use new standards?” If it shows a PASS/PASS, record the Standard #1 and Standard #2 in the gauge log book. Press the “YES” key. If you receive a PASS/PASS to the right of the percentages, it indicates that the standard counts are within the 1% maximum allowed variation for System 1 reference standard counts and 1.2% maximum allowed variation for System 2 standard counts.
8. If the standard counts for System 1 or System 2 fail, the screen will display “Do you want to use the new STD?” Press the “YES” key. Check the thin layer density gauge to make sure that the magnesium reference block does not rock, no other gauges are in the area and that the standard mode is in multi-standard mode. Then take another standard count.
9. It may take up to five standard counts before obtaining a PASS/PASS result. In the event that a PASS/PASS result is not obtainable, contact the Independent Assurance Lab for further assistance

CONTROL STRIP

Control strips are to be rolled with specified rolling equipment until "no appreciable gain of 1.0 lb or less in density is obtained by additional roller coverage's". Do not allow excessive rolling as this may result in cracking or other damage to the mat. In order to determine the number of roller passes required, density tests are made after each pass (one pass equals down and back) of the rollers at three (3) preselected locations. The average density for the three (3) locations is plotted on a chart of density versus number of roller passes. Rolling is discontinued when the curve levels off, and/or by an appreciable gain of 1.0 lb. Tests are then taken at seven (7) additional locations throughout the control strip. The average density at these ten test locations is the Mean Control Strip Density.

1. Tests during rolling
 - a. In order to assure that material throughout the entire control strip is effectively represented, divide the control strip (350 m^2 (400 yd^2)) into three (3) subsections of equal length, taking density tests diagonally across the mat. Select the site for testing. Mark the outline of the gauge on the material being compacted so that the gauge may be returned to the same spot after each roller pass (one pass equals down and back). Take the one-minute density test and record the results on NDOT form 040-048, TESTS DURING ROLLING. Rotate the gauge 180 degrees about its center and take the second one-minute density test and record the result on NDOT form 040-048, TESTS

DURING ROLLING. After each pass of the roller (at the three site locations), average the three “Average Test Site Density” values, and plot on NDOT form 040-048, Density Plot. See Figure 2 for an example. Repeat this process until "no appreciable gain of 1.0 lb or less in density is obtained by additional roller coverage". Do not allow excessive rolling as this may result in cracking or other damage to the mat. Repeat this process for each roller that will be utilized in this control strip.

2. After the rolling pattern has been established.
 - a. Take seven additional Average Test Site Density tests at various locations chosen at random throughout the established control strip. Average these seven Average Test Site Density results together with the three Average Test Site Density tests taken after the maximum number of roller passes, and record this average as the Mean Control Strip Density on NDOT form 040-048. Refer to Figure 3 for an example.
 - b. This control strip “Mean Control Strip Density” shall be used for the next ten test sections unless one of the following occurs:
 1. A new control strip shall be constructed, at the beginning of work on each lift of each roadway course, every twenty test sections, if results from compaction tests become erratic or significant change in composition of material.
 2. The maximum number of roller passes shall be noted on NDOT form 040-048 under Rolling Pattern, for each control strip. See Figure 3 for an example.

PROCEDURE (3450 or 4640-B SERIES GAUGES)

1. Determine the target density per Test Method Nev. T750 and enter the value into the thin layer density gauge. After completion of the desired roller coverage, a series of material density tests are to be taken at locations according to the following:
2. Test Sections
 - a. Divide the test section into five subsections of equal length. Four one minute mat density tests are to be taken for each subsection. If a joint or joints are present, two or four one minute joint density tests are to be taken. Refer to the Standard Specifications for the required size of the test sections.

The exact station at which the mat densities will be taken, is determined from the table of random numbers by multiplying a random number (column A) times the length of each subsection, rounded to the nearest 10 m (25 ft).

The exact distance in from the edge of the mat where the mat densities will be taken is determined from the table of random numbers (column B) times the width of the mat, rounded to the nearest 0.3 m (1 ft) for the distance in from the edge of the mat. **NOTE:** Do not take the mat density test any closer than 0.3 m (1 ft) from the edge of the mat.

The first four (4) one minute tests (rotated 90 degrees) are to be taken in each subsection. If the mat was inlaid, perform two (2) one minute joint tests on each joint within 0.15 m (6 in.) of the joint (rotated 180 degrees) at the same station as determined in column A.

b. Random numbers are always used in a series of ten, five from column A and five from column B. Any random number block may be used as long as a different block is selected for each new test section. The same random number block shall not be used in the same shift.

EX. Random Number Block = 15 Width of the entire mat = 13.8 ft
 Beginning Station "X" 413 + 12 Ending Station "X" 350 + 95

$$("X" 413 + 12) - ("X" 350 + 95) = 6217 \text{ ft}$$

$$6217 \text{ ft (length of test section)} / 5 \text{ (total subsections)} = 1243.4 \text{ ft (length of each subsection)}$$

Station – Length of Subsection = Station to Station for each Subsection

$$("X" 413 + 12.0) - 1243.4 = "X" 400 + 68.6$$

$$("X" 400 + 68.6) - 1243.4 = "X" 388 + 25.2$$

$$("X" 388 + 25.2) - 1243.4 = "X" 375 + 81.8$$

$$("X" 375 + 81.8) - 1243.4 = "X" 363 + 38.4$$

$$("X" 363 + 38.4) - 1243.4 = "X" 350 + 95$$

Column A x Subsection Length = Distance for each Subsection Test Station

.698	1243.4	867.9
.796	1243.4	989.7
.348	1243.4	432.7
.358	1243.4	445.1
.698	1243.4	867.9

$$("X" 413+12.0) - 867.9 = "X" 404+44.1 \text{ rounded to nearest 10 m (25 ft)} = "X" 404+50$$

$$("X" 400+68.6) - 989.7 = "X" 390+78.9 \text{ rounded to nearest 10 m (25 ft)} = "X" 390+75$$

$$("X" 388+25.2) - 432.7 = "X" 383+92.5 \text{ rounded to nearest 10 m (25 ft)} = "X" 384+00$$

$$("X" 375+81.8) - 445.1 = "X" 371+36.7 \text{ rounded to nearest 10 m (25 ft)} = "X" 371+25$$

$$("X" 363+38.4) - 867.9 = "X" 354+70.5 \text{ rounded to nearest 10 m (25 ft)} = "X" 354+75$$

Column B x Mat Width = Distance in from edge of Mat = Rounded to nearest .5 m (1 ft)

.683	13.8	9.4	9.0
.996	13.8	13.7	13.0 (mat is only 13.8)
.743	13.8	10.3	10.0
.595	13.8	8.2	8.0
.539	13.8	7.4	7.0

1st density test is at "X" 404 + 50, 9.0 ft in from edge of mat

2nd density test is at "X" 390 + 75, 13.0 ft in from edge of mat

3rd density test is at "X" 384 + 00, 10.0 ft in from edge of mat

4th density test is at "X" 371 + 25, 8.0 ft in from edge of mat

5th density test is at "X" 354 + 75, 7.0 ft in from edge of mat

3. Density Testing

- a. Program the target density from Test Method Nev. T324 or T750 into the thin layer density gauge. Input the target density for the Marshall and Voidless parameters into the thin layer density gauge. Select the “MA/VOIDLESS” key. The screen will display “MA: XXX.X pcf VD: XXX.X Do you want to change?” Press the “YES” key. Screen will display “Marshall XXX.X pcf ” Input the target density and press the “START/ENTER” key. Screen will display “Voidless Density XXX.X pcf.” Input the same target density and press the “START/ENTER” key. Thin layer density gauge will then go back to the main screen.
- b. Select the proper depth by pressing the “THICK” key. The screen will display “Layer Thickness: X.XX in. Input and Press Enter.” NOTE: Set the depth for the thin layer density gauge at 6 mm (0.25 in.) less than what is being placed. (EX. Paving 3 in. set the thin layer density gauge thickness at 2.75 in.) Thin layer density gauge will then go back to the main screen.
- c. Set the count time for 1 minute by pressing the “TIME” key. The screen will show “Count Time XX min. Do you want to change?” Press the “YES” key. The screen will show “Sel: 1 – 0.5 min. 2 – 1 min. 3 – 2 min. 4 – 4 min.” Press 2 for the 1 minute count time. Thin layer density gauge will then go back to the main screen. The 1 minute test is the only “TIME” allowed for density testing.
- d. Do not utilize the “Average” function, verify that the average function is set at 1. The average of the 4 tests shall be hand calculated.
- e. At each predetermined test site, place the thin layer density gauge on the mat. Check for rocking by placing a hand on opposite corners of the base. Outline the base of the thin layer density gauge with a piece of keil (lumber crayon). Place the source rod in the “Measure” position and press the “START/ENTER” key. At the end of the 1 minute count time the thin layer density gauge will display “Dens: X.X PCF %MA: X.XX% 100 - %MA: XX.XX% %VOID: X.XX”. Write the density down on NDOT form 040-017, rotate the thin layer density gauge 90 degrees about the center of the thin layer density gauge and take another one minute density test at this location, refer to Figure 1 for thin layer density gauge positioning. Repeat this procedure for four (4), one minute density tests at this one test location.
- f. Record each one minute density test and hand calculate the average of the four (4) tests on NDOT form 040-017. NOTE: Do NOT use the average mode in the thin layer density gauge.
- g. The average of the four (4) density tests will constitute one test site density.
- h. Repeat the above process at each of the 5 predetermined test site locations within the test section.

PERCENT COMPACTION

1. Percent compaction of an individual test site or small test section:
 - a. % Relative Compaction =
$$\frac{\text{Average Density}}{\text{Target Density}}$$
 - b. Record the percent relative compaction to the nearest whole percent.
2. Take the average of the five (5) corrected densities (mean test section densities) and compute the Mean Percent Relative Compaction as follows:
 - a. Mean Percent Relative Compaction =
$$\frac{\text{Mean Test Section Density}}{\text{Target Density}}$$
 - b. Record the Mean Percent Relative Compaction to the nearest whole percent.
3. Refer to Standard Specifications for the minimum and maximum density requirements.

ADDITIONAL ROLLING PROCEDURES

1. If an individual test either on the mat or on a joint does not meet the required minimum specifications for compaction, additional rolling may be required. After additional rolling, take another test by testing at a single location chosen at random within the same subsection (This is not considered a re-test, since there are no re-tests on plantmix or cold-recycle. The second test will be the one documented for the complete test section). Note: Any changes from the original compaction must be documented under remarks.
2. If the mean test section compaction for the mat does not meet the required minimum specifications for compaction, additional rolling may be required on the entire test section. After additional rolling, take a series of five (5) tests using a new random block number, see Figure 2. (This is not considered a re-test, since there are no re-tests on plantmix or cold-recycle. If the section continues to fail a new control strip may have to be established). Note: Any changes from the original compaction must be documented under remarks.
3. If the compactive effort still gives a failing test, joint test or test section, the Resident Engineer must indicate under the remarks on NDOT form 040-017 what necessary steps are to be taken if any pertaining to the failure in question.

**TABLE OF
 RANDOM NUMBERS**

A	B	A	B	A	B	A	B	A	B					
1	.576	.730	2	.430	.754	3	.271	.870	4	.732	.721	5	.998	.239
	.892	.948		.858	.025		.935	.114		.153	.508		.749	.291
	.669	.726		.501	.402		.231	.305		.009	.420		.517	.858
	.609	.482		.809	.140		.396	.025		.937	.310		.253	.761
	.971	.824		.902	.470		.997	.392		.892	.957		.640	.463
6	.053	.899	7	.554	.627	8	.427	.760	9	.470	.040	10	.904	.993
	.810	.159		.225	.163		.549	.405		.285	.542		.231	.919
	.081	.277		.035	.039		.860	.507		.081	.538		.986	.501
	.982	.468		.334	.921		.690	.806		.879	.414		.106	.031
	.095	.801		.576	.417		.251	.884		.522	.235		.398	.222
11	.509	.025	12	.794	.850	13	.917	.887	14	.751	.608	15	.698	.683
	.371	.059		.164	.838		.289	.169		.569	.977		.796	.996
	.165	.996		.356	.375		.654	.939		.815	.592		.348	.743
	.477	.535		.337	.155		.767	.187		.579	.787		.358	.595
	.788	.101		.434	.638		.021	.894		.324	.871		.698	.539
16	.566	.815	17	.622	.548	18	.947	.169	19	.317	.472	20	.864	.466
	.901	.342		.873	.964		.942	.985		.123	.086		.335	.212
	.470	.682		.412	.064		.150	.962		.925	.355		.909	.019
	.068	.242		.667	.356		.195	.313		.396	.460		.740	.247
	.874	.420		.127	.284		.448	.215		.833	.652		.601	.326
21	.897	.877	22	.209	.862	23	.428	.117	24	.100	.259	25	.425	.284
	.875	.969		.109	.843		.759	.239		.890	.317		.428	.802
	.190	.696		.757	.283		.666	.491		.523	.665		.919	.146
	.341	.688		.587	.908		.865	.333		.928	.404		.892	.696
	.846	.355		.831	.218		.945	.364		.673	.305		.195	.887
26	.882	.227	27	.552	.077	28	.454	.731	29	.716	.265	30	.058	.075
	.464	.658		.629	.269		.069	.998		.917	.217		.220	.659
	.123	.791		.503	.447		.659	.463		.994	.307		.631	.422
	.116	.120		.721	.137		.263	.176		.798	.879		.432	.391
	.836	.206		.914	.574		.870	.390		.104	.755		.082	.939
31	.636	.195	32	.614	.486	33	.629	.663	34	.619	.007	35	.296	.456
	.630	.673		.665	.666		.399	.592		.441	.649		.270	.612
	.804	.112		.331	.606		.551	.928		.830	.841		.602	.183
	.360	.193		.181	.399		.564	.772		.890	.062		.919	.875
	.183	.651		.157	.150		.800	.875		.205	.446		.648	.685

FIGURE 1

State of Nevada
Department of Transportation
Materials Division

METHOD OF TEST FOR EMULSIFIED ASPHALT

Follow AASHTO T 59 in its entirety with the following exceptions:

SAMPLE CONDITIONING FOR TESTING

Replace this section with the following:

All emulsions with viscosity requirements of 50°C (122°F) should be heated to $50 \pm 3^\circ\text{C}$ ($122 \pm 5^\circ\text{F}$) in the original sample container in an oven or water bath set at a temperature not exceeding $71 \pm 3^\circ\text{C}$ ($160 \pm 5^\circ\text{F}$). The sample containers should be tightly sealed, especially if testing solvent-based emulsions. Open the containers slowly to relieve pressure. After the sample reaches $50 \pm 3^\circ\text{C}$ ($122 \pm 5^\circ\text{F}$), stir the sample to achieve homogeneity. Samples of solvent-based emulsions, such as CMS-2, CMS-2h and CMS-2s, should not be maintained at a temperature of $50 \pm 3^\circ$ ($122 \pm 5^\circ\text{F}$) for more than three hours.

RESIDUE AND OIL DISTILLATE BY DISTILLATION - PROCEDURE

Add to this section the following:

Polymer modified emulsions will not be sieved prior to pouring into the test molds and containers.

It may not be possible to determine the volume of the oil distillate to the nearest 1/2 mL due to the lack of a clear line of demarcation between the water, emulsifier and the oil distillate. In this case, seal the graduated cylinder and place it in a freezer at a temperature of $-18 \pm 3^\circ\text{C}$ ($0 \pm 5^\circ\text{F}$) until separation between water and oil is established, but no more than three hours. Afterwards, allow the sample to thaw completely in the graduated cylinder and then record the oil distillate volume.

EMULSIFIED ASPHALT RESIDUE BY EVAPORATION - APPARATUS

Replace the beakers and the glass rods in this section with the following:

Containers, 355 mL (12 oz) covered cylindrical seamless metal containers, with an approximate diameter of 86 mm (3 3/8 in.) and depth of 57 mm (2 1/4 in.).

Glass Rods, with flame-polished ends, having an approximate diameter of 6.4 mm (1/4 in.) and length of 152.4 (6 in.) for use with the 355 mL (12 oz) metal containers.

RESIDUE BY EVAPORATION - PROCEDURE

Replace this section with the following:

Determine the mass of each container with a glass rod and cover to the nearest 0.1 g. Pour 50 ± 0.1 g of thoroughly mixed, emulsified asphalt into each of three containers. Place the containers containing the rods and sample in the oven, the temperature of which has been adjusted to $163 \pm 2.8^\circ\text{C}$ ($325 \pm 5^\circ\text{F}$), for two hours. The containers shall be loosely covered to avoid loss of material. At the end of this period remove each container and stir the residue thoroughly. Replace the containers in the oven for one hour and then remove the containers from the oven. Allow the containers to cool to room temperature. Determine the mass of each container, with the rods and covers.

When tests on the residue from the emulsion are required, replace the containers in the oven until the asphalt residue is sufficiently fluid to pour. Pour the residue into suitable containers and molds for making such tests as desired. If there is foreign matter in the residue, the material shall be poured through a No. 50 ($300 \mu\text{m}$) sieve prior to pouring into the test molds and containers. Polymer modified emulsions will not be sieved.

Note: Care must be taken to prevent loss of asphalt from the container through foaming or spattering or both.

Note: As the method for residue by evaporation tends to give an asphaltic residue lower in penetration and ductility than the distillation method, material may be accepted but shall not be rejected as failing to meet specifications on data obtained by evaporation. If residue from evaporation fails to meet the requirements for properties specified for residue from distillation, tests shall be rerun using the distillation method.

RESIDUE BY EVAPORATION - CALCULATION AND REPORT

Replace this section with the following:

Calculate the percentage of residue on each container as follows:

$$\text{Residue, percent} = 2(M_{\text{brt}} - M_{\text{br}})$$

where:

M_{brt} = mass of container, rod, cover and residue, g, and

M_{br} = tare mass of container, rod, and cover, g.

Report the percentage of residue by evaporation as the average of the three results.

PARTICLE CHARGE OF CATIONIC EMULSIFIED ASPHALTS - PROCEDURE

Replace the section specifying sample conditioning procedure with the following:

Heat the emulsion to be tested to $50 \pm 3^{\circ}\text{C}$ ($122 \pm 5^{\circ}\text{F}$) in an oven or water bath set at a temperature not exceeding $71 \pm 3^{\circ}\text{C}$ ($160 \pm 5^{\circ}\text{F}$). Stir the emulsion thoroughly to ensure uniformity of temperature.

VISCOSITY (SAYBOLT FUROL) - APPARATUS

Replace the specification for sieve with the following:

Sieve, 850 μm (No. 20) sieve of wire cloth, with a diameter of $1\ 1/2 \pm 1/8$ in., framed to fit into the top of the viscometer tube.

Add the following to the specification for thermometers:

An equivalent thermometric device that has been calibrated in accordance with ASTM E 220 may be used. ASTM mercury thermometers shall be used for referee testing.

Replace the specification for water bath with the following:

Oven or Water Bath capable of maintaining temperatures to $71 \pm 3^{\circ}\text{C}$ ($160 \pm 5^{\circ}\text{F}$).

VISCOSITY (SAYBOLT FUROL) - PROCEDURE

Replace the procedure for testing at 50°C (122°F) with the following:

Test at 50°C (122°F) - Clean and dry the viscometer and insert the cork. Heat the emulsion sample to a temperature of 51.4°C to 60°C (124.5°F to 140°F) in an oven or water bath set at a temperature not exceeding $71 \pm 3^{\circ}\text{C}$ ($160 \pm 5^{\circ}\text{F}$). The temperature is dependent on the material being tested and will be selected to achieve a temperature of approximately 50°C (122°F) after the emulsion has been poured into the viscometer. Stir the sample thoroughly without incorporating bubbles. Immediately pour the emulsion through the No. 20 sieve into the viscometer until it is above the overflow rim. Stir the emulsion in the viscometer at 60 rpm with the thermometer until the test temperature is attained, avoiding bubble formation. Adjust the bath temperature until the emulsion temperature remains constant for 1 minute at $50 \pm 0.05^{\circ}\text{C}$ ($122 \pm 0.1^{\circ}\text{F}$). Withdraw the thermometer. Quickly remove the excess emulsion from the gallery with a suction pipet. Determine the viscosity as prescribed in AASHTO T 72. Report the results to the nearest full second.

During field testing, the material may be received at a temperature exceeding 60°C (140°F). In this case, the sample may be cooled by pouring approximately 100 mL into a 400 mL beaker, or other suitable container. Stir the emulsion with a wide circular motion at approximately 60 rpm with a thermometer

until a temperature of 51.4°C to 60°C (124.5°F to 140°F) is obtained.

If sufficient material to fill the viscometer tube will not pass through a single sieve due to excess particulates, the viscosity will be considered unobtainable by this procedure.

Note: The Saybolt Furol viscometer is satisfactory for testing emulsified asphalt when the viscosity is not less than 20 seconds.

DEMULSIBILITY- PROCEDURE AND CALCULATION

Change this section to use the percentage of residue by either distillation or evaporation as per Test Method Nev. T759 or Nev. T756.

SIEVE TEST - PROCEDURE

Change the mass of emulsified asphalt required for testing from 1000 g to 500 g.

SIEVE TEST - CALCULATION

Replace this section with the following:

Calculate the percentage of sample retained on the sieve as follows:

$$\text{Sample retained, percent} = (M_{\text{spr}} - M_{\text{sp}}) / 5$$

where:

M_{sp} = mass of sieve and pan, g, and

M_{spr} = mass of sieve, pan, and residue, g.

State of Nevada
Department of Transportation
Materials Division

**METHOD OF TEST FOR DETERMINING BITUMEN RATIO IN HOT MIX ASPHALT
BY THE IGNITION METHOD**

SCOPE

This test method covers the determination of bitumen ratio on hot mix asphalt (HMA) paving mixtures and pavement samples by ignition of the asphalt cement in an ignition furnace at 482°C or 538°C (900°F or 1000°F).

APPARATUS

1. Furnace (Figure 1), forced air ignition furnace capable of maintaining temperatures to $538 \pm 5.5^{\circ}\text{C}$ ($1000 \pm 10^{\circ}\text{F}$), with an internal balance thermally isolated from the furnace chamber accurate to 0.1 g. The balance shall be capable of weighing a 3,000 g sample in addition to the sample baskets. A data collection system will be included so that the weight can be automatically determined and displayed during the test. The furnace shall have a built-in computer program to calculate the change in mass of the sample baskets and provide for the input of a calibration factor to account for aggregate loss or incomplete asphalt combustion. The furnace shall provide a printed ticket with the initial sample mass, sample mass loss, temperature compensation, calibration factor, corrected asphalt content (%), corrected bitumen ratio (%), test time and test temperature. The furnace chamber dimensions shall be adequate to accommodate a sample size of 3,000 g. The furnace shall provide an audible alarm and visible indicator when the sample mass loss does not exceed 0.01 percent of the total sample mass for three consecutive minutes. The furnace door shall be equipped so that the door cannot be opened during the ignition test. A method for reducing furnace emissions shall be provided. If the furnace uses filters, they must be self-cleaning ceramic filters. The furnace shall be vented into a hood or to the outside and shall have no noticeable odors escaping into the laboratory. The furnace shall have a fan with the capability to pull air through the furnace to expedite the test and to reduce the escape of smoke into the laboratory.
2. Balance, with a capacity of 12,000 g and sensitive to 0.1 g.
3. Sample baskets (Figure 2), two or more nested sample baskets will be used that allow the samples to be thinly spread and allow air to flow up through and around the sample particles. The sample shall be completely enclosed with screen mesh or perforated steel plate with maximum and minimum openings of No. 6 (3.35 mm) and No. 30 (600 μm).
4. Catch pan (Figure 2), sufficient size to hold the sample baskets so that aggregate particles falling through the screen mesh are caught. Wire guards will be provided to attach the sample baskets firmly to the catch pan.
5. Retriever (Figure 2), capable of safely moving the sample baskets in and out of the heated furnace.

6. Oven, capable of maintaining a temperature of $110^{\circ} \pm 5^{\circ}\text{C}$ ($230^{\circ} \pm 9^{\circ}\text{F}$).
7. Safety equipment (Figure 2), face shield or safety glasses to provide eye protection when loading and unloading sample baskets out of the furnace. Gloves capable of withstanding temperatures up to 538°C (1000°F). A protective cage to surround the sample baskets during cooling.
8. Miscellaneous equipment, pans for holding samples. Spatulas and brushes for removing asphalt mixtures and aggregate from baskets and pans.

FURNACE CLEANING

1. The furnace shall be cleaned before a calibration factor (C.F) is obtained and weekly thereafter, by the field lab tester, to ensure proper operation. Follow the instructions below for proper cleaning. Cleaning shall be performed with the furnace at room temperature.
 - a. After the power to the furnace has been disconnected, disassemble the top vent tube from the blower motor. Using a Shop-Vac, clean out the vent tube and the blower motor of all soot build up.
 - b. Remove the top two covers of the furnace, using a Shop-Vac clean the area under the top two covers. Oil the blower motor with Anderol 465 lubricant.
 - c. Open the chamber door. Using a Shop-Vac clean the area around chamber door. Inspect the door insulation for black streaks of soot. (Usually running from the outside corners of the insulation towards the center.) If black streaks are present, it is a sign the door is loose and the chamber is sucking in air. Contact the local IA lab for repair.
 - d. Remove the hearth plate and Shop-Vac furnace walls. While the hearth plate is removed, verify ceramic support tube placement. The four ceramic support tubes located in the bottom of the furnace chamber, shall be positioned and seated on the appropriate pins on the balance plate, the tubes shall be centered and shall not touch the sides of the ports. Once the position of ceramic support tubes has been verified place the hearth plate on top of the tubes.
 - e. In the 1087 and 1275 series furnace there is an orifice in the back of the chamber. This orifice is the opening that extends upward into the top plenum. It acts like a chimney to prevent smoke buildup in the chamber. Ensure this orifice is free of any soot buildup. A pipe cleaner or stiff wire brush can be used to clean out the orifice.
 - f. When all cleaning is complete, oil the blower motor with Anderol 465 lubricant. Put the furnace back together and place heat tape back around the vent tube and blower connection.
 - g. Perform the lift test on the furnace after the weekly cleaning has been completed. Record the lift test on the weekly calibration check on NDOT form 040-053. Refer to the Operation Manual for the lift test procedure and lift ranges.

CALIBRATION

1. A calibration factor (C.F.) is required to account for the loss of aggregate during the ignition process or for the incomplete combustion of the asphalt in a sample. The C.F. may be affected by the type, source and gradation of aggregate used, by the type, quantity, and brand of asphalt used, and by the addition of mineral filler. Therefore, to optimize accuracy, a C.F. shall be established for every aggregate type and source and for every type and brand of asphalt used. Any change in the aforementioned will require that a new C.F. be established.

In addition to the reasons listed above, a new C.F. will be required under the following conditions:

- a. Change in the recommended bitumen ratio of $\pm 0.4\%$ or greater.
- b. Change in any one of the aggregate bin percentages of $\pm 4.0\%$ or greater
- c. Change in the amount of mineral filler or a change in the method of adding mineral filler.
- d. If the Resident Engineer has a reason to suspect a material change that may affect the C.F..

The C.F. is also dependent upon the testing temperature. Testing will be performed at either 538°C or 482°C (1000°F or 900°F). A test temperature is selected that will provide adequate ignition of the asphalt, while minimizing aggregate loss.

2. After the hotplant has been calibrated, obtain the combined and marinated aggregate (coldfeed samples) at the hotplant per Test Method Nev. T200. Prepare four coldfeed samples for the C.F. per Test Method Nev. T203. All C.F. calculations shall be completed on NDOT form 040–053 or 040–053A.
3. Using the most current job mix formula (JMF), calculate the amount of mineral filler based on actual bin percentages, per section 401 of the Standard Specifications for Road and Bridge Construction.

Example:

7%	– 1 in. aggregate	(coarse)
21%	– 3/4 in. aggregate	(coarse)
25%	– 1/2 in. aggregate	(coarse)
20%	– crushed fines	(fine)
27%	– washed sand	(fine)

53%	coarse aggregate	x 0.01	=	0.53%	mineral filler
47%	fine aggregate	x 0.02	=	0.94%	mineral filler

(Example: 2500 g of blended aggregate including 1.47% mineral filler)

$$\text{Formula: } \frac{\text{Dry Aggregate} + \text{Mineral Filler}}{1 + [(\% \text{ Mineral Filler}) \div 100]} = \text{Dry Aggregate without Mineral Filler}$$
$$\frac{2500\text{g aggregate}}{1.0147 \text{ mineral filler}} = 2463.8 \text{ g of aggregate without Mineral Filler}$$

4. Preheat the ignition furnace to 538°C (1000°F).
5. Dry the coldfeed sample to a constant mass, per Test Method Nev. T112. Heat up the asphalt in the oven so that it is in a liquid state (easy to stir and pour).
6. Place the coldfeed sample into a heated (230° ± 9°F), tared and buttered bowl and record the weight. Place the buttered bowl with material into the oven and calculate how much asphalt and/or RAP will need to be added. Refer to the Standard Operation Procedures Manual sections, 040–053 or 040–053A.
7. Once asphalt and/or RAP calculations are completed remove the buttered bowl with the material from the oven with gloves and form a “crater” in the middle of the material. Place the buttered bowl with material on the tared balance. Use a buffer to protect the balance from the heat.
8. Once the “crater” is made in the center of the material and the balance has been tared, stir the preheated asphalt with a stir rod to ensure uniformity before pouring. Carefully pour the calculated amount of hot asphalt into the “crater”. Stop when the balance reads the exact amount of asphalt calculated for the calibration, if the required amount of asphalt is exceeded, it is permissible to carefully dab out the extra asphalt with a paper towel. When calibrating for a RAP material, add the calculated amount of RAP material to the buttered bowl, material and asphalt.
9. Place the buttered bowl containing the material, asphalt and rap (if required) on a burner to keep warm while stirring into a homogenous mixture.
10. Once two calibration samples are mixed, test the samples in accordance with the “PROCEDURE” section, steps 4 through 10, using a correction factor of zero.
 - a. After placing material in the basket and recording the weight. The final weight shall be within 10 grams of the “Total Weight” as calculated on NDOT form 040–053 or 040–053A.
11. If the difference between the “Bit. Ratio” of the two samples is less than 0.15%, these results may be used to calculate the C.F.. If the difference between the “Bit. Ratio” for the two samples exceeds 0.15, repeat the calibration procedure with the two additional samples, repeating steps 5 through 10 of the “CALIBRATION” section. From the four samples discard the high and the low results and determine the C.F. from the remaining two results. The difference between these two remaining results must be within 0.15%.
12. Calculate the difference between the “Bit. Ratio” and “Bit. Ratio Total” to obtain the C.F. for each sample. To obtain the C.F. for this material take the average of the two correction factors to the nearest 0.01.

It is possible that some asphalt/aggregate combinations will produce a “Bit. Ratio” less than the mix design bitumen ratio. This will produce a negative C.F., rather than correcting for aggregate loss, a negative C.F. corrects for the asphalt that is not completely ignited during the test procedure.

13. If the C.F. exceeds 1.00%, lower the test temperature to 482°C (900°F) and repeat the calibration procedure. Use the C.F. obtained at 482°C (900°F) even if it exceeds 1.00%. If excessive aggregate breakage occurs at 538°C (1000°F), the test temperature shall be lowered to 482°C (900°F) and the calibration procedure repeated even if the C.F. does not exceed 1.00%.
14. The C.F. is to be recorded and used to determine the corrected bitumen ratio of HMA paving mixtures as per the “PROCEDURE” section. The temperature for testing HMA samples in the “PROCEDURE” section shall be the same temperature selected for testing calibration samples. The C.F. will be verified by testing a single sample at least once a week by the procedure outlined in this section. If the difference between the “Bit. Ratio” and “Bit. Ratio Total” differs from the C.F. by more than 0.20, a new C.F. will be established as per this section. Record the C.F. including weekly checks on NDOT form 040–053 or NDOT form 040–053A if utilizing RAP.
15. The C.F. to be used for HMA paving mixtures shall be the average between the two C.F. samples tested at the same temperature to the nearest 0.01.

SAMPLE PREPARATION

1. Obtain a representative sample of the paving mixture per Test Method Nev. T200.
2. If the mixture is not sufficiently soft to separate during splitting, place it in an oven at 135°C (275°F) until it can be easily handled.

Obtain a representative split of the heated sample per Test Method Nev. T203. The size of the test sample shall conform to the minimum mass requirements per Test Method Nev. T206 after the ignition process.

If the sample size exceeds the capacity of the furnace, the sample may be split into two representative portions and the results combined after testing. Sample sizes shall not be more than 500 g greater than the minimum recommended sample mass.

3. Oven dry the sample or use a representative split of the material and obtain the moisture content (MC) per Test Method Nev. T306.

PROCEDURE

1. Preheat the ignition furnace to the proper temperature for the sample to be tested as determined in the “CALIBRATION” section.
2. Weigh the mass of the sample basket assembly (sample baskets, catch pan and guards) and write on NDOT form 040–050.

3. Divide the representative split of material into two approximately equal portions, evenly distribute each sample portion into the sample baskets and spread into thin layers. If the sample basket size allows, keep the mix approximately 25 mm (1 in.) away from the sides of the sample baskets to reduce aggregate loss. Weigh the sample, sample baskets, catch pan, and guards. Calculate the dry mass (MI) of the sample (total sample mass – mass of the sample basket assembly) to the nearest 0.1 g, and record on NDOT form 040–050.
4. Enter the dry mass (MI) of the sample and the C.F., obtained in the “CALIBRATION” section, into the furnace.

To enter the C.F. into the furnace, on the front control panel of the furnace, press the button on the keypad labeled “calibration factor”, immediately enter the C.F. using the number keypad and press enter, wait a moment and press the “calibration factor” button again to ensure the C.F. number entered is correct.

To enter the dry mass (MI) of the sample into the furnace, on the front control panel of the furnace and press the button on the keypad labeled “weight”, immediately enter the dry mass (MI) using the number keypad and press enter, wait a moment and press the “weight” button again to ensure that the dry mass (MI) weight entered is correct.

Take care to input the correct sign (positive or negative) when entering the C.F., press the “calibration factor” button twice to enter a negative value. Press the “calibration factor” button twice to return to a positive value.

5. Before placing the sample in the furnace, zero out the balance by pressing the “(0)” button located on the keypad of the furnace.
6. Open the furnace door and gently set the sample basket assembly on the hearth plate. Do not slide the sample basket assembly on the hearth plate or against the thermocouple. Ensure that the sample basket does not contact any of the interior walls of the furnace. Verify that the total sample mass (including the sample basket assembly) displayed on the furnace balance equals the total mass recorded within ± 5 g. Differences greater than 5 g or failure of the furnace balance to stabilize may indicate that the sample basket assembly is contacting a furnace wall. Initiate the test, by pressing the “start” button on the furnace keypad. This will lock the furnace door and start the combustion blower.

The furnace temperature will drop below the set point (538° or 482°C) when the door is opened, but will recover with the door is closed and when ignition occurs.

7. Burn the sample in the furnace at the specified temperature until the mass loss does not exceed 0.01 percent of the dry mass for three consecutive one minute intervals. The visible indicator and audible stable alarm will indicate that the test is complete. At this point press the “stop” button on the furnace, the test will stop and print out the results.

If there is a power failure and the furnace turns off during ignition, turn the furnace back on and make sure the sample completed combustion. DO NOT open the door until combustion is complete. If a manual calculation of the bitumen ratio is needed, make a note on NDOT form 040–050 as to why a

manual calculation was performed.

8. Remove the sample basket assembly from the furnace and allow it to cool. The sample basket assembly shall be placed on a heat resistant surface and covered with the protective cage during cooling.
9. B.R. (printed tape) will be automatically computed by the furnace and reported on a printed tape. If the M.C. has been determined, subtract the M.C. from the B.R. (printed tape) and report as the B.R..
12. If for any reason the furnace cannot be used to automatically calculate a corrected B.R., calculations can be performed manually. Weigh the total mass of the cooled sample after ignition (sample, sample baskets, catch pan, and guards). Calculate the B.R. by the following formula:

$$\text{B.R. from Manual Calculation} = \left[\left(\frac{\text{MI} - \text{MF}}{\text{MF}} \right) \times 100 \right] - \text{CF}$$

Where:

MI = Dry mass of HMA sample prior to ignition.

MF = Mass after ignition.

CF = Calibration Factor obtained in accordance with the "CALIBRATION" section.

Determine the mass of the aggregate after ignition within 30 minutes of cooling.

13. The aggregate remaining after ignition should be used for the sieve analysis if required per the specifications, per Test Method Nev. T206.

REPORT

1. B.R. shall be reported to the nearest 0.01% on NDOT form 040-050 and to the nearest 0.1% on NDOT form 040-011.



Figure 1
Furnace

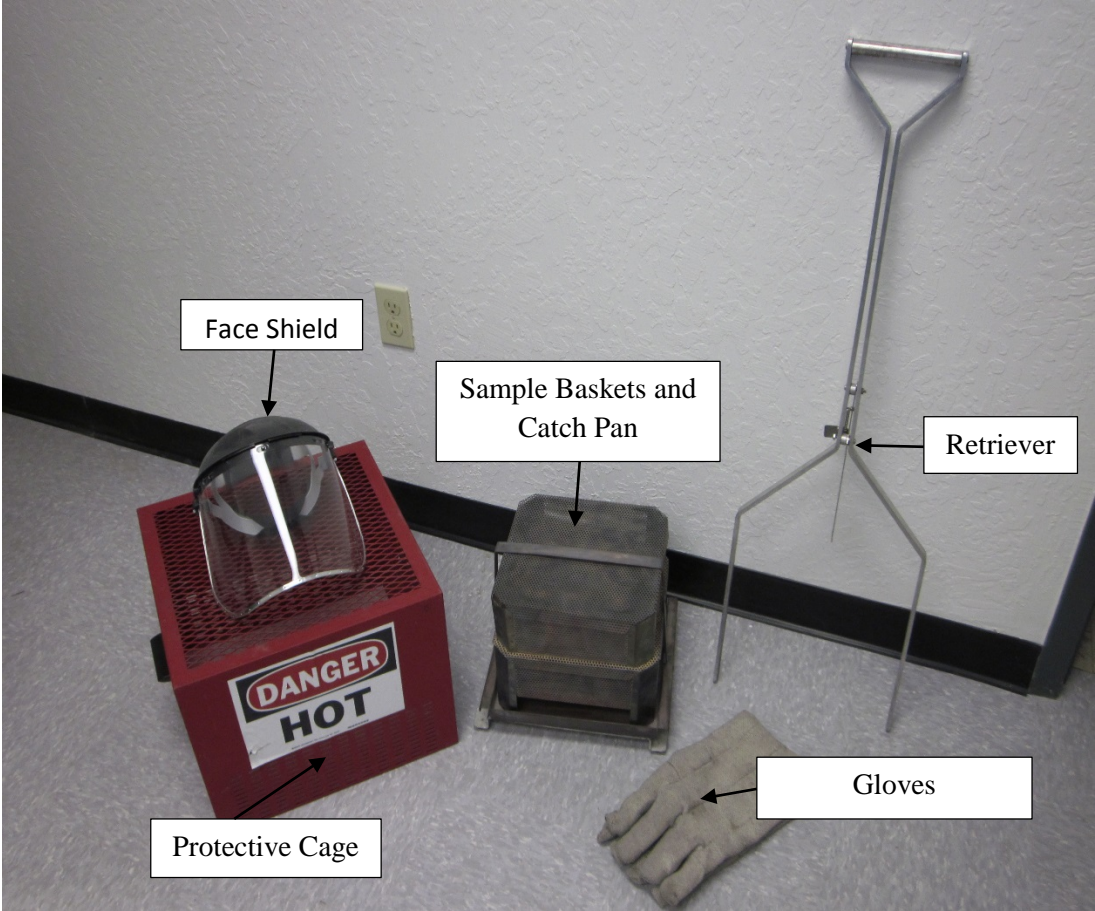

Figure 2



Standard Test Method for Indicating Moisture in Concrete by the Plastic Sheet Method¹

This standard is issued under the fixed designation D4263; the number immediately following the designation indicates the year of original adoption or, in the case of revision, the year of last revision. A number in parentheses indicates the year of last reapproval. A superscript epsilon (ϵ) indicates an editorial change since the last revision or reapproval.

This standard has been approved for use by agencies of the Department of Defense.

1. Scope

1.1 This test method is used to indicate the presence of capillary moisture in concrete.

1.2 The values stated in inch-pound units are to be regarded as standard. The values given in parentheses are mathematical conversions to SI units that are provided for information only and are not considered standard.

1.3 *This standard does not purport to address all of the safety concerns, if any, associated with its use. It is the responsibility of the user of this standard to establish appropriate safety and health practices and determine the applicability of regulatory limitations prior to use.* For specific caution statements, see Section 4.

2. Significance and Use

2.1 Capillary moisture in the concrete may be detrimental to the performance of certain coating systems that cannot tolerate moisture on or within the surface boundary.

2.2 This test method is used prior to the application of coatings on concrete.

3. Materials

3.1 *Transparent Polyethylene Sheet*, commercially available, approximately 4 mils (0.1 mm) thick.

3.2 *Adhesive Tape* that will adhere to the substrate. (Duct tape 2 in. (50 mm) wide is suggested.)

¹ This test method is under the jurisdiction of ASTM Committee D33 on Protective Coating and Lining Work for Power Generation Facilities and is the direct responsibility of Subcommittee D33.05 on Application and Surface Preparation.

Current edition approved May 1, 2012. Published May 2012. Originally approved in 1983. Last previous edition approved in 2005 as D4263 – 83 (2005). DOI: 10.1520/D4263-83R12.

4. Cautions

4.1 This test method shall be conducted when the surface temperature and ambient conditions are within the established parameters for application of the coating system.

4.2 Avoid direct sunlight, direct heat, or damage to the plastic sheet, as such treatment affects the reliability of the results.

5. Procedure

5.1 Tape a segment of plastic sheet, approximately 18 by 18 in. (457 by 457 mm), tightly to the concrete surface making sure that all edges are sealed.

5.2 Allow the plastic sheet to remain in place a minimum of 16 h.

5.3 After the allowed time has elapsed, remove the plastic sheet and visually inspect the underside of the sheet and the concrete surface of the patch for the presence of moisture.

5.4 Sampling:

5.4.1 *Floors*—One test area per 500 ft² (46 m²) or portion thereof, of surface areas unless otherwise specified.

5.4.2 *Walls and Ceilings*—One test area per 500 ft² (46 m²) or portion thereof, of surface area unless otherwise specified.

5.4.3 The recommended practice is a minimum of one test for each 10 ft (3 m) of vertical rise in all elevation starting within 12 in. (300 mm) of the floor.

6. Report

6.1 Report the presence or absence of moisture.

7. Precision and Bias

7.1 This test method indicates the presence of capillary moisture. This method is purely qualitative. No precision or bias has been established for this test method.

8. Keywords

8.1 concrete; moisture

ASTM International takes no position respecting the validity of any patent rights asserted in connection with any item mentioned in this standard. Users of this standard are expressly advised that determination of the validity of any such patent rights, and the risk of infringement of such rights, are entirely their own responsibility.

This standard is subject to revision at any time by the responsible technical committee and must be reviewed every five years and if not revised, either reapproved or withdrawn. Your comments are invited either for revision of this standard or for additional standards and should be addressed to ASTM International Headquarters. Your comments will receive careful consideration at a meeting of the responsible technical committee, which you may attend. If you feel that your comments have not received a fair hearing you should make your views known to the ASTM Committee on Standards, at the address shown below.

This standard is copyrighted by ASTM International, 100 Barr Harbor Drive, PO Box C700, West Conshohocken, PA 19428-2959, United States. Individual reprints (single or multiple copies) of this standard may be obtained by contacting ASTM at the above address or at 610-832-9585 (phone), 610-832-9555 (fax), or service@astm.org (e-mail); or through the ASTM website (www.astm.org). Permission rights to photocopy the standard may also be secured from the ASTM website (www.astm.org/COPYRIGHT/).

of hazardous substances including epoxy compounds.

ANSI standards: ANSI Z 129.1 and ANSI K 68.1 provide further guidance regarding classification and precautions.

9.1.6—Many epoxy resin formulations are classified as "corrosive" or "flammable" in 49 CFR Transportation Subchapter C "Hazardous Materials Regulations." Packaging, labeling, and shipping for such materials is controlled by 49 CFR Transportation.

9.2—Safe handling

Safe handling of epoxy materials can be accomplished by:

9.2.1—Working in a well-ventilated area. As with most chemicals, materials should be stored below eye level.

9.2.2—Disposable suits and gloves, available from many suppliers of work garments, are suitable for this use. Gloves should be tested for resistance to resins and solvents. Disposable rubber or plastic gloves are recommended and should be discarded after each use. Gloves should be tested for resistance to resins and solvents. Cotton gloves, if used, should never be reused if they have become soiled with epoxy compounds.

9.2.3—Careful attention to personal cleanliness and protection. Safety eye-glasses or goggles are strongly recommended both when handling epoxy compounds and acids. Involuntary habits such as face scratching or eyeglass adjustment should be avoided. For similar reasons, handling important tools, eating or smoking should not be done until the individual has washed up. When wearing soiled gloves, the workers should avoid touching door handles and other equipment which may subsequently be touched by a person not wearing gloves.

9.2.4 *Federal regulations* — CFR 29, Part 1910 (OSHA Standards) regulate handling of hazardous substances including epoxy compounds.

9.3—What to do in case of direct contact

9.3.1 *To the clothing* — Remove soiled clothing at once and change to clean garments. If the soiled garment cannot be thoroughly cleaned, it should be destroyed.

9.3.2 *To the body* — Shower immediately with soap and water to remove spilled epoxy compounds from the body. Avoid contact with the genital areas until after the hands are carefully cleaned of all epoxy.

9.3.3 *To the eyes* — Flush out with large amounts of water for at least 15 min, followed by immediate medical attention. (Safety goggles will usually prevent getting chemicals into eyes.)

9.3.4 *Other places* — Do not use solvents other than soap and water or water soluble proprietary cleaners. Most solvents merely dilute the epoxy compounds, aiding them in penetrating the skin. At the same time, solvents tend to dry out the skin and any subsequent exposure is more likely to cause problems.

9.4—Use of solvents

9.4.1 *General* — The epoxy compounds considered for

concrete applications are usually solvent free. However, solvents may be used as a convenience for cleanup of equipment and areas on which epoxies might be spilled. The solvents used will require additional precautions depending on the characteristics of the type used. It is generally true that solvents should not be used to remove epoxy products from the skin. They tend to dry the skin and may themselves cause dermatitis. Additionally, they dissolve the epoxy compound and carry it into more intimate contact with the skin, thus aggravating the dermatitic problems which already exist due to skin contact with the epoxy compound. The following hazards might be encountered in the use of solvents and should be taken into consideration. It may be emphasized that when using a solvent, the combined hazards of both the solvent and the epoxy compound are encountered.

9.4.1.1 *Flammability and explosion hazard* — Many solvents having low flash points are not recommended and should be avoided. Cleaning solvents such as ketones are red label materials and present a fire hazard. If used, adequate ventilation should be provided, equipment should be grounded and smoking or other fire initiating devices should be barred from the area of use. The chlorinated solvents, while not representing a fire hazard, will present a toxicological problem if a person smokes in their presence or if a fire occurs in the immediate area.

9.4.1.2 *Vapor hazard* — Most solvents have some degree of volatility and the vapors can be toxic when inhaled. Avoid using solvents which may be harmful.

9.4.1.3 *Contact hazard* — Some cleanup solutions contain phenols or other very aggressive chemicals which can cause burns or other serious effects when contacting any part of the body directly or indirectly. Use such materials with great care following the recommendations of the supplier.

9.4.1.4 Dispose of spent solvents in accordance with local and federal regulations.

9.5—Education of personnel

No amount of equipment will substitute for worker education. Those involved in using epoxy materials should be thoroughly informed of the characteristics and hazards of the particular materials they must handle. Not only label instructions but also the manufacturer's literature and MSDS sheets should be reviewed and pertinent information passed on to each worker. The handling of epoxy materials is not a dangerous occupation as long as reasonable care is taken and personnel and equipment are kept clean. Instances of sensitization are rare but the possibility of a burn, a damaged eye, or other loss-of-time accidents makes knowledge and observance of safe handling practices absolutely essential. A sensitized person must not be allowed to continue working with epoxy materials.

APPENDIX A—TEST METHODS

A.1—Field test for surface soundness and adhesion

A.1.1—Clean a portion of the area to which the epoxy compound is to be applied according to prescribed cleaning methods. The area selected for testing should represent the worst of surface conditions within the area to be repaired. The test area should be large enough so that the cleaning equipment and methods of cleaning to be employed in full scale operation may be used. This avoids the possibility of attaining a degree of cleanliness in a small test area which could not be matched later with the equipment to be used on a continuing basis. The surface must be thoroughly dry before undertaking Step A.1.2.

A.1.2—Mix materials and apply a test patch according to applicable procedures of Chapters 6 and 7 using the epoxy compound to be used in the work. The test patch should cover enough of the surface to include all the typical surface conditions found in the larger areas to be covered. For example, in a warehouse subjected to considerable forklift truck traffic, the test patch should span a line to include the wheel tracks where applied load and wear are most severe, and the center areas where deposition of oil and traffic soil is heaviest.

A.1.3—After the test patch has hardened, core drill through the coating and down barely into the subsurface by means of an electric drill fitted with a carbide-tipped or diamond core bit (Fig. A.1). The core bit should be of such size as to produce a cored disc 2 in. (5 cm) in diameter which will have the appearance of a small island of coated material (Fig. A.2).

A.1.4—Bond a standard 1½ in. (3.7 cm) diameter pipe cap, the bottom surface of which has been machined smooth and shoulder-cut to provide a 2 in. (5 cm) diameter surface (Fig. A.3), to the cored disc using nearly any commercially available room temperature rapid curing epoxy compound adhesive. Mix the epoxy components according to the supplier's recommendations just

prior to use. A 2 oz (50 gm) portion of this material should have a working life of 20-25 min at 70-90 F (20-32 C). Apply a small amount of the mixed adhesive to the cored disc and to the bonding face of the pipe cap by spatula. Where desired, the bonding face may be heated to facilitate spreading of the adhesive. However, the cored disc should never be heated directly. Place the pipe cap on the cored disc. Direct a flame from a small gasoline blow-torch (an electric heat lamp or a portable gas radiant heater may be used as alternatives) into the interior of the pipe cap in such a way that no direct heat reaches the cored disc or the pavement bond line, and heat the pipe cap to about 160 F (70 C). (This temperature can readily be checked with a surface pyrometer.) Under these conditions the adhesive should harden in less than 1 minute. The bonded cap will be ready for testing as soon as it has cooled to air temperature.

A.1.5—After cooling the pipe cap and core, test the core by applying tension to it using a testing device similar to the one shown in Fig. A.4 and A.5. To prepare the testing device, screw the lower hook into the threaded pipe cap and attach to the loop on the lower portion of a Dillon dynamometer. Screw the upper hook, which has a threaded shaft, into the loading arm at the top of the rig, and attach to the loop on the upper portion of the dynamometer. When force is applied, the axis of the dynamometer must coincide with the axis of the pipe cap extended. Rotate the loading arm so that the threaded shaft and its connections are lifted, placing the pipe cap (and core) in tension. Tensile load should be applied at the approximate rate of 100 lb (45 kg) every 5 sec. The tensile load is indicated on the dynamometer gage. Record the load at which the pipe cap and connected core is separated from the concrete surface and convert to unit stress. Note the type of failure of which there are three possibilities or combinations thereof:

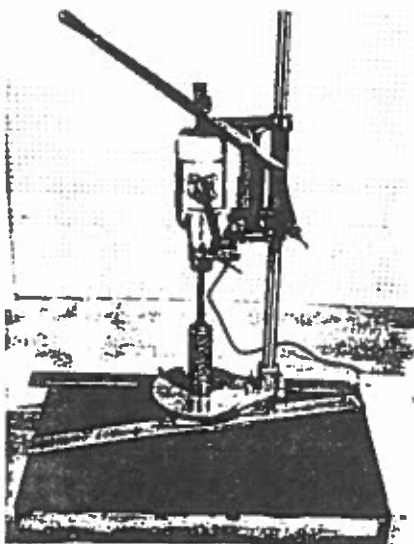

Fig. A.1—Portable carbide-tipped core drill in position for drilling

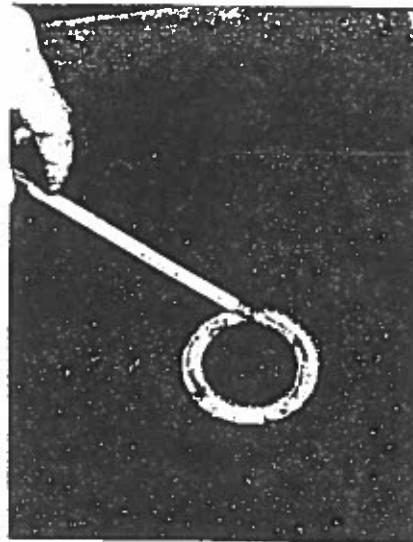

Fig. A.2—Cored disc after drilling and ready for the attachment of the pipe cap

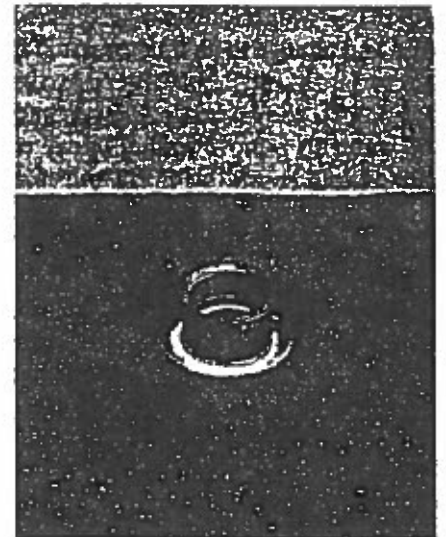

Fig. A.3—Machine faced pipe cap bonded to cored disc with epoxy compound

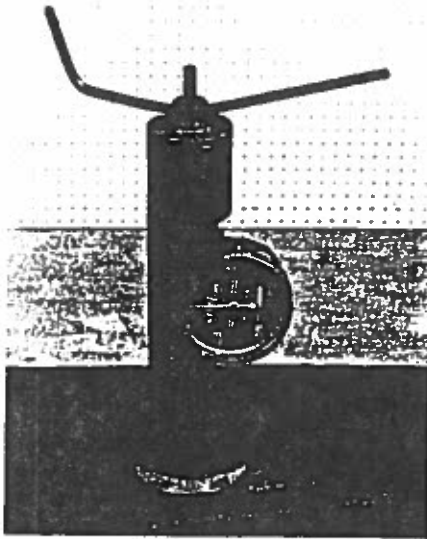

Fig. A.4—Mechanical testing device for pulling bonded pipe cap in tension

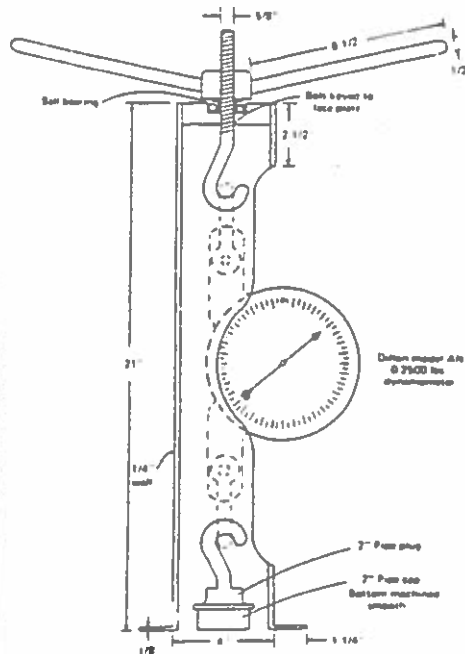

Fig. A.5—Functional sketch of mechanical testing device



Fig. A.6—Typical failure in concrete; dark spots on cap and in aggregate indicate split aggregate

- a) Failure in the concrete (cohesive concrete failure)
- b) Separation of the epoxy compound from the concrete surface (adhesive failure)
- c) Failure in the epoxy compound (cohesive resin failure)

Record the percent of each type of failure along with the load required to bring about the failure. A properly formulated epoxy compound applied to a properly prepared surface should result in a concrete failure as shown in Fig. A.6. When the pipe cap and core have been separated from the surface, the hole created by the test can easily be repaired using either an epoxy resin compound or the remaining epoxy adhesive if there is a surplus. When the strength of a concrete surface is to be tested alone, Steps A.1.1 through A.1.3 may be eliminated, except that a small area must be cleaned for bonding the pipe cap directly to the concrete surface. Tests should be performed in several areas which represent the worst conditions, and which give a statistical estimate of results to be expected.

A.2—Simplified field test for surface soundness

A.2.1—If this test is being employed to ascertain the need for surface preparation and detecting relative differences in potential surface strength over an area to be repaired, skip to Steps, A.2.2 and A.2.3. If the test is employed to ascertain adequacy of surface preparation, clean the area, or portions thereof if a large area, according to the prescribed cleaning methods. Portions of large areas to be test cleaned should be sufficient in number to be representative of the total area and each

portion should be large enough so that the cleaning equipment intended for the full scale application can be used in a standard cleaning operation. Provision should be made for conducting the test at the rate of at least one test per 100 ft² (9.3 m²) of area to be repaired. The surface to be tested must be dry before proceeding with Step A.2.2.

A.2.2—Cut 1 in. lengths of 1 in. aluminum T-section to provide a one in² bonding surface at the bottom of the flange. Drill a hole in the stem of each T-section for subsequent attachment of the testing device. Thoroughly clean the aluminum surface by abrading with crocus or emery cloth being careful to water wash and dry before using. Bond the aluminum T-section to the concrete surface using a fast setting epoxy compound mixed just prior to its use in accordance with the supplier's recommendations. This is accomplished by applying a small quantity of the epoxy compound to the concrete surface followed immediately by working the T-section into the epoxy in a manner to establish thorough contact between the epoxy, the concrete and the aluminum T-section. Upon completion of this operation, score around the perimeter of the T-section to remove excess epoxy which has squeezed out so that the bonded area will be the desired one square inch.

A.2.3—The following day, or as soon as the epoxy has set, attach a testing device similar to the one shown in Fig. A.7 to the aluminum T-section or the mechanical device described in Step A.1.5. Apply tension at an uninterrupted, uniform rate. The tensile load is indicated on the dynamometer gage. Record the load at which each T-section is separated from the concrete surface and express it as unit stress. Note the type of failure, as in Step A.1.5.

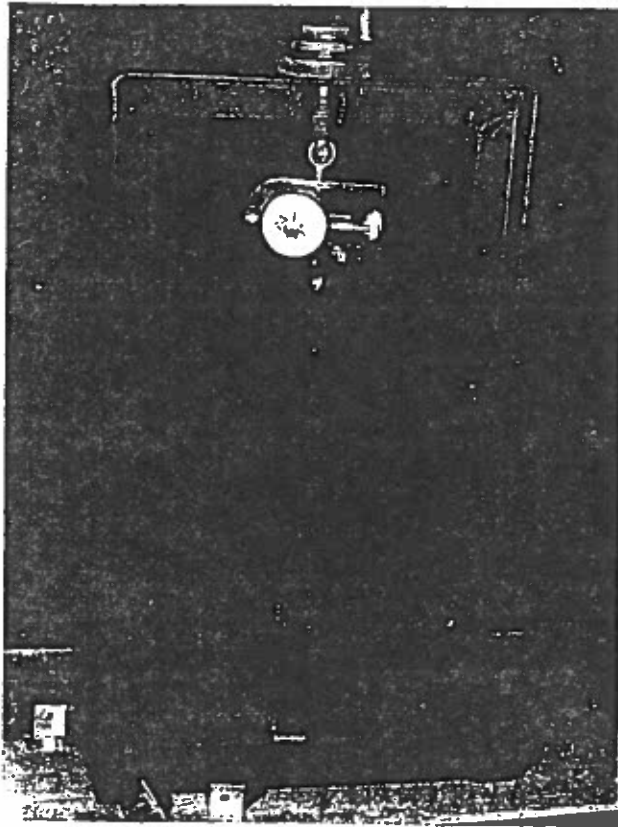

Fig. A.7—Tension frame for pulling T-sections bonded to a surface (courtesy George W. Whitesides Co., Inc.)

APPENDIX B TERMINOLOGY

Ambient: Usually used to describe temperature; meaning the same as the surroundings. Ambient usually, but not always, implies a temperature that is in the range of 60 to 90 F (15 to 32 C).

Broadcast: To toss granular material, such as sand over a horizontal surface so that a thin, uniform layer is obtained.

Delamination: Loss of adhesion and separation between coatings or between a coating and its substrate.

Diluent: A liquid ether which lowers the viscosity of epoxy formulations and which reacts chemically with them.

Epoxy concrete: A combination of epoxy resin and fine and coarse aggregate in a consistency similar to portland cement concrete.

Epoxy grout: A fluid epoxy compound used to fill cracks, set dowels, etc., in a manner similar to conventional grout.

Epoxy mortar: See resin mortar.

Extender: A nonreacting liquid substance added to epoxy compounds to extend pot life, increase flexibility, and lower the cost.

Flexibilizer: A substance which will react with epoxy compounds to impart flexibility.

Filler: A finely divided material, such as mica or talc, incorporated in an epoxy formulation to increase the hardness and lower the cost.

Hardener: A substance formulated so that when mixed with an epoxy resin it will cause the epoxy to solidify and harden.

Ionic: An adjective used to describe substances that dissolve to form ions. Upon dissolving, each molecule of the ionic substance splits into two or more ions. The ions always carry an electrical charge, either positive or negative. The positive and negative charges are always equal, so that the overall electrical charge is neutral.

Mil: One-thousandth of an inch.

Non-ionic: An adjective used to describe substances that dissolve without formation of ions. (See ionic)

Non-polar: Used to describe molecules characterized by a uniform distribution of electrons so that there is essentially no electrical charge, separation in the molecule. (see semi-polar)

Overlay: To apply a mortar to sufficient thickness, usually $\frac{1}{4}$ in. (6 mm) or more, to form a new surface. (see semi-polar)

Pot life: The period of time during which the epoxy compound is in a suitable condition for use.

Resin mortar: A combination of epoxy resin and fine aggregate in a consistency suitable for troweling.

Rout: To deepen and widen a crack to prepare it for patching or sealing.

Semi-polar: An adjective used to describe molecules that are intermediate between non-polar and polar types. Non-polar molecules are characterized by a uniform distribution of electrons such that there is essentially no electrical charge separation in the molecule. Polar molecules are characterized by a nonuniform distribution of electrons such that there is a difference in electrical potential from one end of the molecule to the other. Polar molecules tend to have higher solvent strength than non-polar molecules.

Stripper: A liquid compound formulated to remove coatings by chemical and/or solvent action.

Substrate: The uncoated surface upon which a coating is applied.

Thermoplastic plastic: A plastic that generally does not require curing agents and can be dissolved in a solvent or melted without permanent chemical change.

Thermosetting plastic: A plastic that, once cured, cannot be melted or dissolved in a solvent without undergoing drastic chemical change.